Pumping concrete perfectly

Versatile and manoeuvrable

LIEBHERR

31 XXT truck mounted concrete pump



31 XXT – The fold-out artist

Five-part Z-fold distributor boom and new LiDriveIn-function

Compact design



XXT-outrigger

Powerbloc inside

XXT-outrigger

The pivoting XXT support is particularly versatile when supporting in tight spaces.

Five-part Z-fold distributor boom and new LiDriveIn-function

The short arms and low unfolding height make the 31 XXT uniquely flexible for indoor use. The new LiDriveIn-function allows entry into a hall with low height.

Powerbloc inside

The Powerbloc concrete pump drive, developed and manufactured by Liebherr, combines power and smooth running, made by Liebherr.



Highest safety and ergonomics

Storage capabilities

Compact design

Compact assembly with no overhang ensures manoeuvrability and transparency.

Highest safety and ergonomics

All control stations are ergonomic and meet the highest safety standards.

Storage capabilities:

Variable and secure storage of accessories.

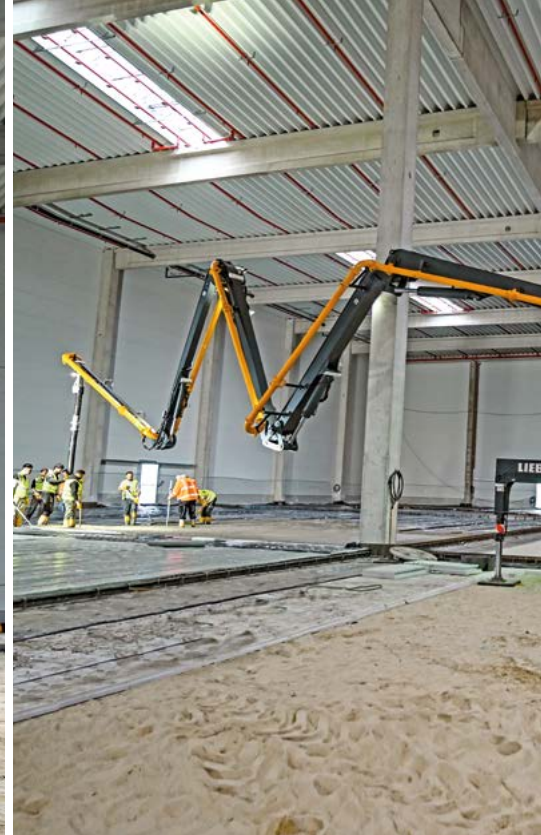

Unfolding height

With an unfolding height of the boom of only 5.4 meters, concreting in confined spaces or halls is no obstacle for the machine.

Highlights

Compact design

The 31 XXT truck mounted concrete pump is mobile, manoeuvrable and also very versatile in its application possibilities. The pump shows its great potential especially in construction work with restricted working areas. The compact design noticeably increases manoeuvrability on the construction site and in road traffic. This is a great added value, especially in inner-city areas.

Boom concept

The five-part distributor boom in Z-fold and the good slip properties allow maximum flexibility at the construction site. A wide variety of positions can thus be reached perfectly at the construction site. The design of the boom ensures quiet and vibration-free operation even at high delivery rates.

Flexibility

The five flexible arms paired with the proven XXT support make the 31 XXT particularly suitable for confined construction sites and concrete works that require a low unfolding height. The low unfolding height of only 5.4 m opens up a wide range of challenging applications such as working in existing buildings, tunnels and halls as well as bridge construction.

Robustness

The robust design of the machine ensures reliable operation for many years at low operating costs. Numerous design details facilitate tough everyday use.

Narrow distributor boom

The very narrow arms 3,4 and 5 offer excellent slip properties through narrow openings in buildings.





Slip properties

Good slip properties facilitate concreting in existing buildings on different floors.

LiDriveIn: Hall drive, efficiency and safety redefined

Advanced technology for effortless and safe entry into buildings

The 31 XXT can enter a building in standard operation with the arm package folded in front of the driver's cab thanks to LiDriveIn. The LiDriveIn function is simple and safe. The support legs are moved down without swinging out. The swivel range thus released makes it possible to position the distribution boom in front of the driver's cab. The machine can thus enter at walking speed through an opening in a building as small as 4 m high. Less effort, more security and more efficiency.

Adaptable support configurations

Entirely in accordance with the individual construction site conditions, a choice can be made between different support configurations after entry into the building. LiDriveIn in combination with our proven XXT support offers absolute adaptability to the respective spatial conditions – maximum flexibility guaranteed.

Easy handling in buildings

In the building, the short arm segments and the low unfolding height of only 5.4 m allow the machine operator to easily unfold the distribution boom in front of the driver's cab. The 31 XXT thus gains additional room to move in the building, while at the same time the maximum horizontal reach of the machine can be used via the driver's cab.



QR-Code LiDriveIn



No space? – No problem!



XXT-outrigger

Perfect in every situation

The XXT support transfers the boom loads along the shortest path to the contact areas of the support legs. No forces act on the vehicle frame. On each side of the vehicle, the front and rear support legs swivel around the same axis to save space.

Narrow support

The XXT-outrigger offers great advantages compared to other supports: Nonetheless, even on the side where there is little space, the front support can still be extended in front of the driver's cab thanks to the swivel option. This adds the entire working area in front of the driver's cab. Even with narrow support on both sides, work is possible across the driver's cab.

Partial support

The versatile XXT support is unbeatable when supporting in tight spaces. The big advantage: In particularly cramped situations with little space, it is possible to work in the side area despite partial support with boom arm 1 raised. Pumping can always be carried out across the cab with the boom fully extended.

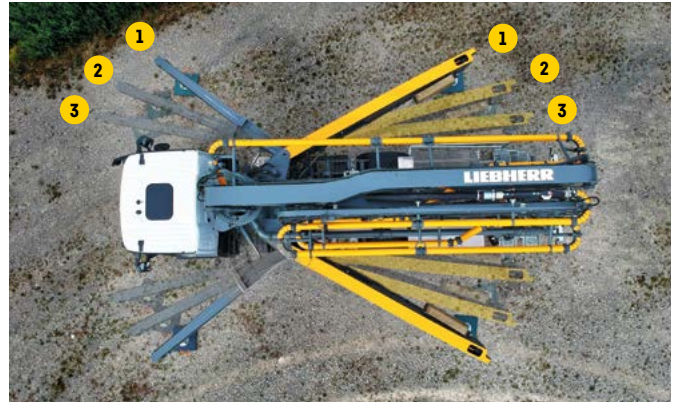

1. Full support
2. Partial support
3. Narrow support

XXA stability control system

Thanks to the new XXA stand safety control, partial support areas are made possible and electronically monitored. Thus, the new stability offers even more application possibilities due to the multitude of additional support options and at the same time ensures safe working in every situation. The approved slewing range of the boom is indicated on the radio remote control in the colour display.

- Full support, boom can be fully extended
- Partial support, boom arm 1 raised

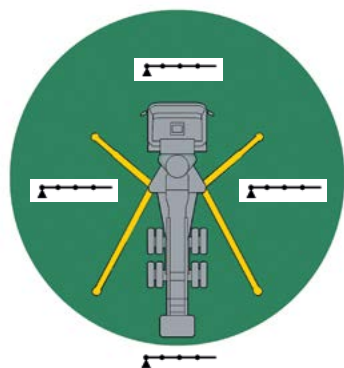

Full support

The innovative XXT support gives the truck mounted concrete pump maximum stability at all times. Supporting is quick, even on uneven terrain.

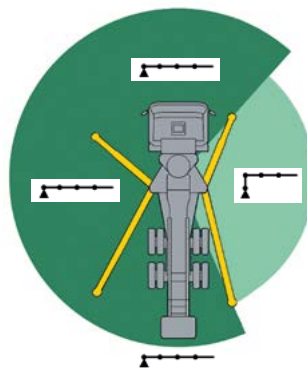

Single-side partial support

In the partially supported area, work can also be carried out on this side with boom arm 1 raised.

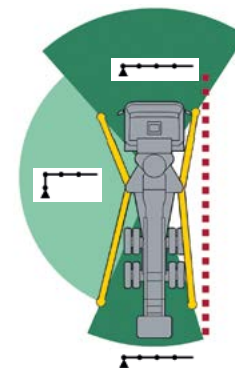

Combination of partial and narrow support

The combination of partial and narrow support on one side enables a large variable slewing range for the boom with minimum space requirement.

Powerbloc and HCC

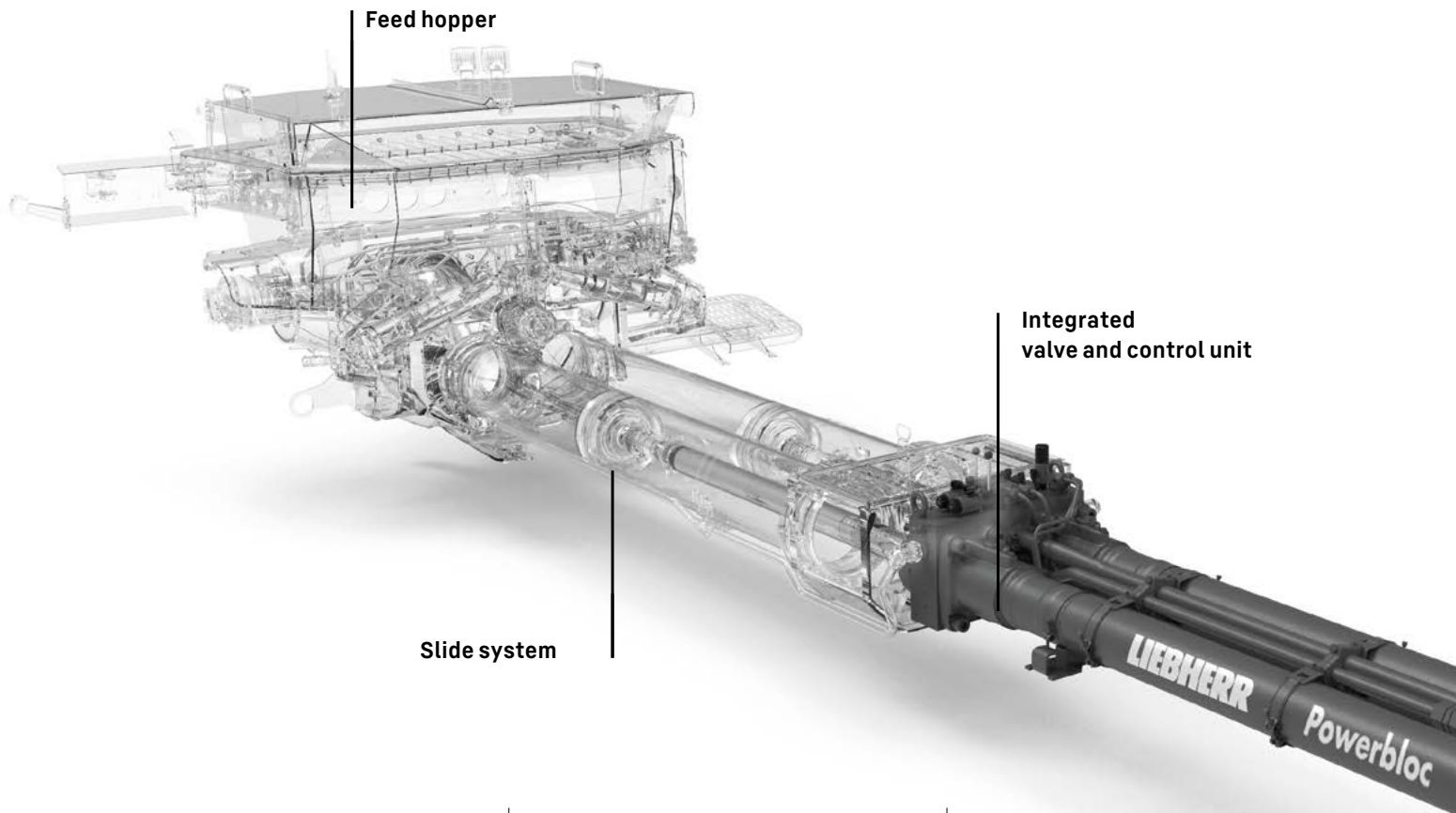

| Concrete pump | THP 140 Powerbloc | THP 170 Powerbloc |
|---|--------------------------|--------------------------|
| Max. flow rate (piston side) | 144 m ³ /h | 167 m ³ /h |
| Max. concrete pressure (piston side) | 80 bar | 80 bar |
| Pump cycles (piston side) | 29 min ⁻¹ | 34 min ⁻¹ |
| Conveyor cylinder Ø x stroke | 230 mm x 2000 mm | 230 mm x 2000 mm |
| Concrete conveying volume / double stroke | 166 L | 166 L |
| Max. hydraulic pressure | 350 bar | 350 bar |
| Drive cylinder | 110 mm / 80 mm / 2000 mm | 110 mm / 80 mm / 2000 mm |
| Hopper capacity | 600 L | 600 L |

Powerbloc

The Powerbloc is characterized by high performance and smooth running. The latest drive unit for concrete pumps does not require a separate control block, as all hydraulic switching and measuring elements are integrated.

Feed hopper

The optimized hopper shape promotes concrete flow and reduces concrete deposits. The separate agitator paddles and the wide suction openings guarantee optimum suction performance. The feed hopper enables easy cleaning due to good accessibility.

Slide system

Powerful slide system with smooth change of direction thanks to controlled pipe changeover. The controller controls the oil quantity perfectly matched to the switchover cycles. The S-pipe changeover is implemented via two hydraulic cylinders with full pressure from the main hydraulic pump.

Powerbloc

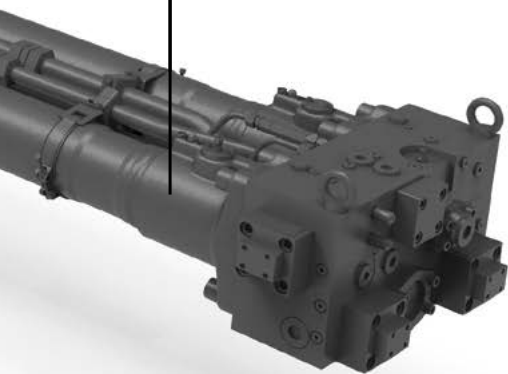

QR-Code Powerbloc

HCC

Semi-closed oil circuit

The innovative Powerbloc drive unit is complemented by a newly designed, highly efficient semi-closed oil circuit. This guarantees that all drives are permanently supplied with reliable and powerful hydraulic power.

The new Liebherr own system combines the advantages of the proven open and closed hydraulic systems currently on the market, without their disadvantages. The system operates without a storage pump and without a reservoir. The required oil volume is significantly reduced, which saves costs and weight.

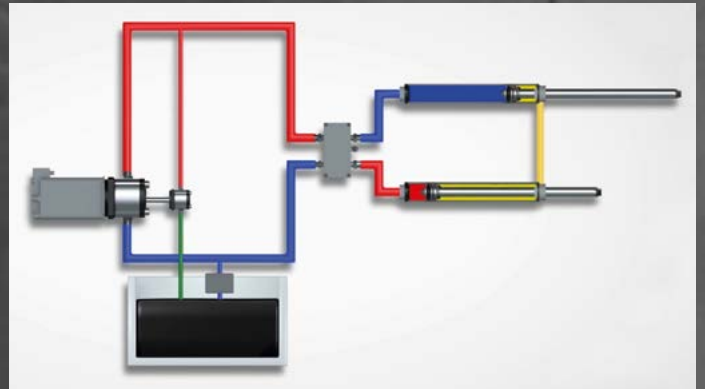

QR-Code HCC

Equipment and accessories

Practical hose and piping storage

The new hose and piping storage system allows the best possible adaptation to customer requirements and ensures convenient and safe storage.



Secure with safety

New hose and piping storage

The new hose and pipe line rack offers an efficient and uncomplicated solution for storing hoses and pipe lines up to a size of DN125. The pipe magazines, made of robust PE, not only ensure safe storage but also excellent accessibility.

In addition to the hose magazines on the outrigger legs, there is another hose and pipe magazine on the inside of the outriggers and a generous aluminium tray on the left side. With this innovative hose and pipe storage system, up to 90 metres of pipes and hoses can be stored and transported. Everything is always at hand and extremely flexible.



QR-Code configuration options for hose and piping storage

Our truck mounted concrete pumps have:

- Large treads and platforms
- Height-adjustable steps on the left (ergonomics)
- Good accessibility and ergonomic arrangement of the control stations
- Full railings and fall protection devices
- A broad LED lighting concept for work in poor lighting conditions or work at construction sites at night
- Illumination of the control stations
- Radio remote control with flashlight function and control panel illumination as well as vibration alarm and emergency stop function in case of a fall (dead man's switch)

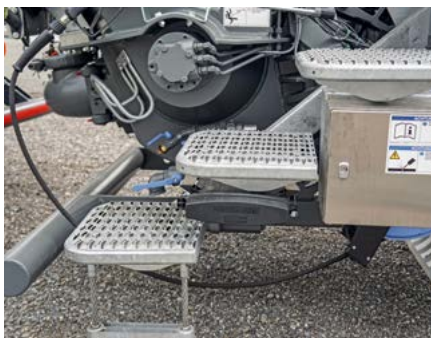

Spacious treads and platforms

Spacious steps for safe access to all control points on the machine and for cleaning the feed hopper.



Signal light

Signal light on the concrete boom for visual status display of the XXA stability control system at the construction site.



Remote control

The radio remote control informs the operator about all important machine data.

Safety is our top priority

We are committed to the applicable safety rules. In the development of Liebherr truck mounted concrete pumps, safety for people and the machine is the top priority. We observe our machines in use and continuously improve them.

Always on the safe side with XXA

The XXA stability control monitors the approved slewing range of the boom as well as the correct positioning of the machine.

Digital inclination monitoring

The safety of man and machine is ensured thanks to the digital inclination monitoring. When setting up the machine, the machine tilt is monitored. The two-stage inclination monitoring even allows excessive tilting of up to 5° under restricted operating conditions and alerts the machine operator and the surrounding area of the construction site via radio display and signal light.

Safe working in any situation:

- Digital inclination monitoring
- Traffic light on the boom for additional visualization of the machine status at the construction site

Note: The XXA stability monitoring with inclination monitoring is standard on delivery to the EU.

Technical data 31 XXT

3-axle chassis

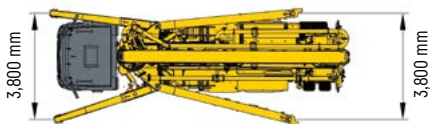
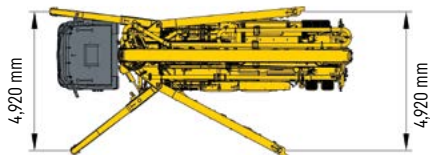
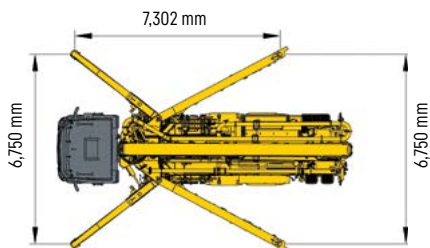
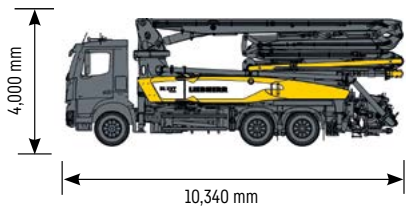

1. Full support
2. Single-side narrow support
3. Combination of partial and narrow support

4-axle chassis

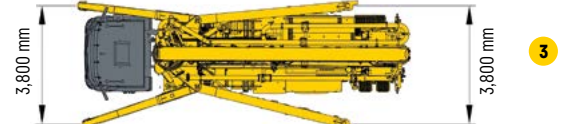
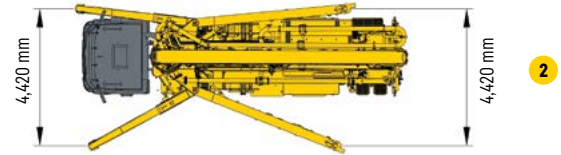
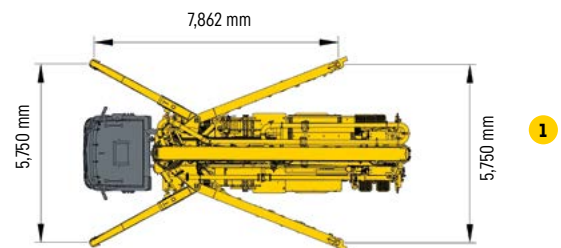
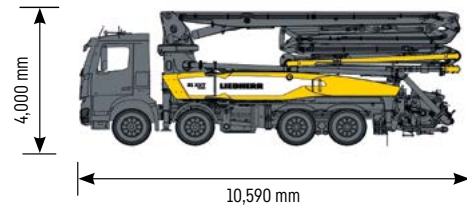

The LiDriveIn-function is only available in combination with a 4-axle chassis.

Boom

31 Z5

| | |
|------------------------|--------|
| Vertical range | 30.6 m |
| Horizontal range | 26.4 m |
| Unfolding height | 5.4 m |
| Swivel range | 365° |
| Angle range of arm 1 | 96° |
| Angle range of arm 2 | 180° |
| Angle range of arm 3 | 245° |
| Angle range of arm 4 | 180° |
| Angle range of arm 5 | 245° |
| Conveyor line diameter | 125 mm |
| End hose length | 4 m |
| Voltage | 24 V |

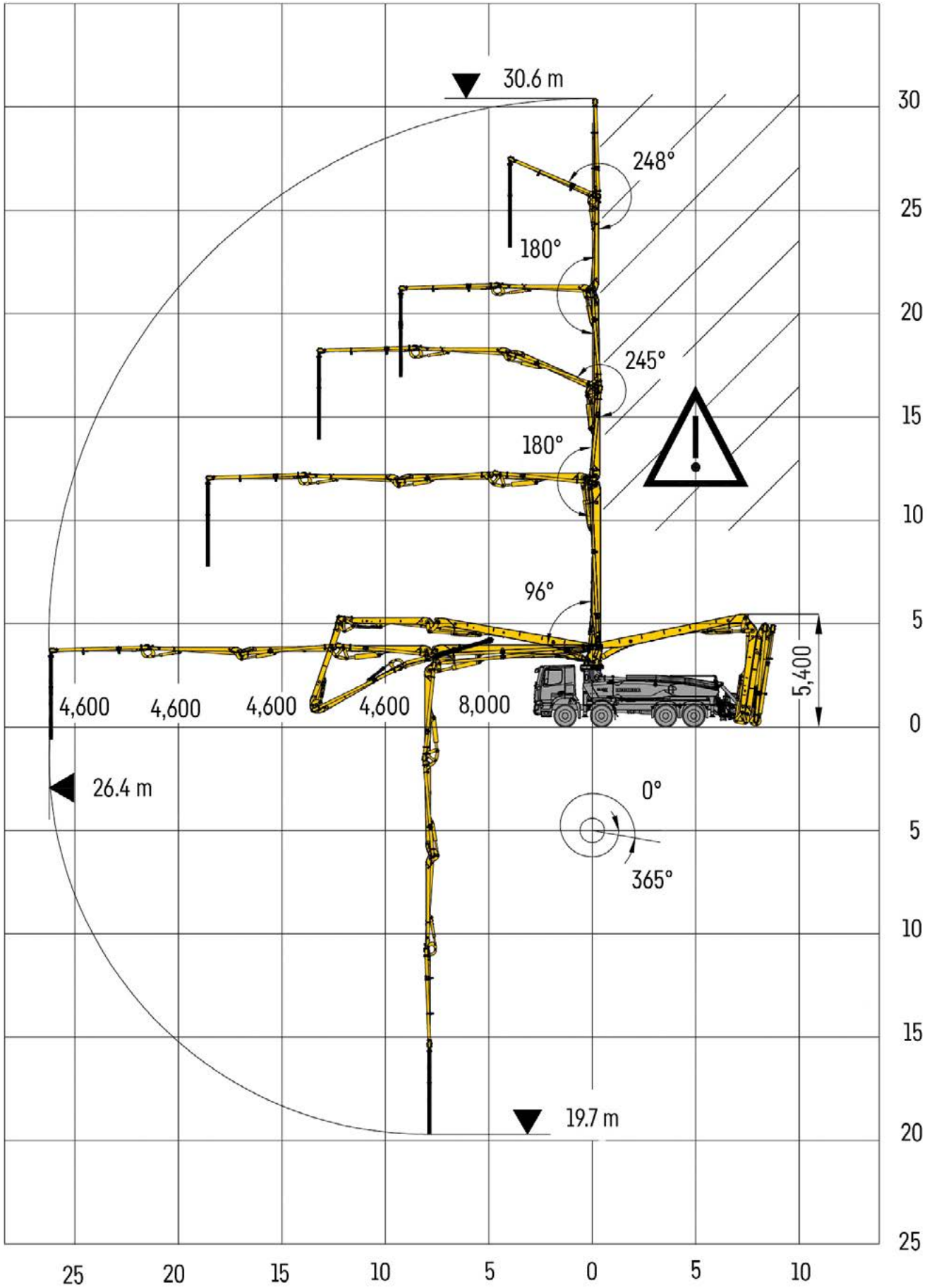

Customer service



Service out of conviction

Good service means close customer proximity

With our professional service network, we are at your disposal with rapid response times to ensure high machine availability. Reliable machines are the guarantee for your success. Our highly trained service personnel make sure your Liebherr truck mounted concrete pumps operate economically and seamlessly. We help with start-up machine operator instruction and by answering your questions.

Liebherr service partners worldwide

Our customers can rely on a worldwide service network consisting of over 90 service centres (Liebherr companies/partners), 160 service vehicles and 220 qualified service technicians. Our worldwide service centres with all contacts can be found on the Liebherr website or in the MyLiebherr customer portal.



Service-friendly design

During construction, great importance was attached to ease of service. Wearing parts are easy to replace, important areas are easily accessible.



Our customer portal – MyLiebherr

MyLiebherr is your entry into the Liebherr service world. Through the Liebherr customer portal, our customers benefit from comprehensive service and additional benefits.



Original Liebherr spare parts

Original Liebherr spare parts are subject to strict quality controls, are quickly available worldwide and guarantee reliable operation and a long service life.

We are here for you!

Personal. Capable. Reliable.



Concrete pumps



Mixing plants



Truck mixers



Conveyor belts



Measuring technology



Mixing systems



Concrete recycling systems

Your powerful partner.

- Delivery and instruction by experienced service technicians
- Worldwide service network with over 90 service centres
- Technical support worldwide
- Fast availability of spare parts
- Professional maintenance and services

Liebherr-Mischtechnik GmbH · Postbox 145 · 88423 Bad Schussenried, Germany
+49 7583 949-0 · www.liebherr.com · info.lmt@liebherr.com

**Get your
contact**

