

Liebherr PR 776

HTL Anichstraße 2015/16

Schüler: Lukas Aichner, Julian Beller,  
Ivan Juric, Deniz Kahraman,  
Peter Kammerlander, David Kerber,  
Marco Kössler, Angelo Libertino, Bernhard  
Lindner, Lukas Niederscheider, Martin  
Reindl, David Schguanin,  
Fabio Schramm, Michael Stöckl,  
Florian Vouk, David Walter  
Klasse: 3BHM/BT  
Lehrpersonen: Michael Grif, Jörg Knofler  
Beratung: Albert Nindl  
Initiator: Johannes Mayr

1

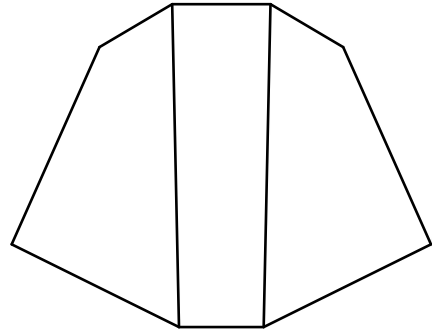

7a

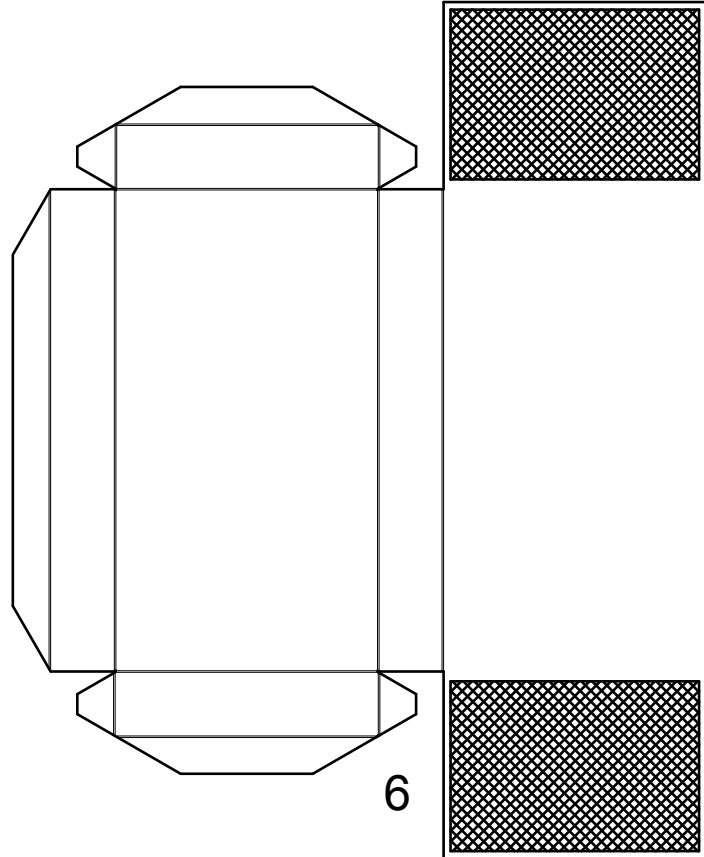
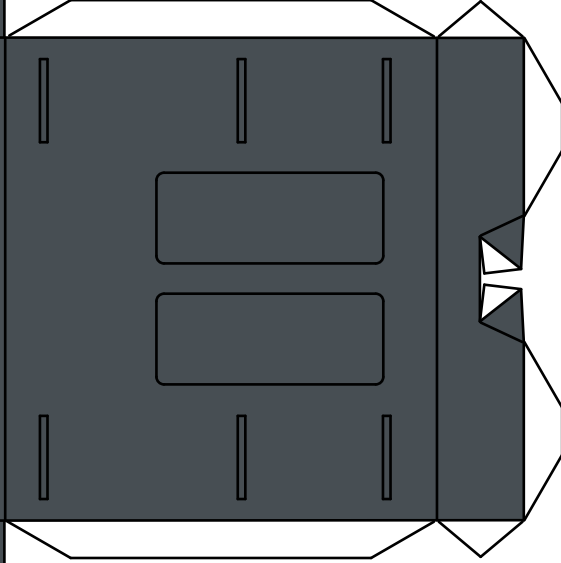

6

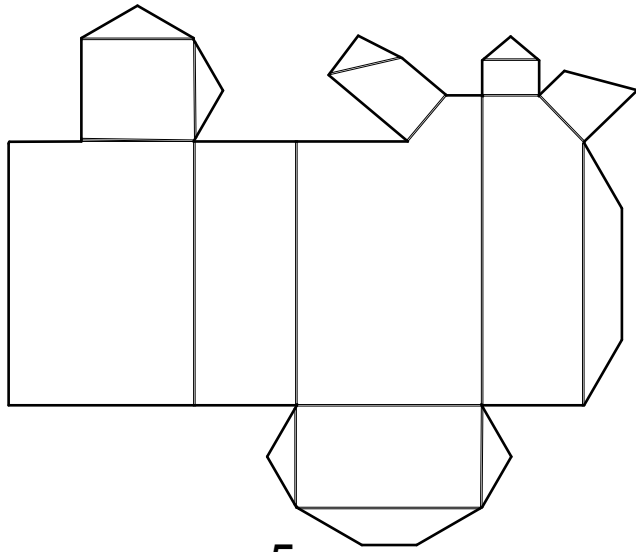

5

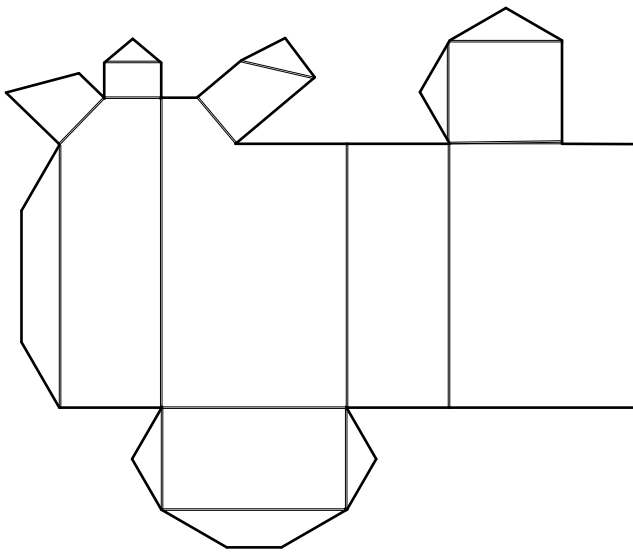
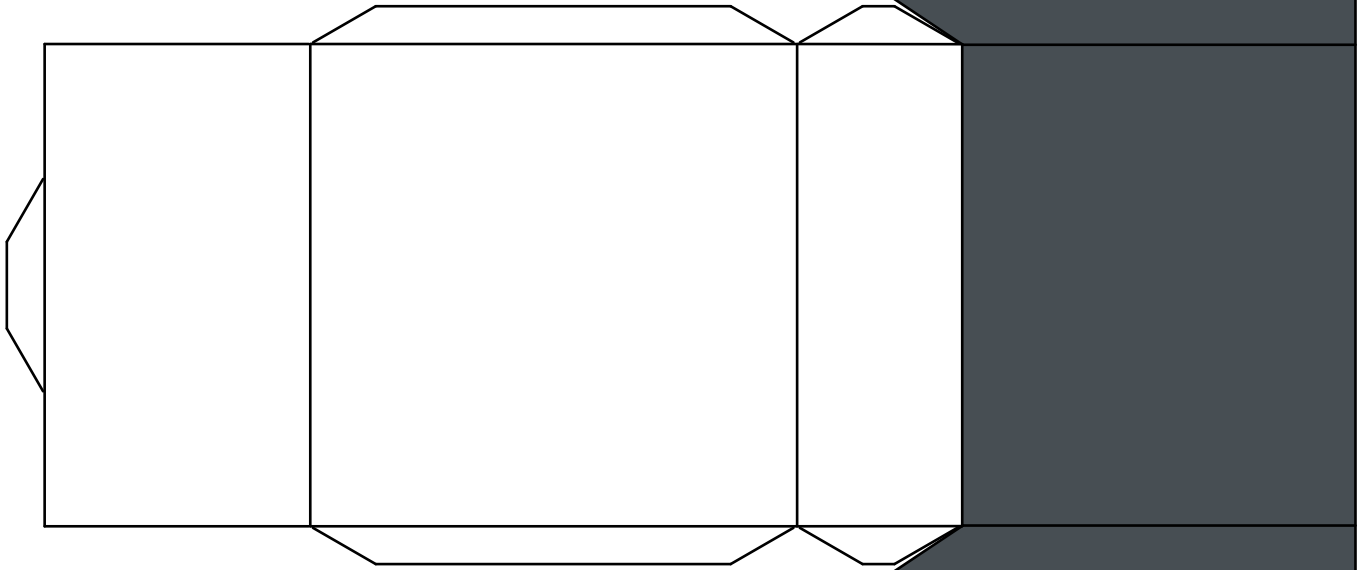
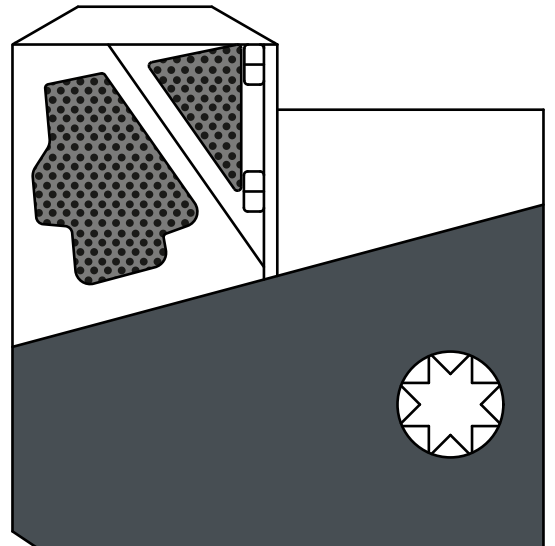

4

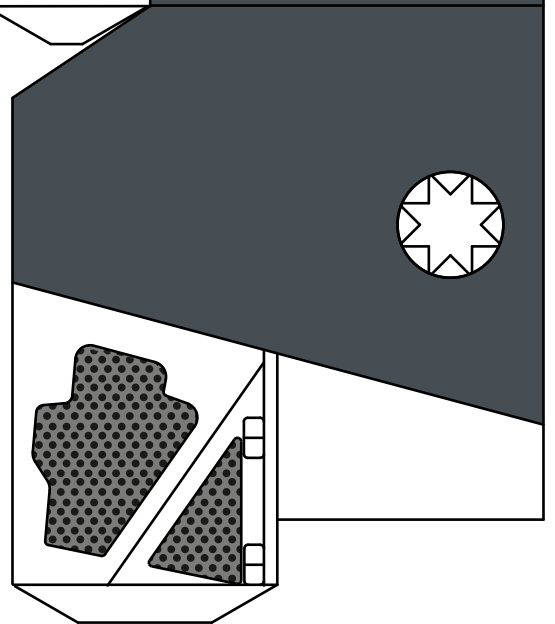

2

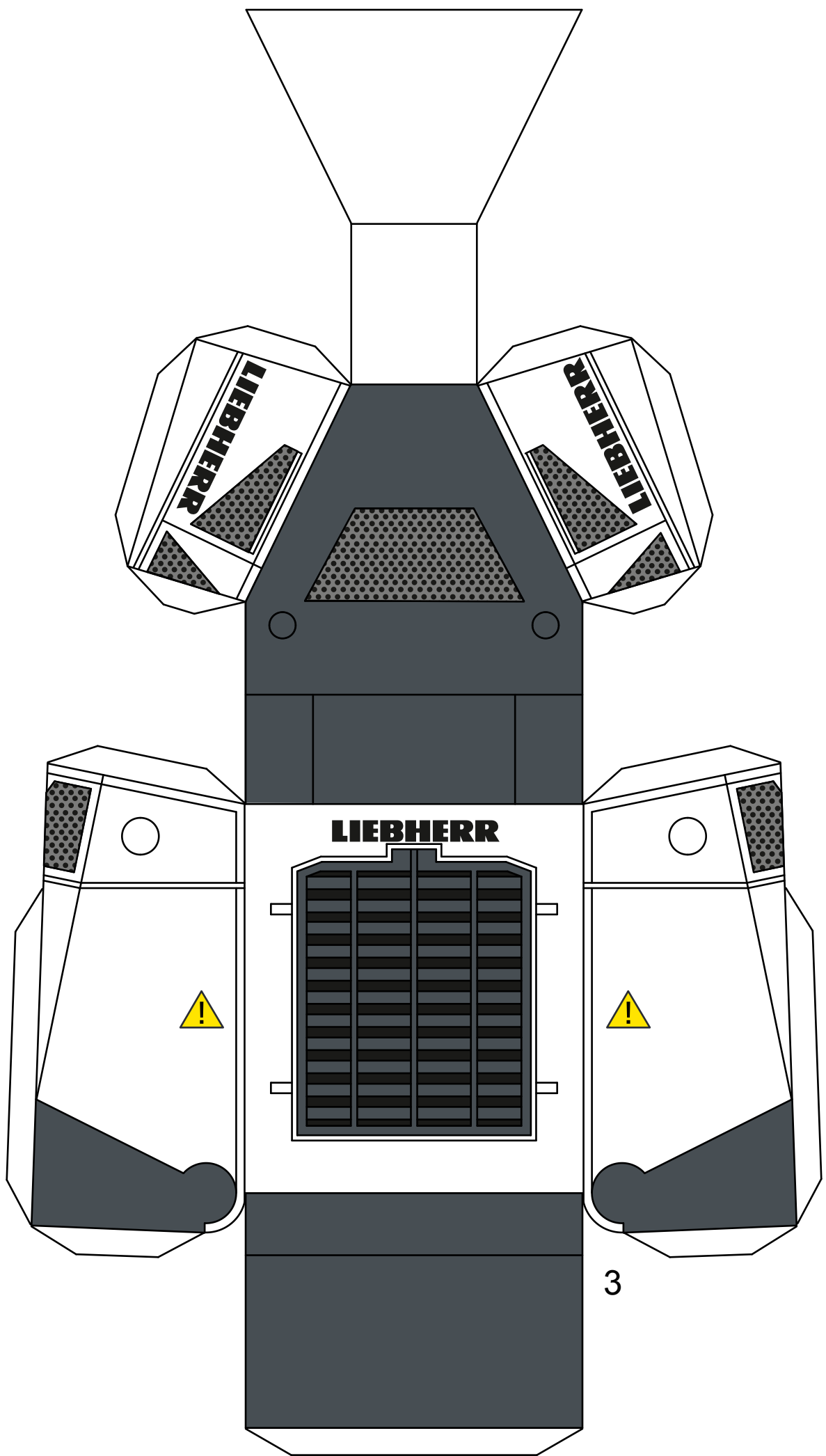

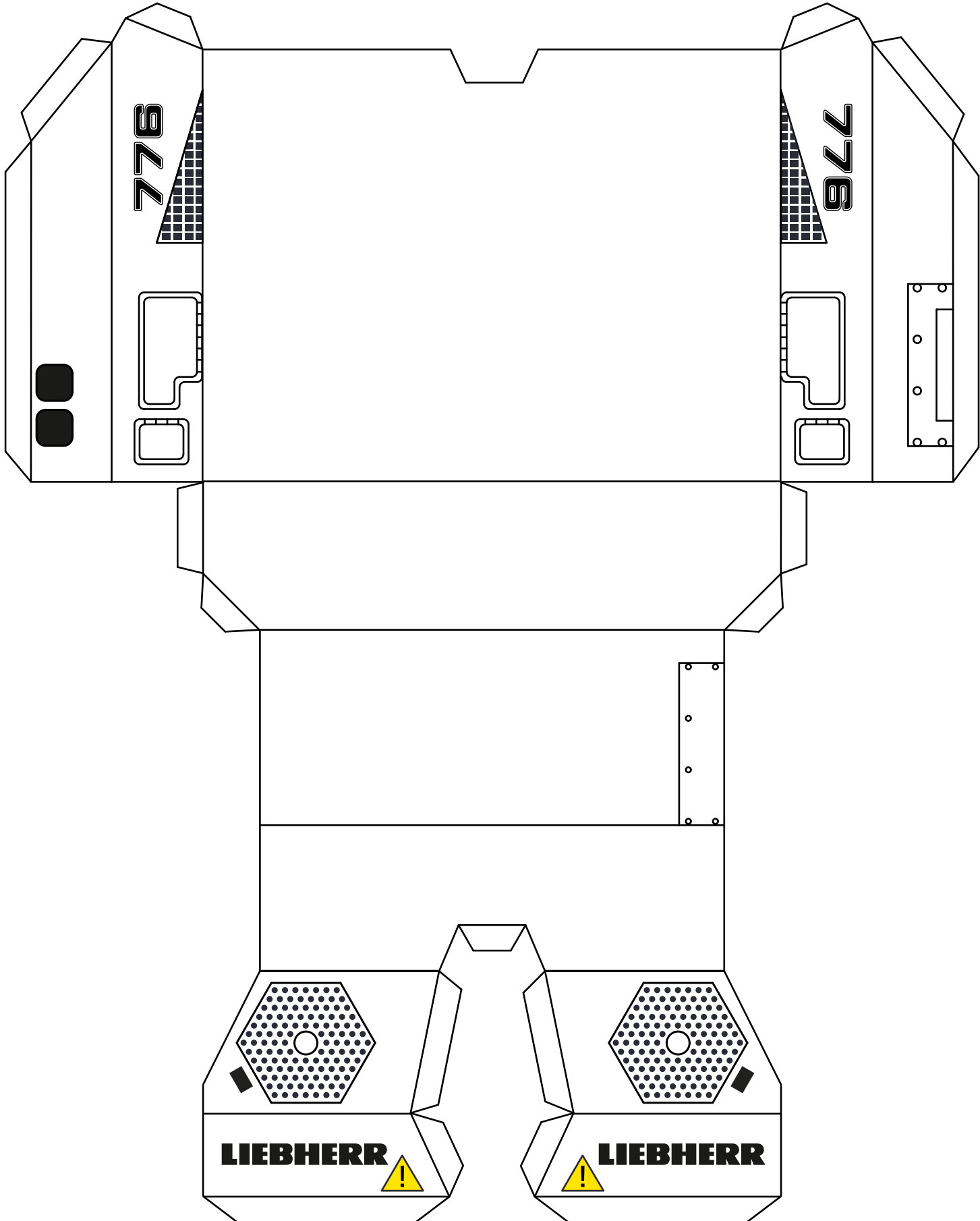

9

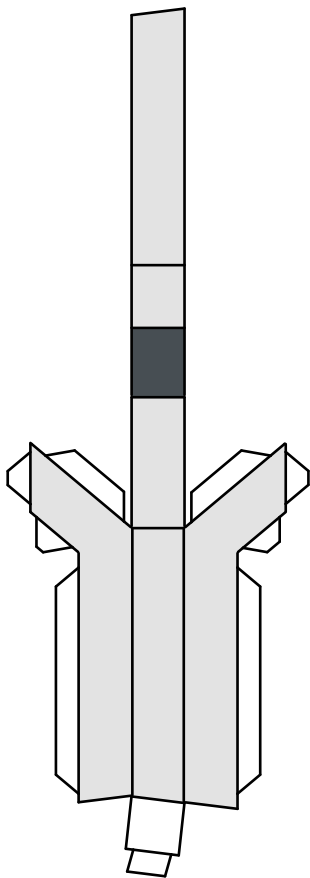

8

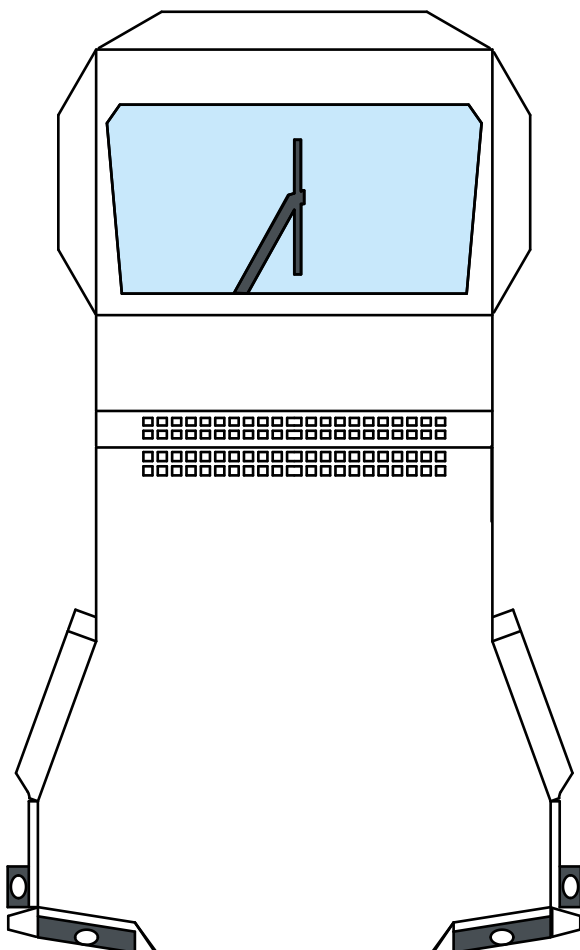

10

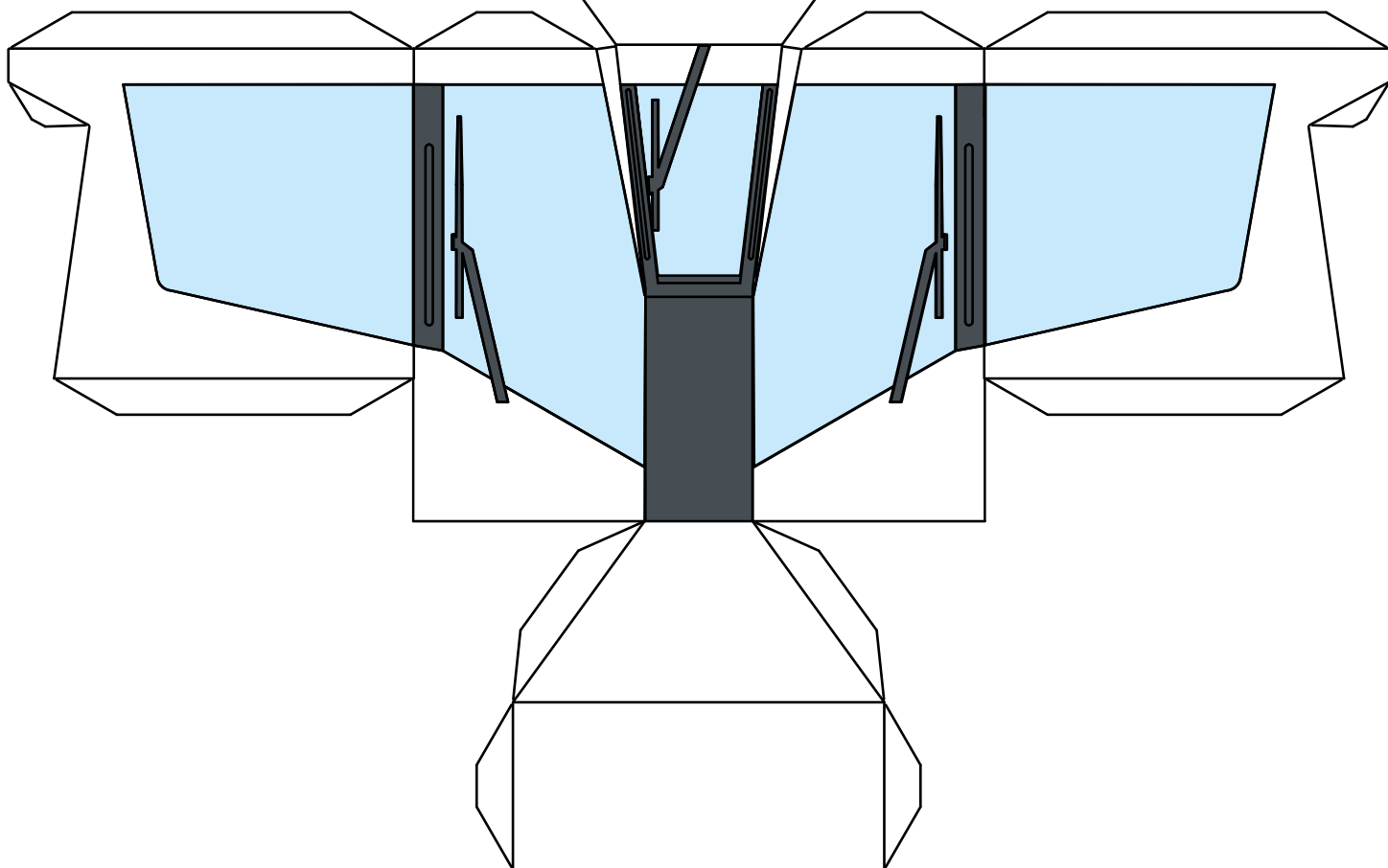
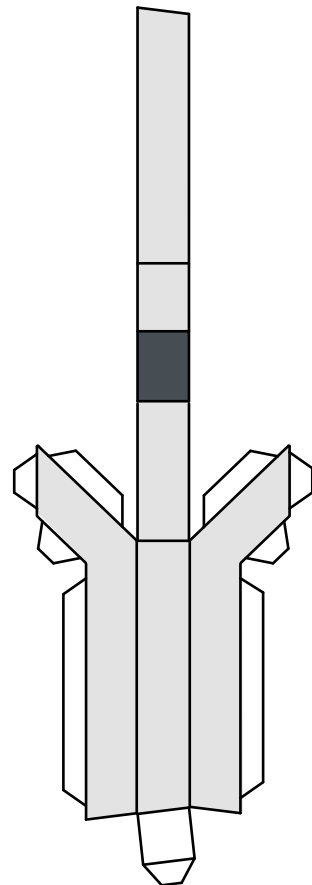

11

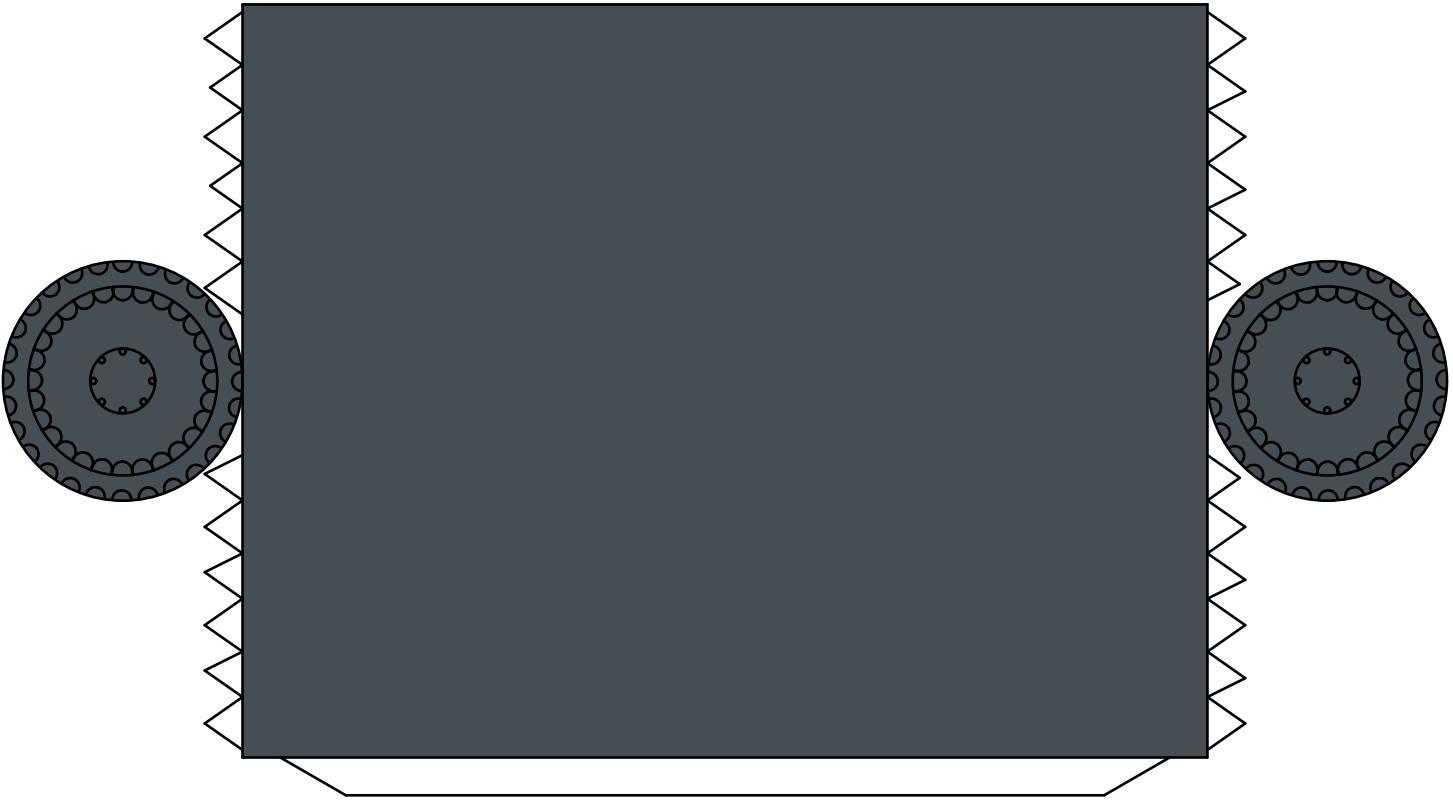

12

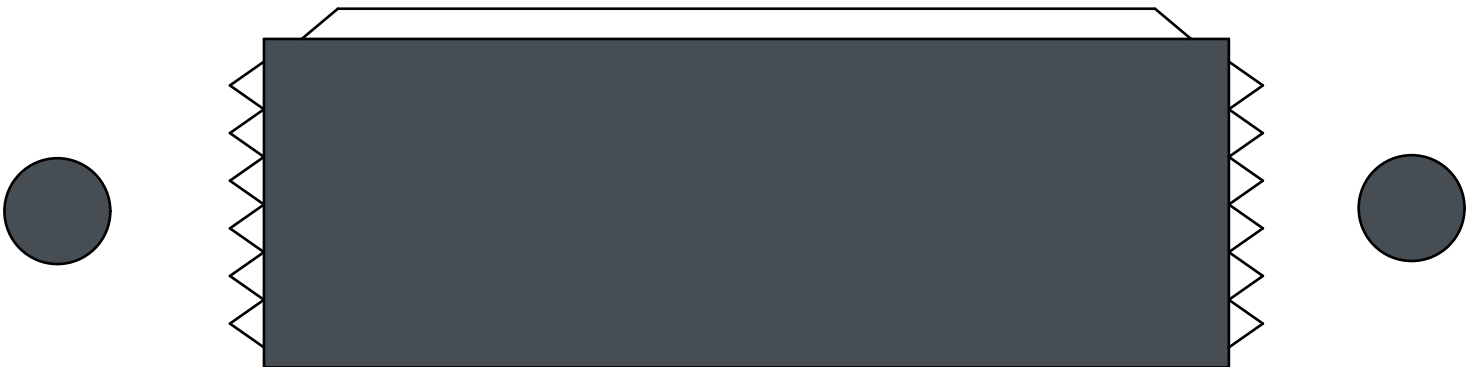

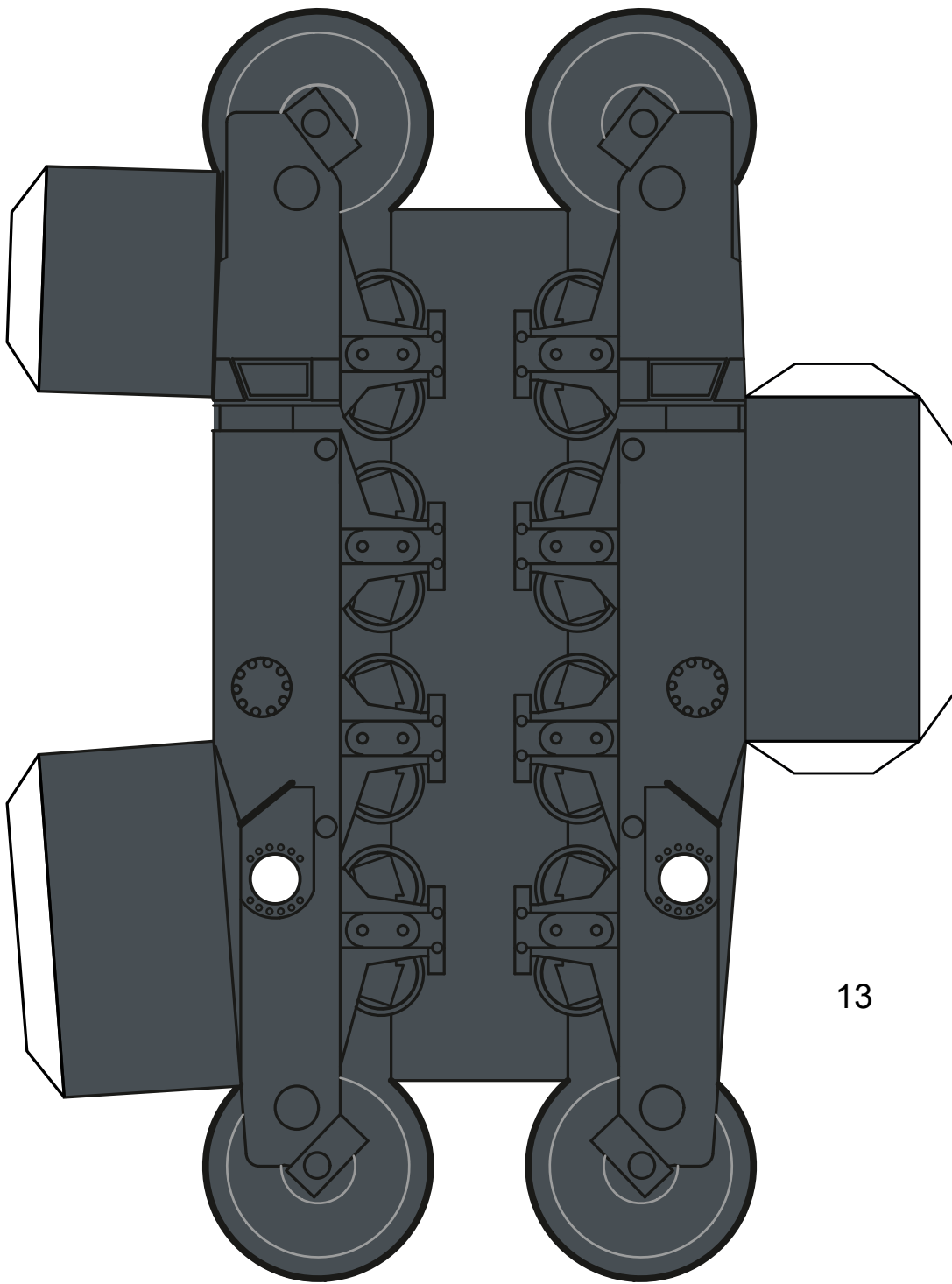

13

13A

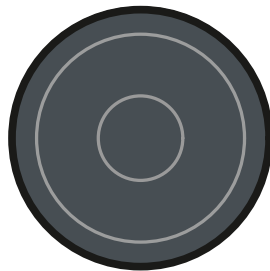

13B

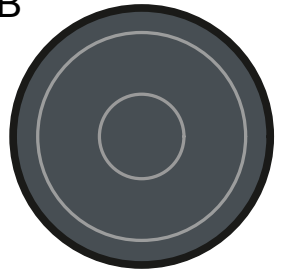

13D

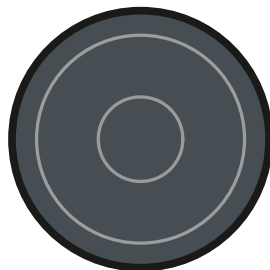

13C

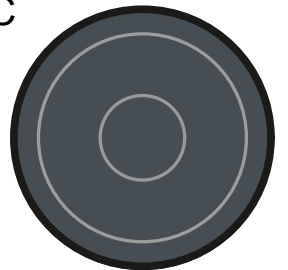

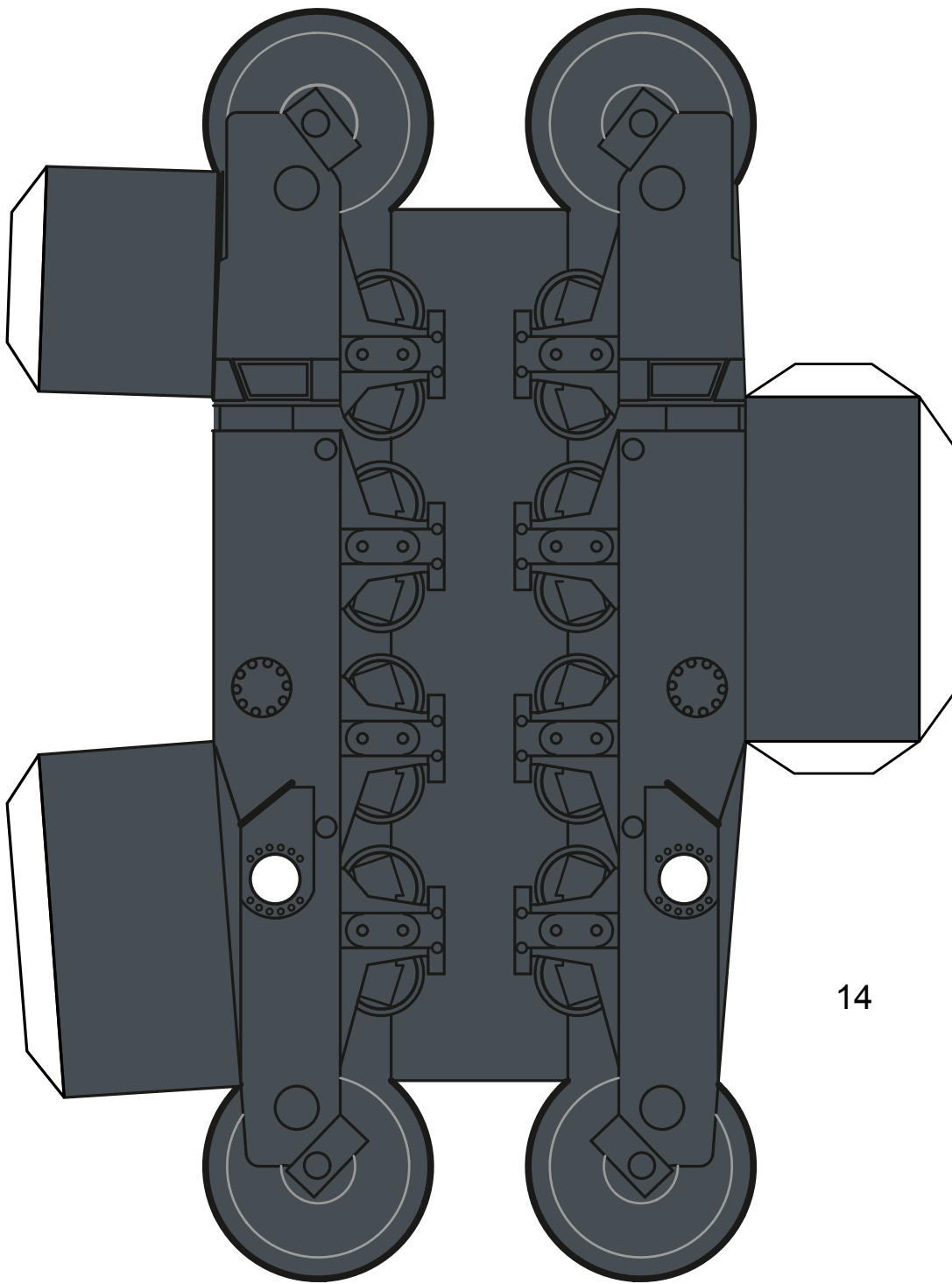

14

14A

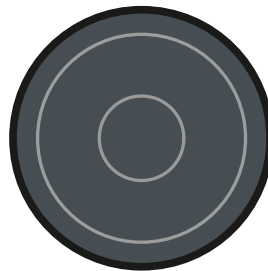

14B

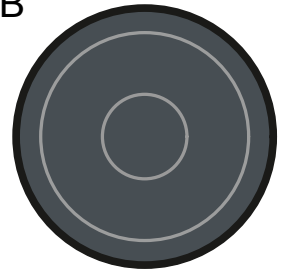

14D

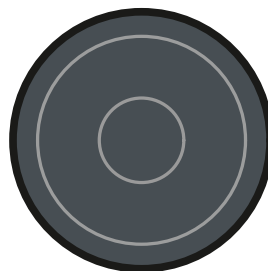

14C

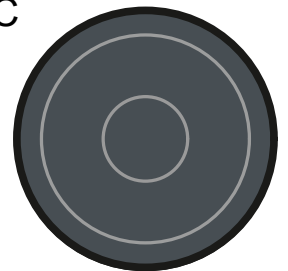



16A

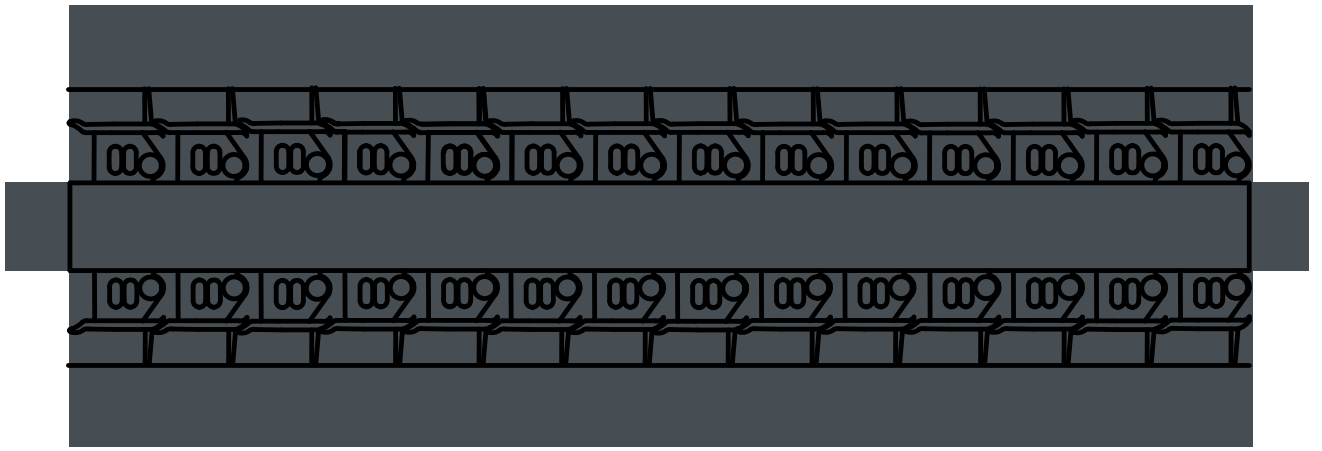

15A



20A

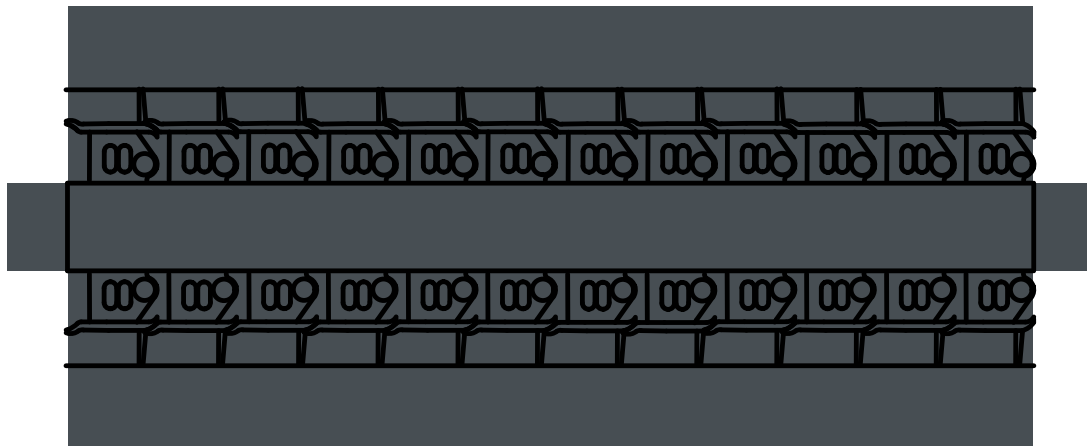

19A



16B

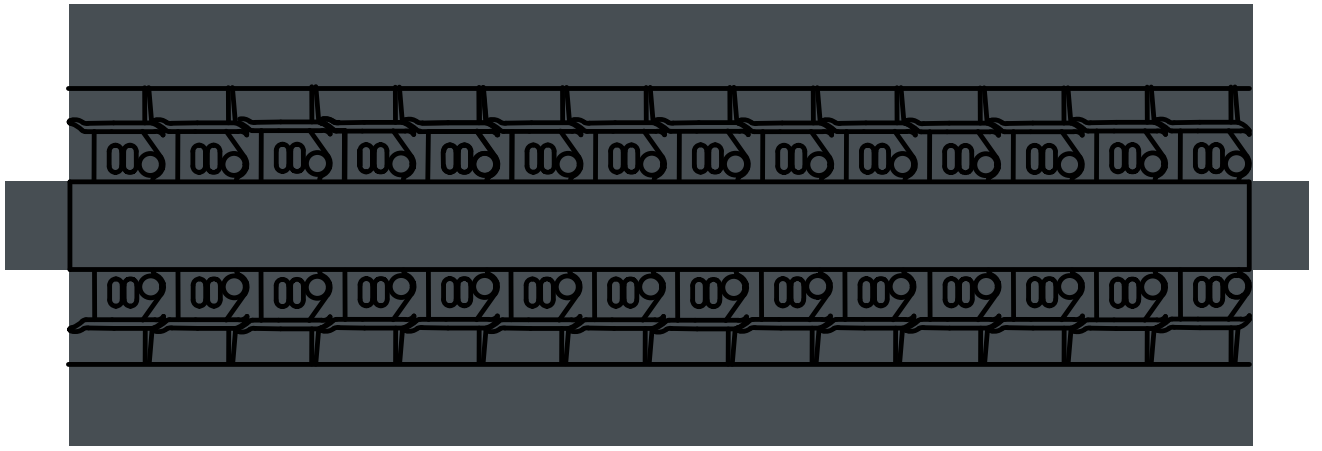

15B

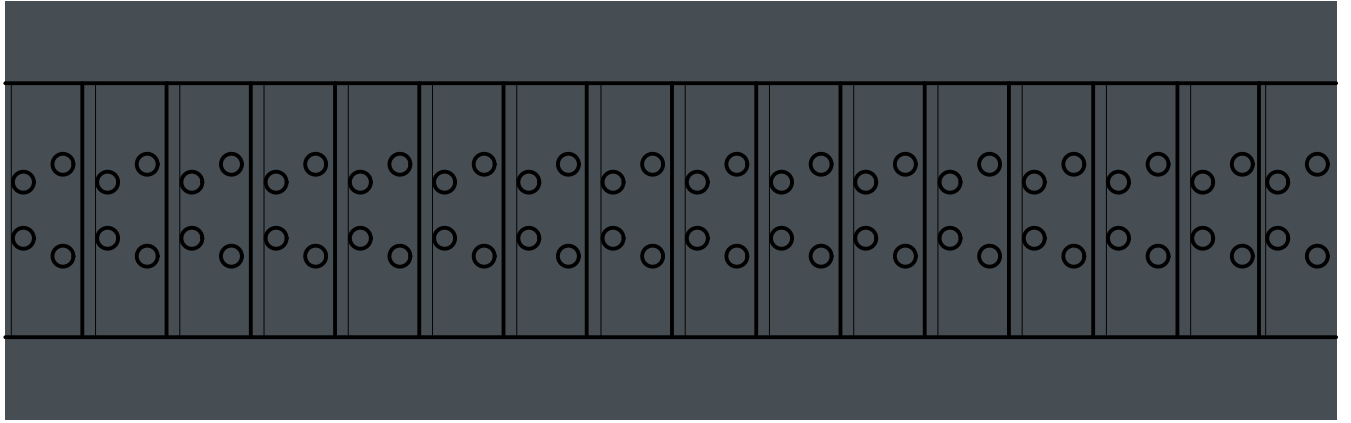

20B



19B



18A

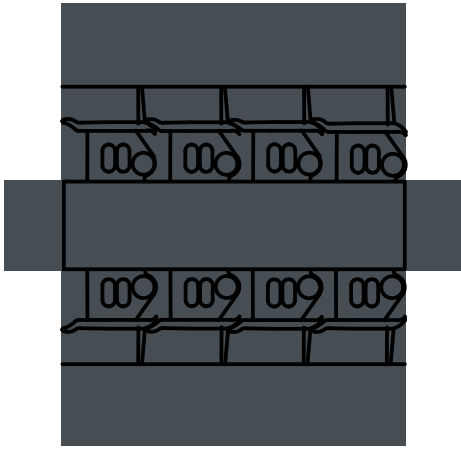

17A

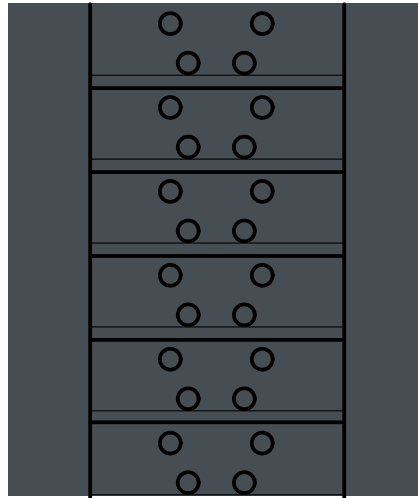

18B

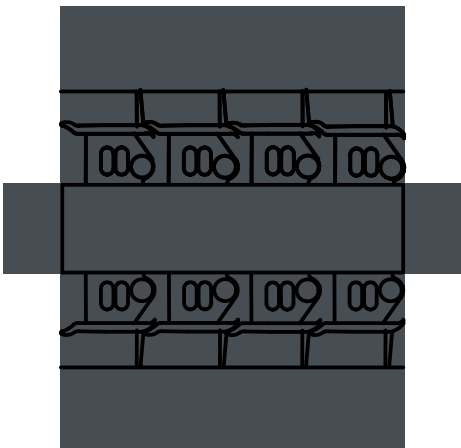

17B

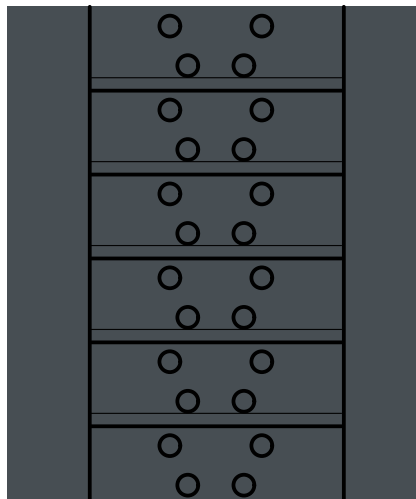

24A

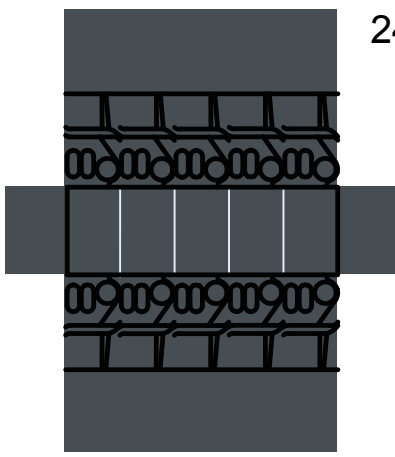

26A

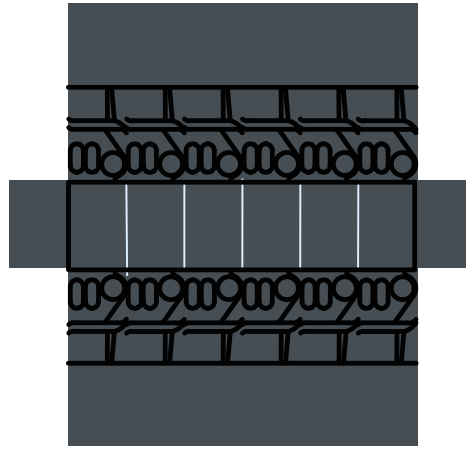

22A

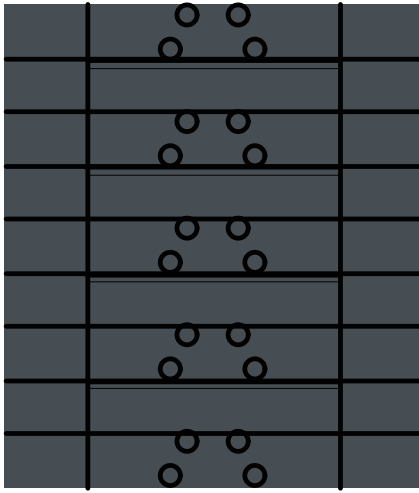
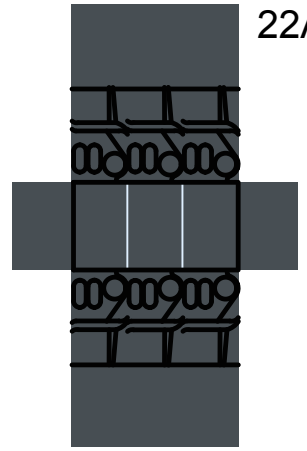

23A



25A

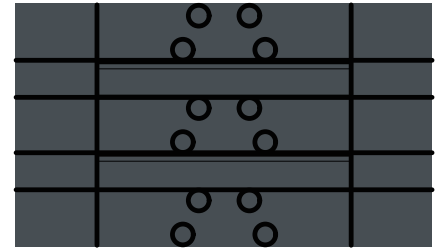

21A

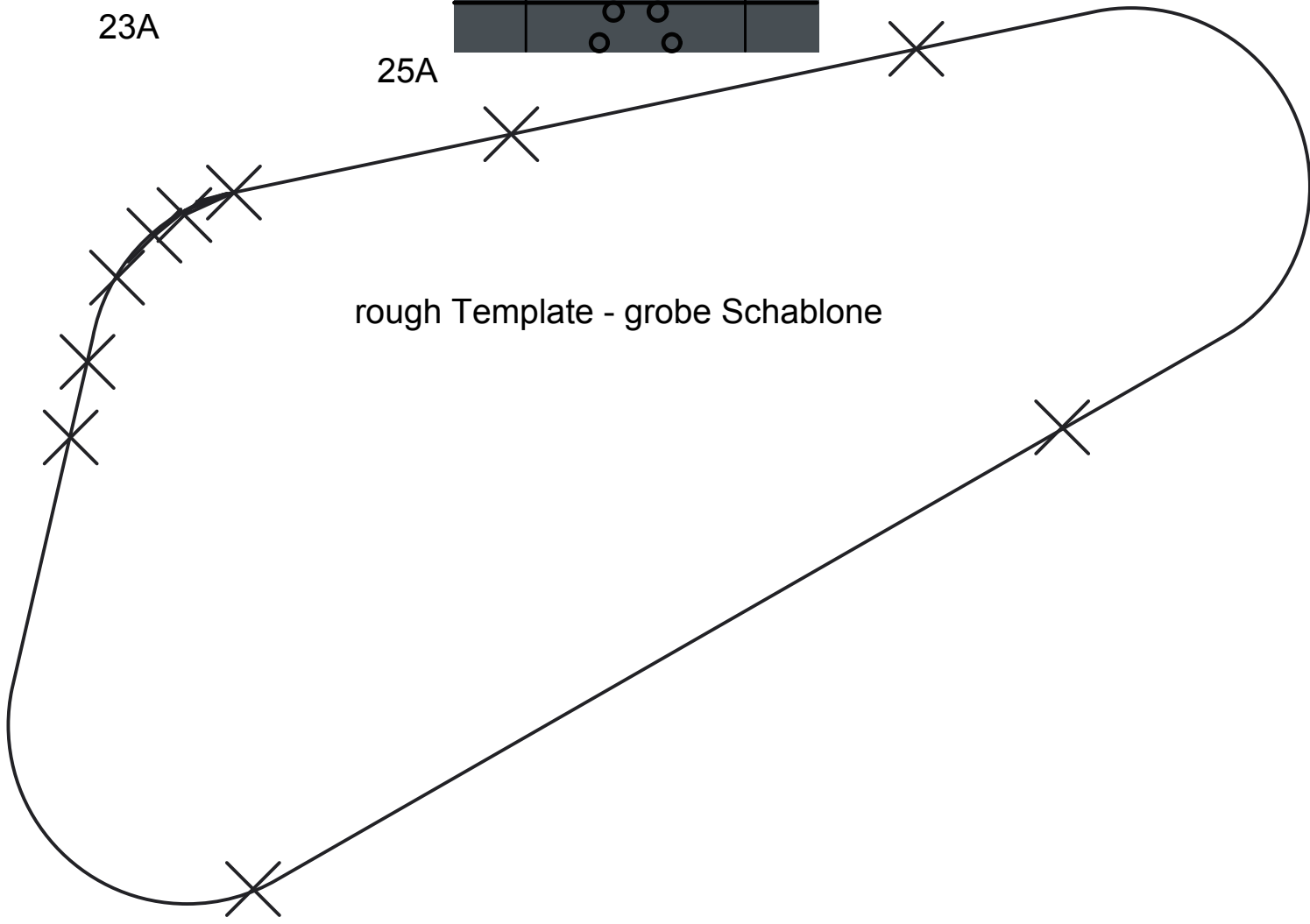

rough Template - grobe Schablone

24B

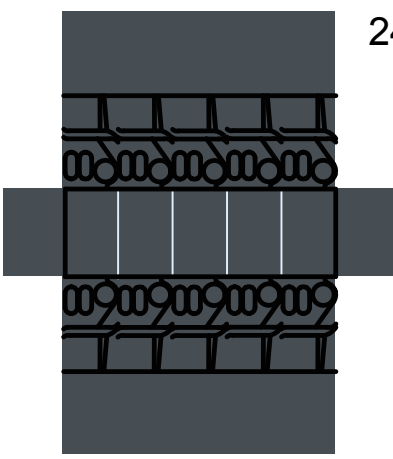

26B

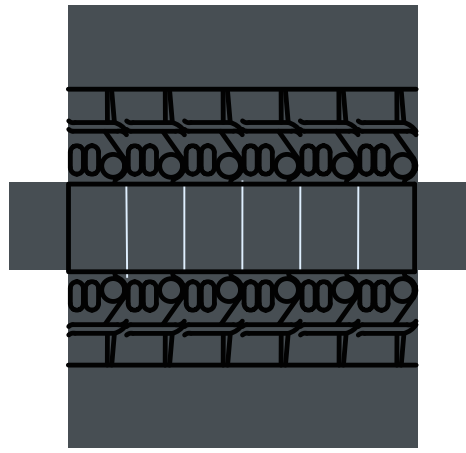

22B

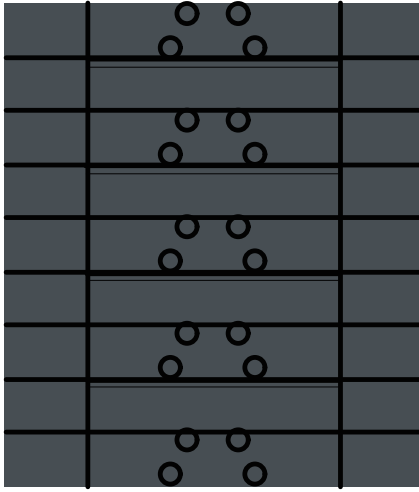
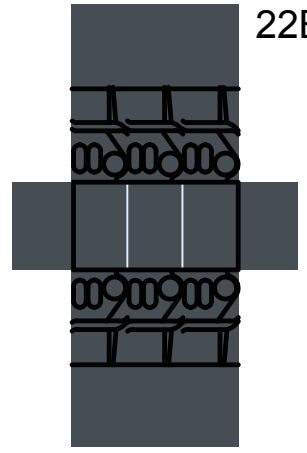

23B

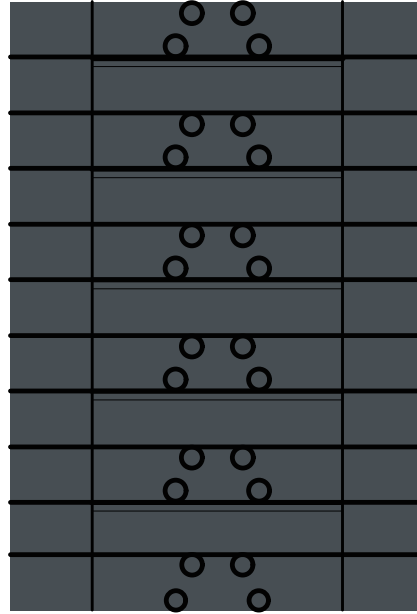

25B

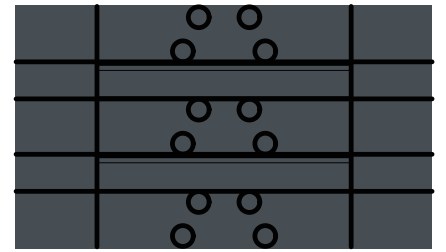

21B

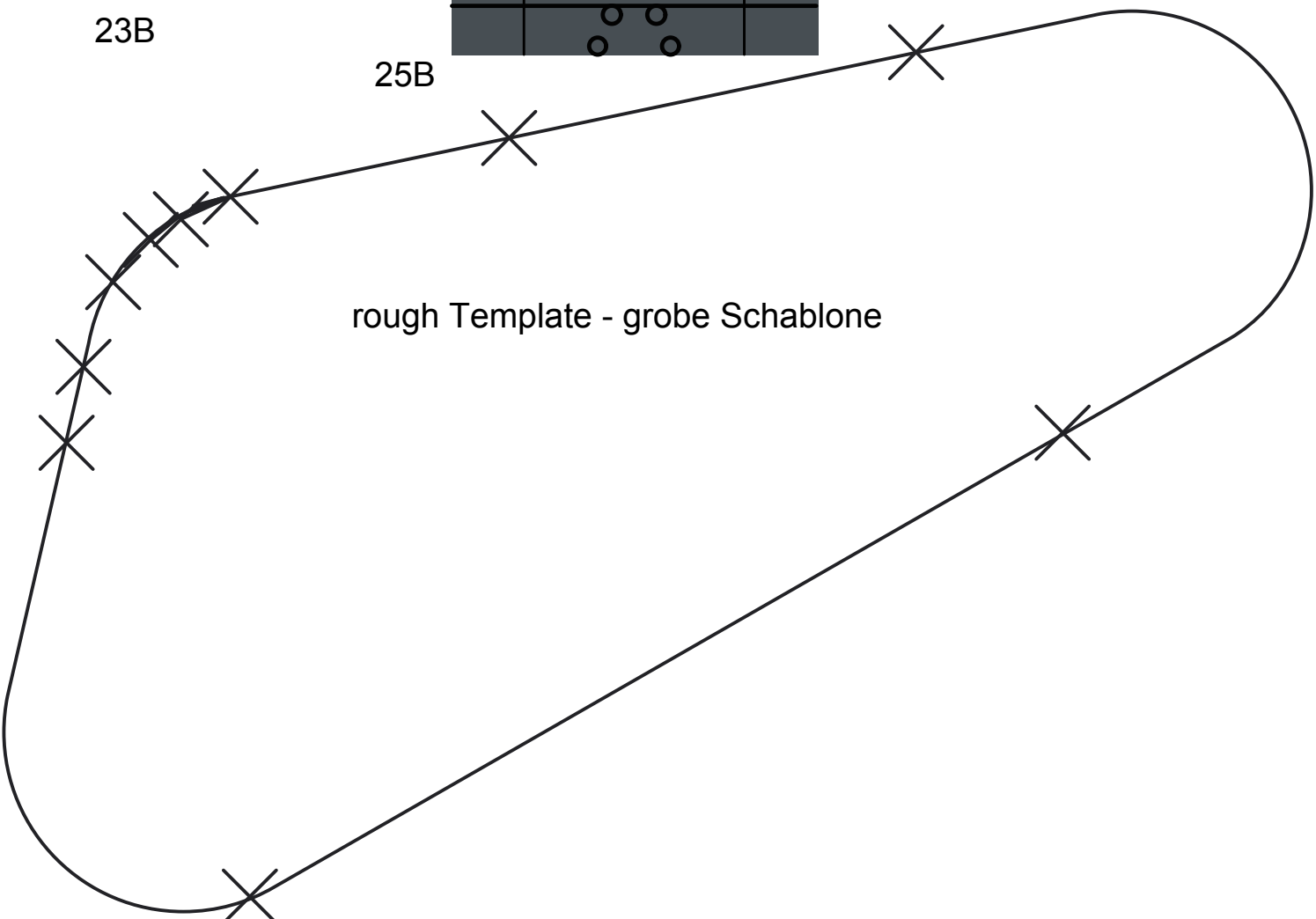

rough Template - grobe Schablone

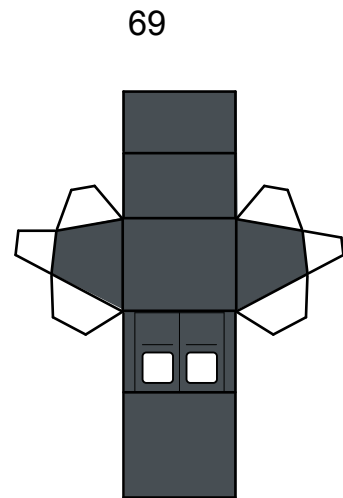
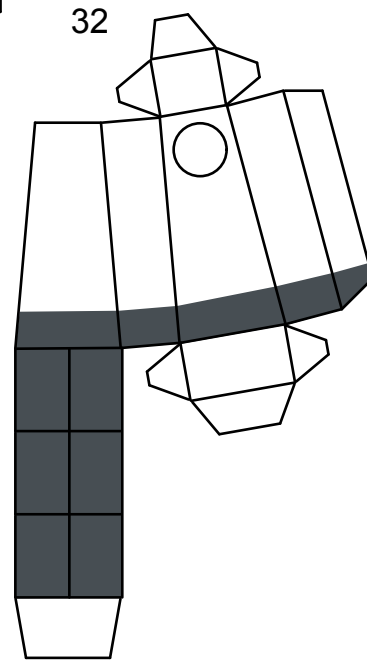
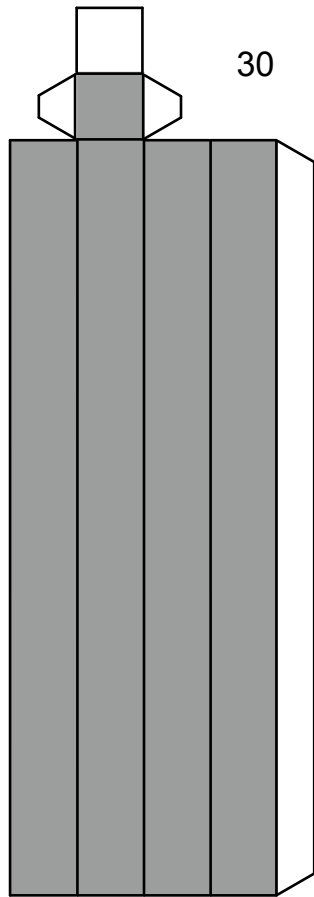
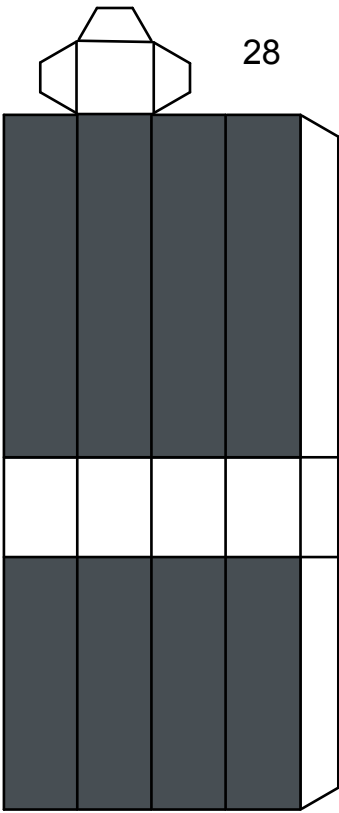
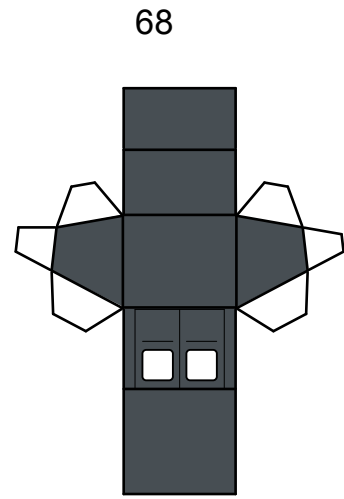
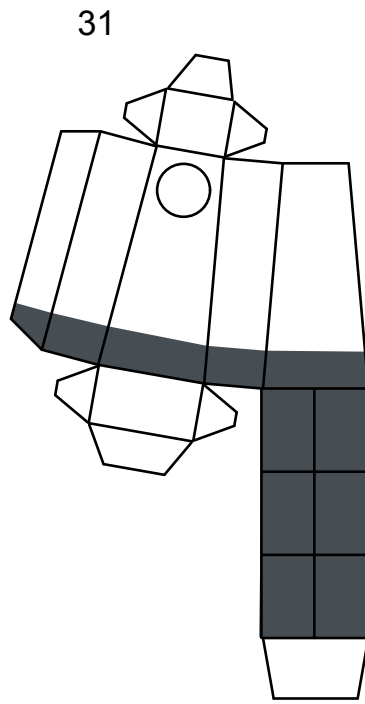
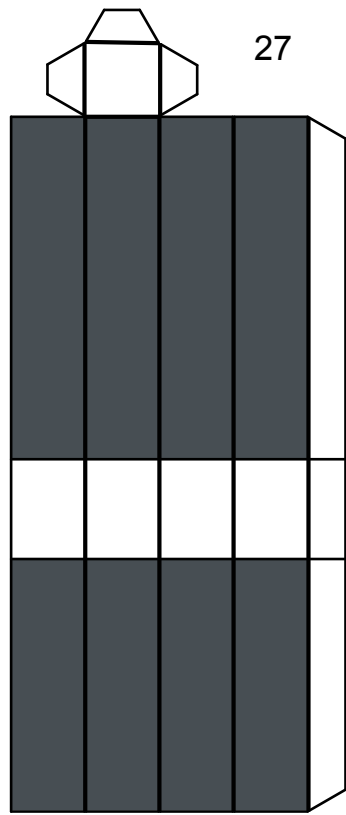
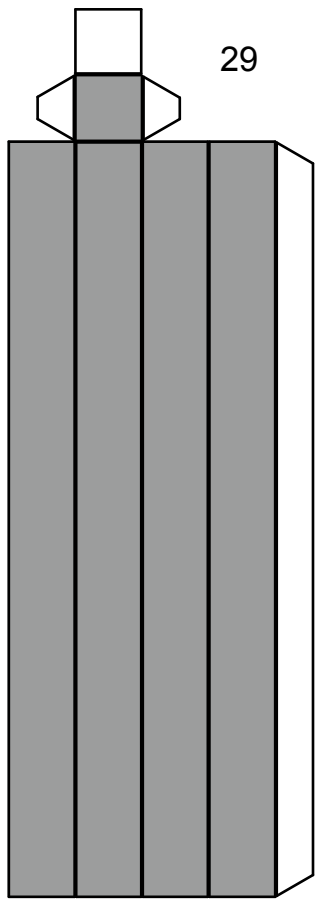

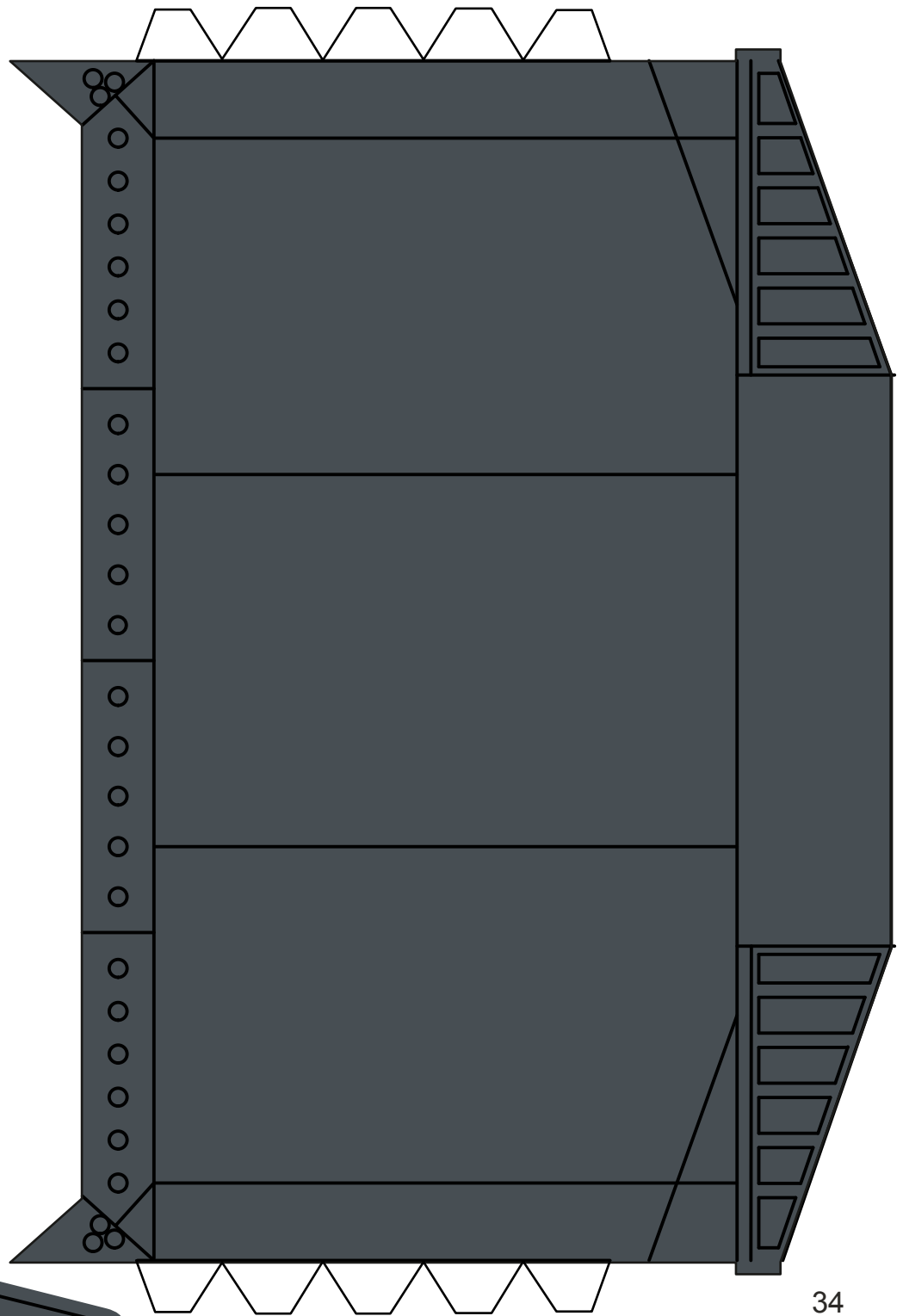

34

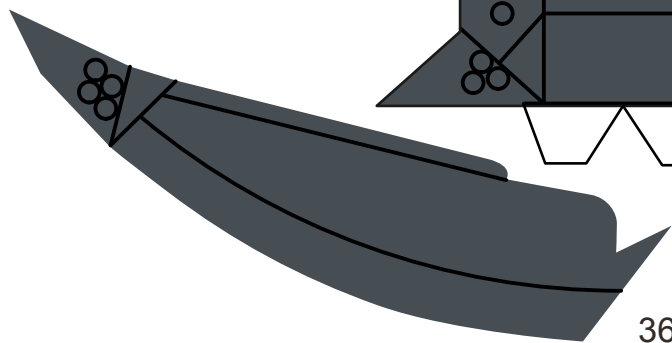

36

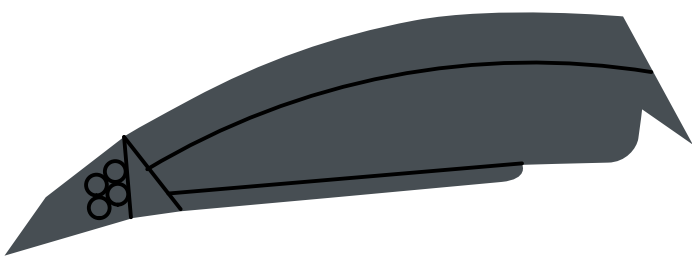

37

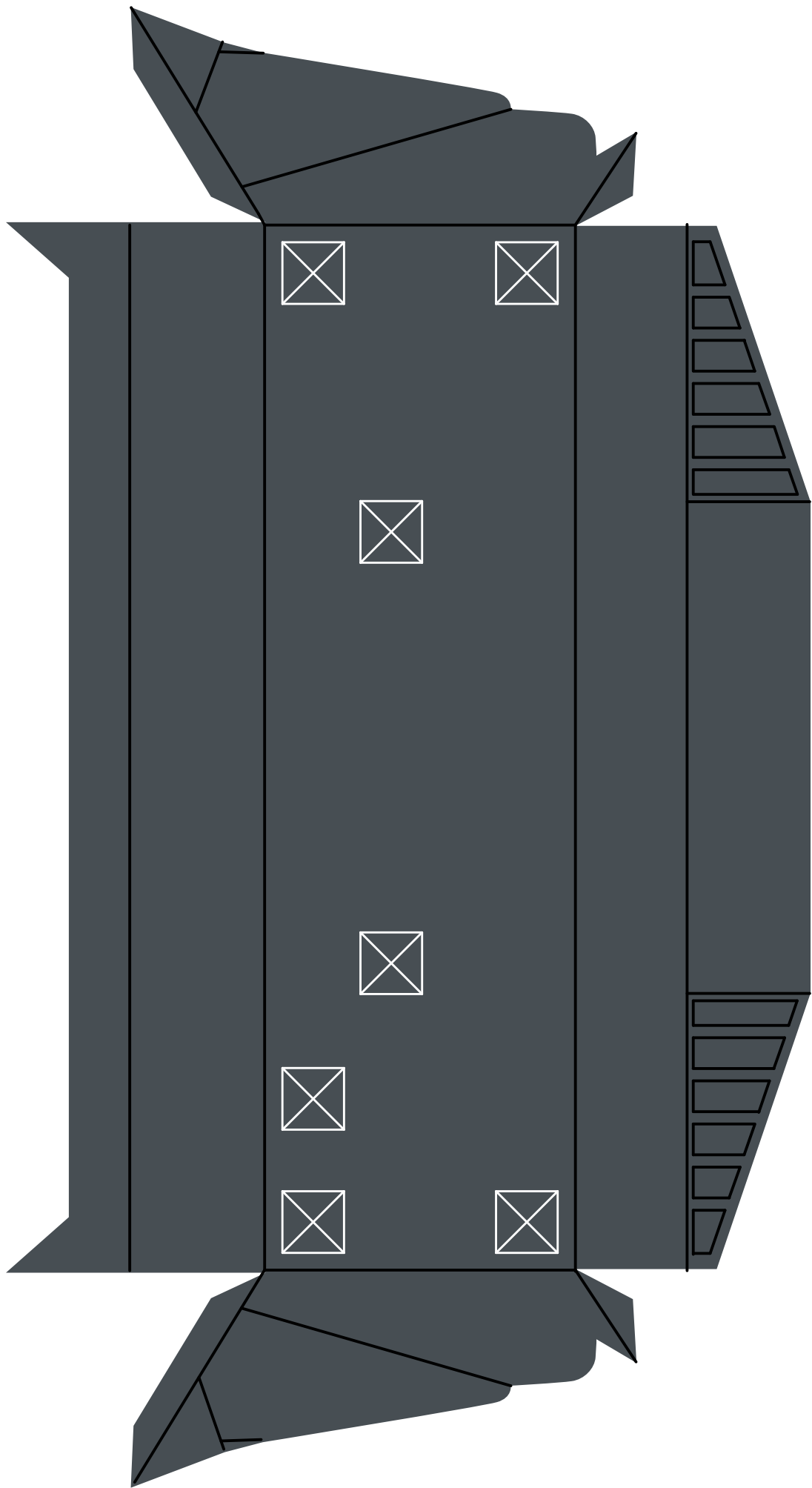



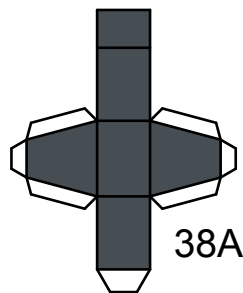
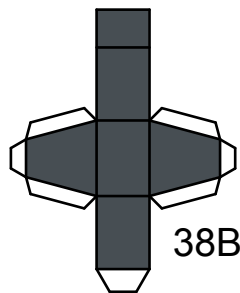
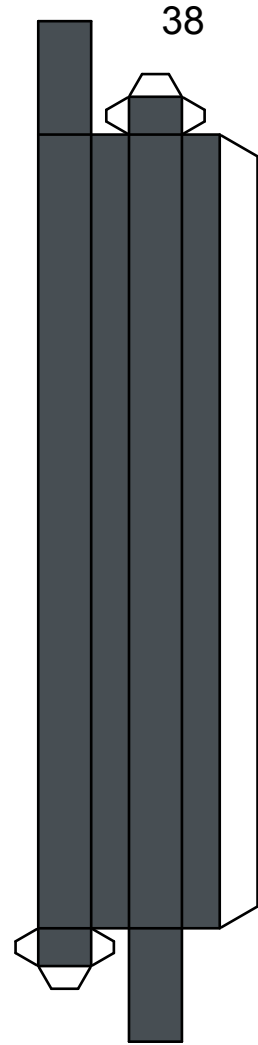
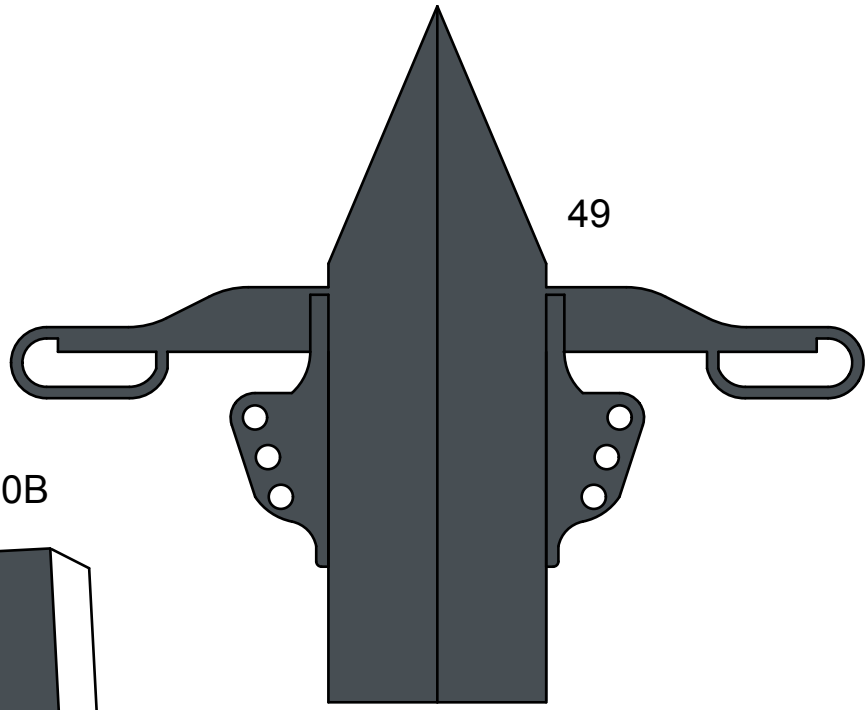
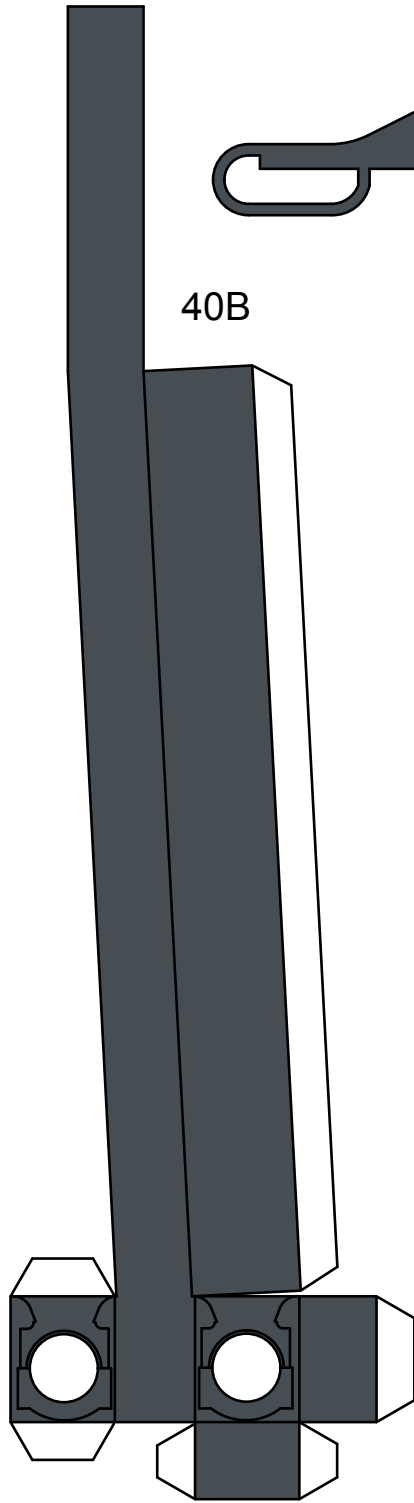
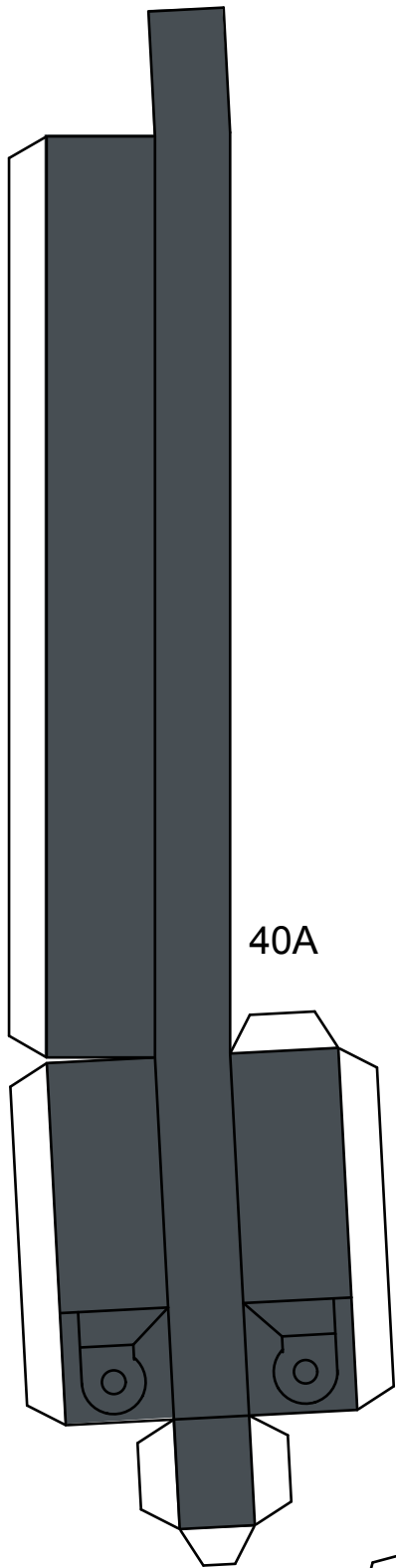

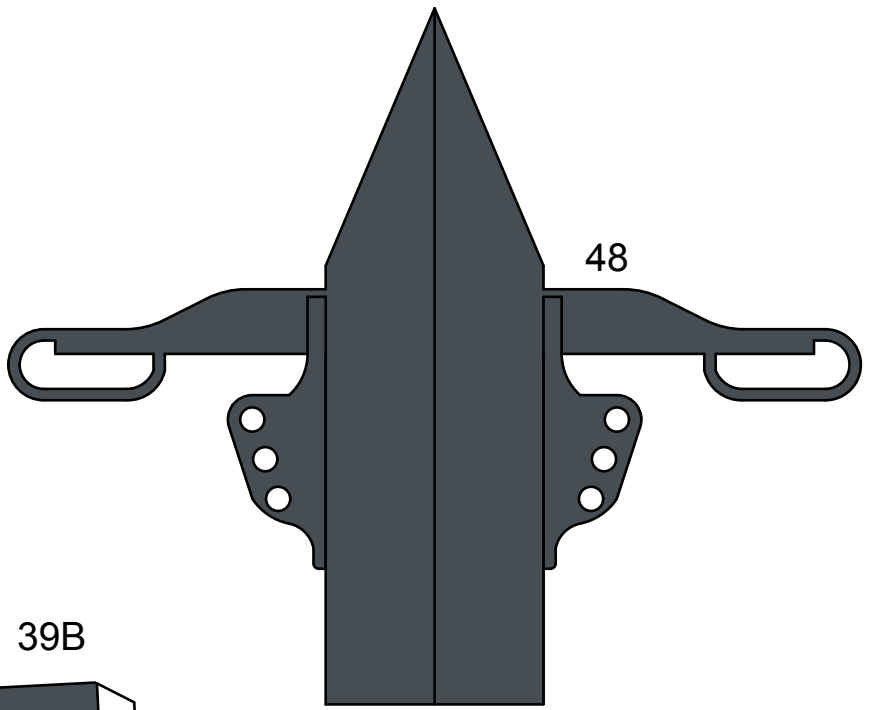
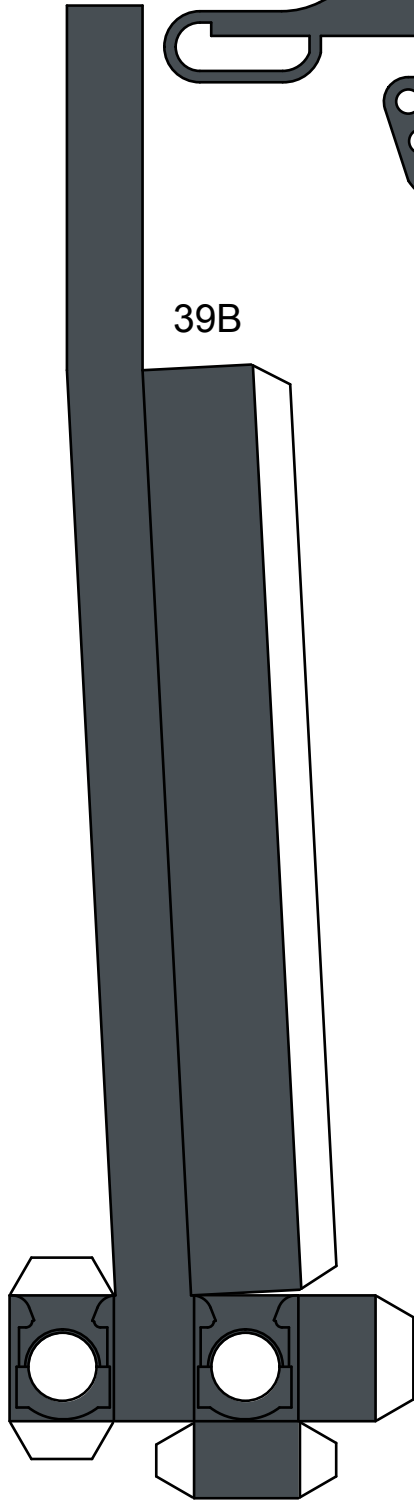

45

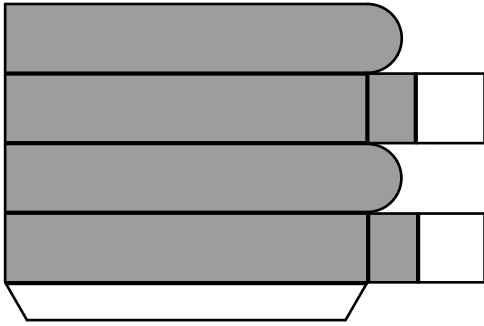

43

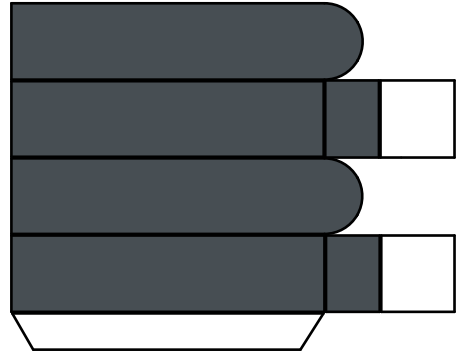

46

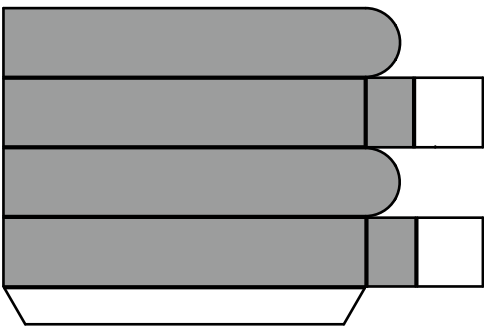

44

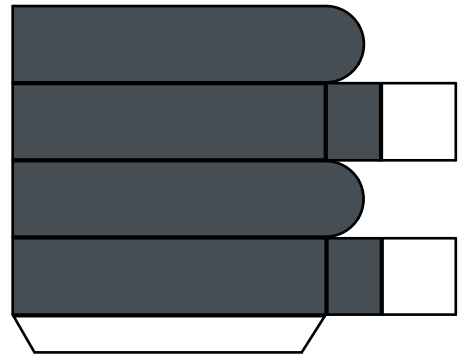

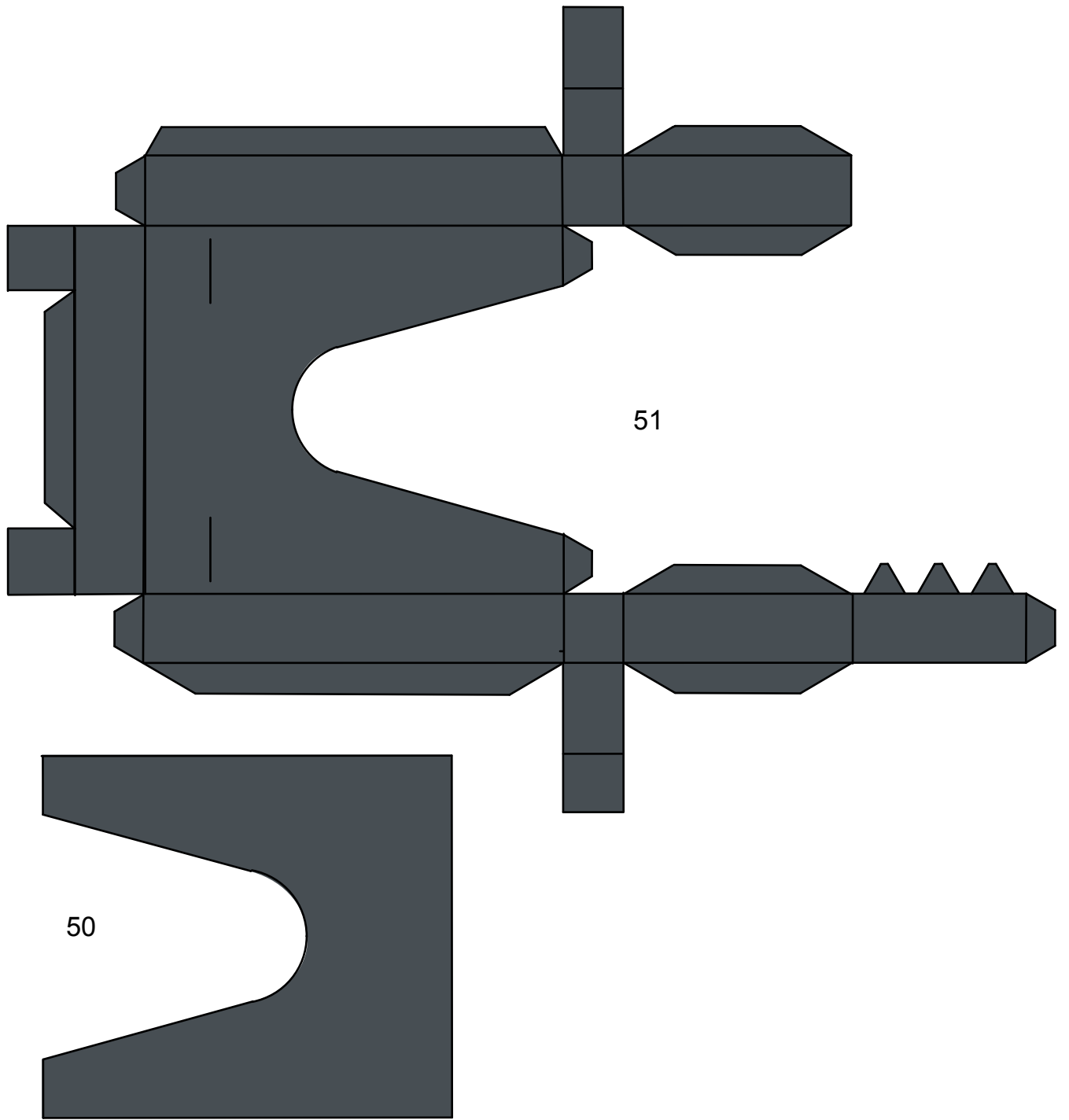

50

51

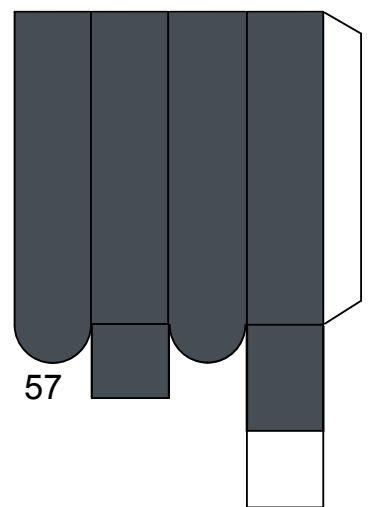
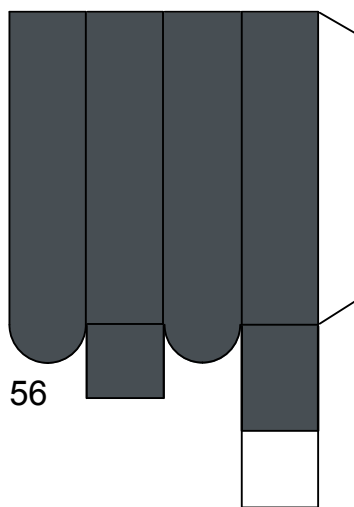
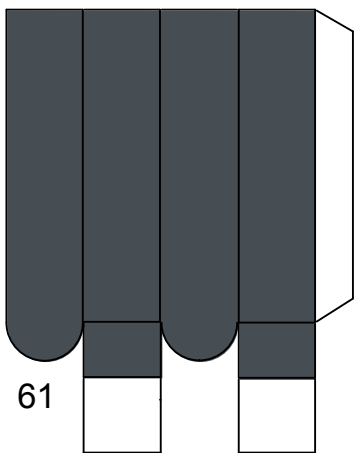
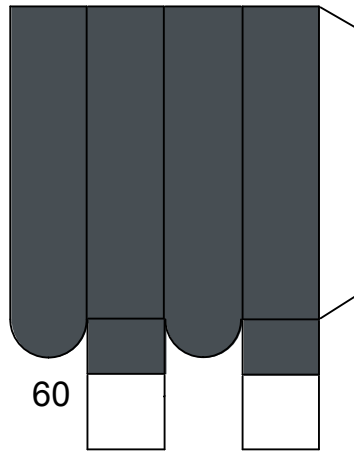
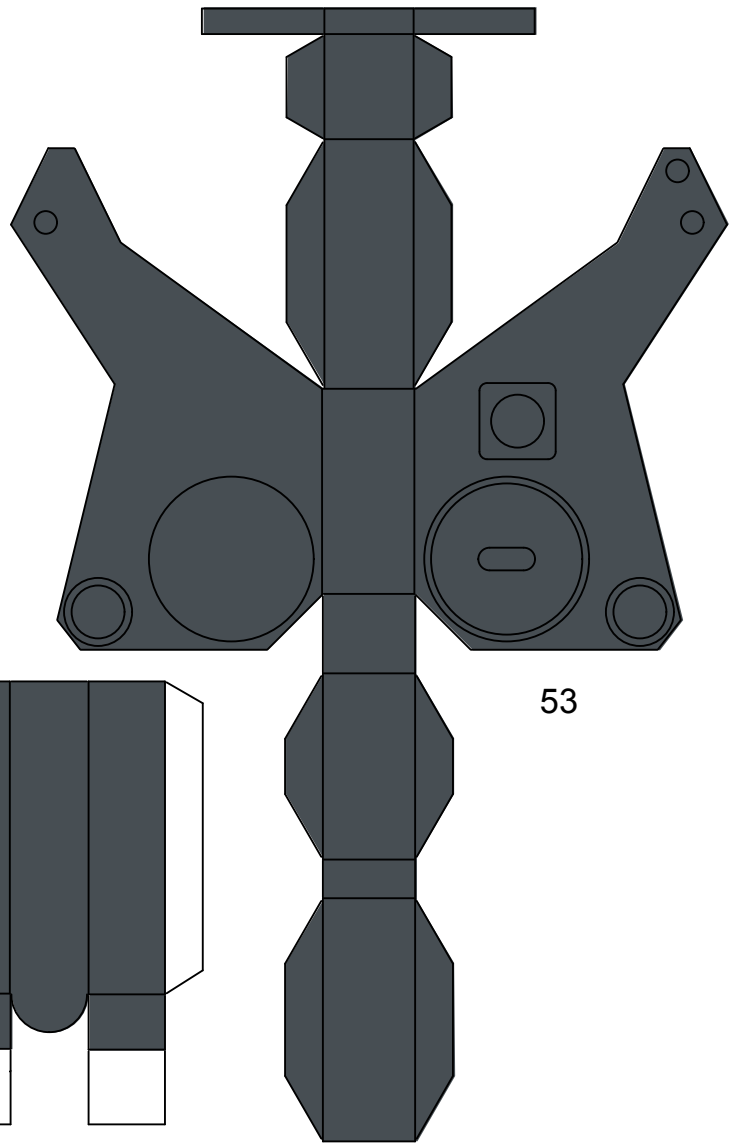
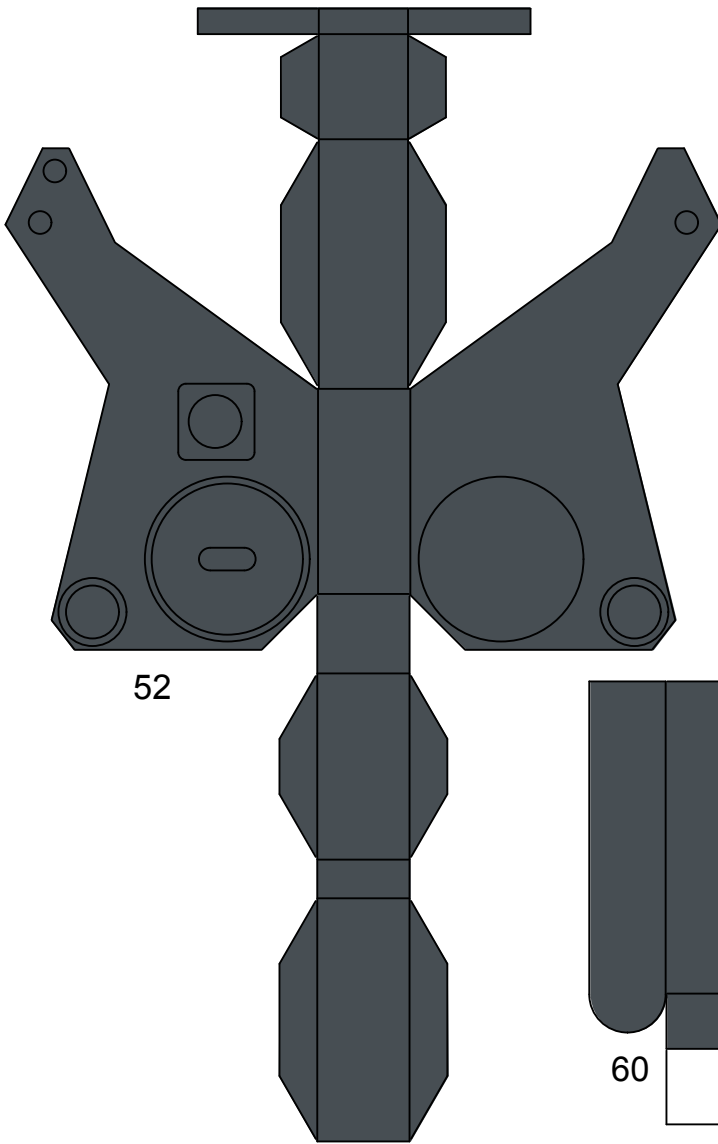

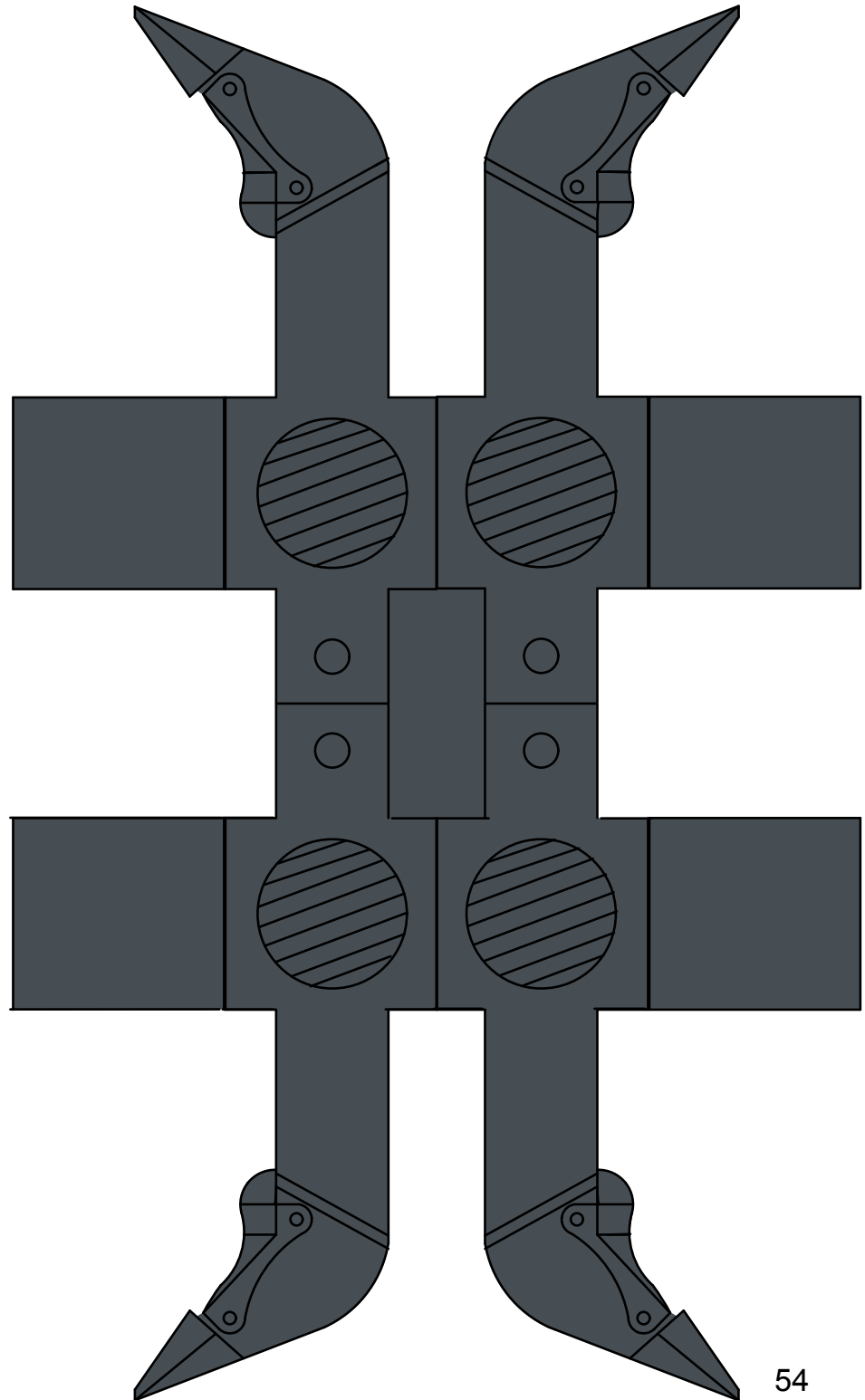
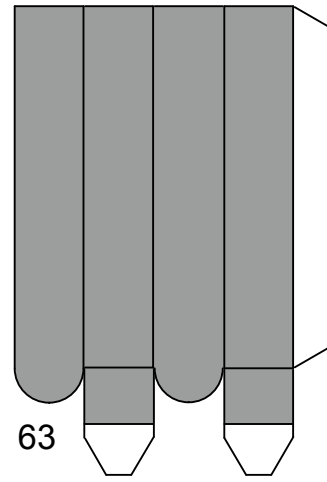
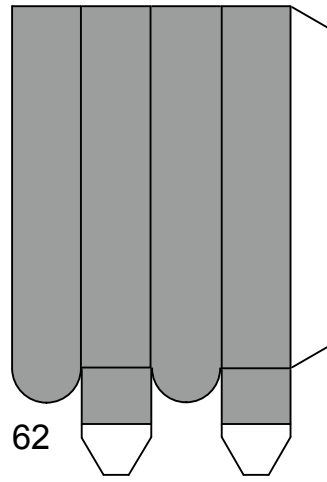
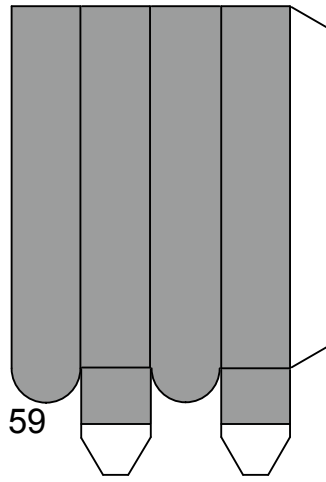
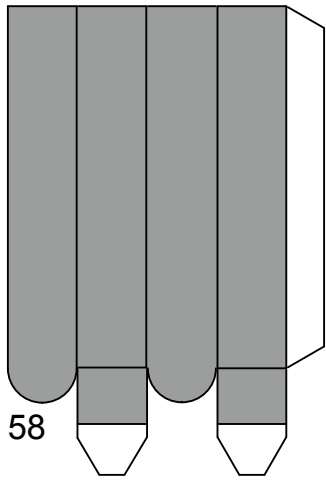

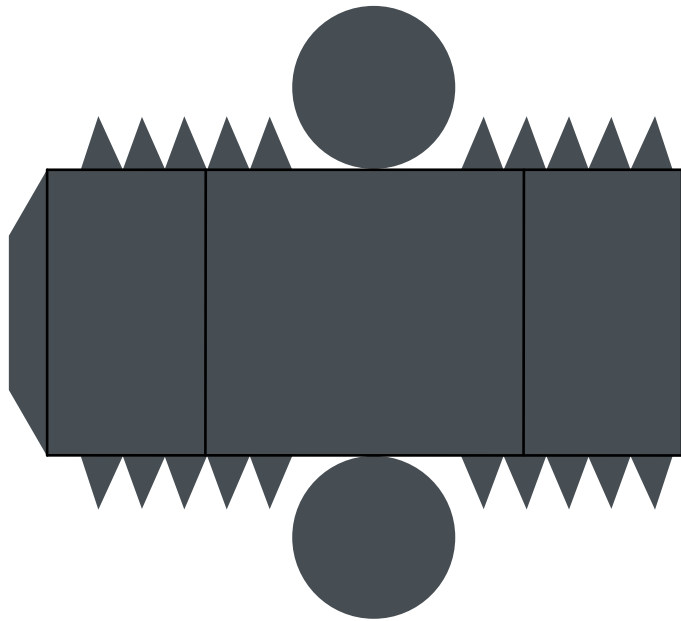
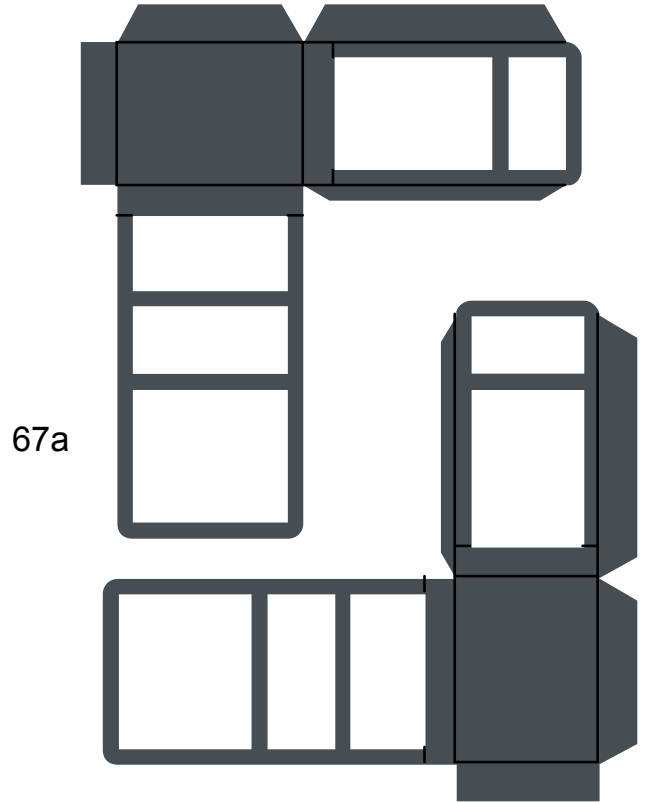
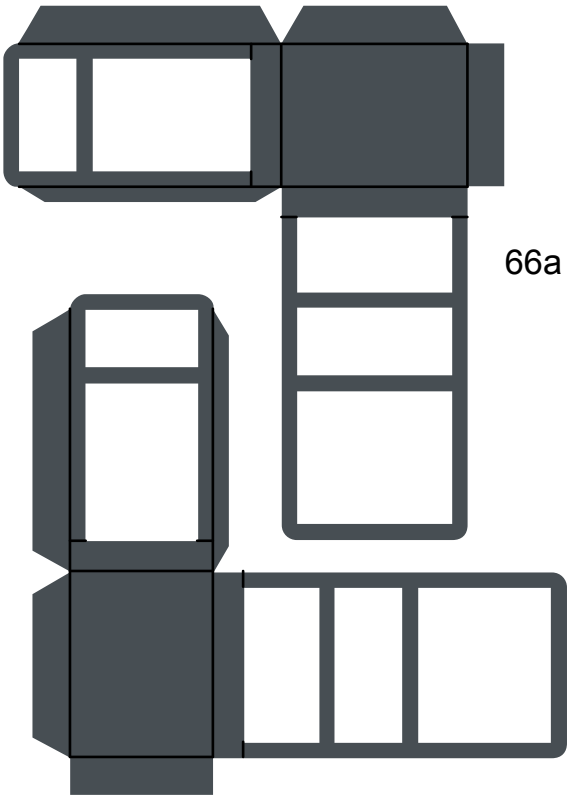

64a

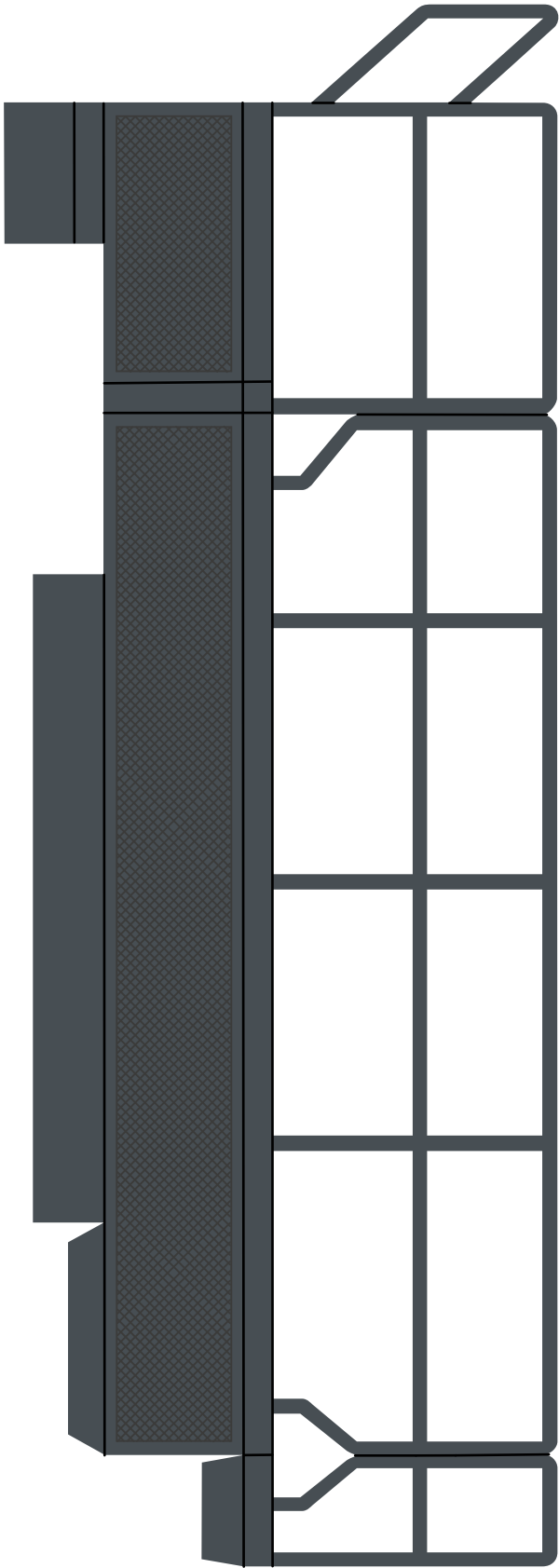

65a

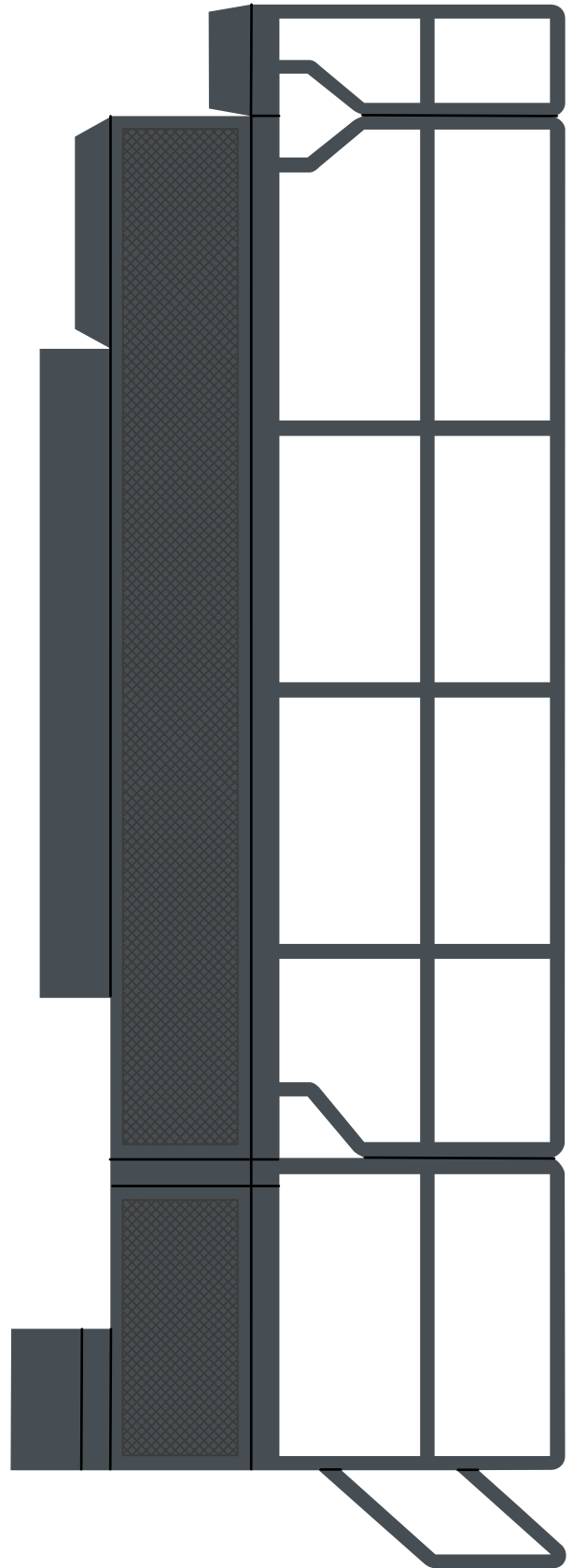



65

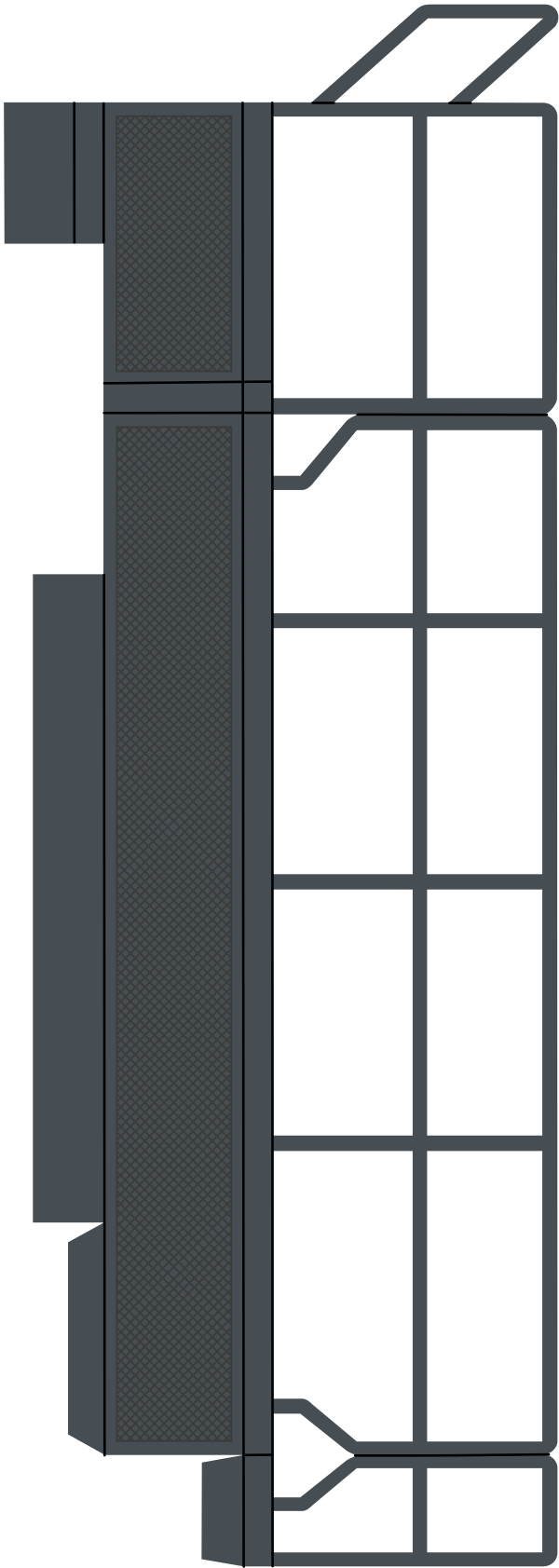

64

