

Technical Data Hydraulic crawler crane

HS 873 HD

Litronic®

Basic machine with undercarriage

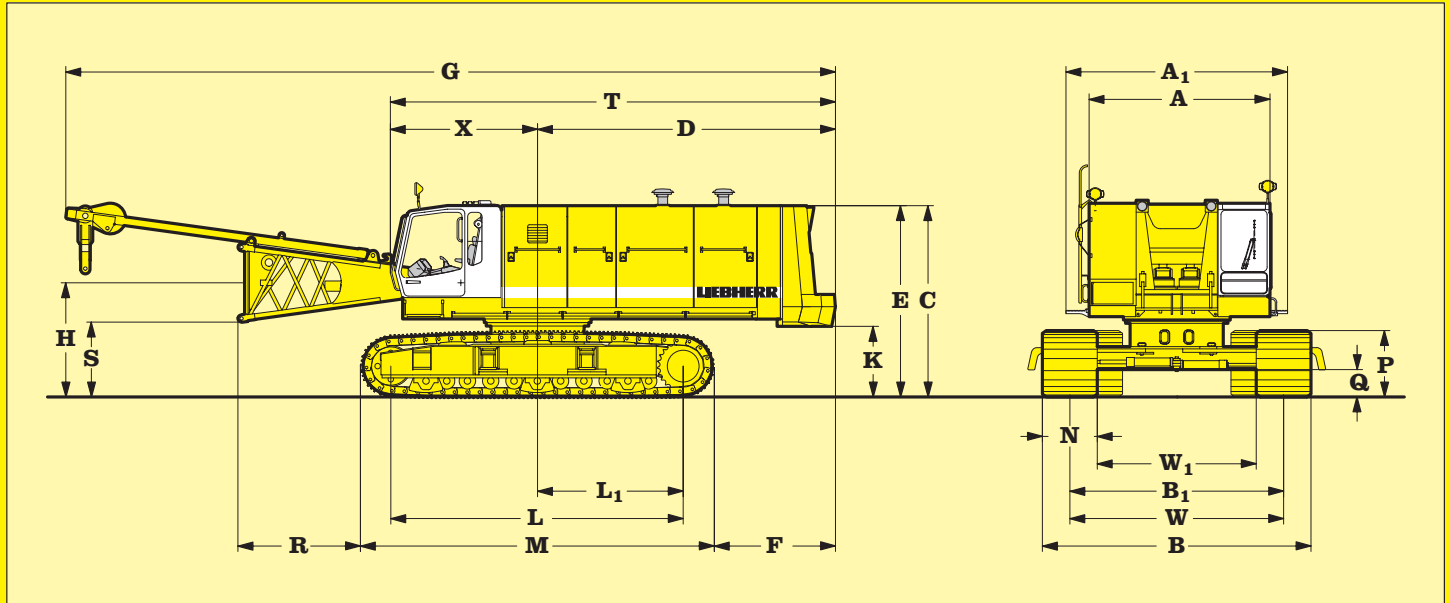

Dimensions

A	Width of superstructure	10' 10" / 11' 5"	N	Width of track shoes	2' 4" 2' 7" 2' 11" 3' 3"
A ₁	Width of superstructure with walk way	13' 3"	W	Track width retracted	12' 9" 12' 9" 12' 9" 12' 9"
C	Height of basic machine	11' 9"	W ₁	Track width extended	9' 9" 9' 9" 9' 9" 9' 9"
D	Tail reach	17' 11"	B	Crawler width extended	15' 1" 15' 5" 15' 9" 16' 1"
	Teil swing radius	18' 1"	B ₁	Crawler width retracted	12' 1" 12' 5" 12' 9" 13' 1"
E	Tail reach A-frame	11' 6"			
F	Distance between rear end of crawler and outside of counterweight	7' 4"	Operating Weight and Ground Pressure		
G	Overall length of superstructure with lowered A-frame	49' 11"	The operating weight includes the basic unit with B8 crawler tracks, 2 main winches 55,100 lbs with speed change gear and 36' (11m) boom, consisting of A-frame, 13' (4m) boom foot, 21' (6.5m) boom head section, 2' (0.6 m) boom head and 43,200 lbs counterweight + 9,900 lbs add. counterweight.		
H	Center of boom foot to ground	6' 10"	28"	flat track shoe	205,700 lbs- 17.9 lbs/sq in
K	Ground clearance of superstructure	4' 0"	31"	flat track shoe	207,900 lbs- 15.8 lbs/sq in
L	Wheel base (center' idler to center' tumbler)	17' 5"	35"	flat track shoe	210,100 lbs- 14.2 lbs/sq in
L ₁	Distance from center' of rotation to center' of tumbler	8' 8"	39"	flat track shoe	212,500 lbs- 12.9 lbs/sq in
M	Length of crawlers	21' 2"	28"	triple grouser track shoe	201,700 lbs- 17.5 lbs/sq in
P	Height of crawler	3' 11"	31"	triple grouser track shoe	203,500 lbs- 15.5 lbs/sq in
Q	Ground clearance of crawler	1' 8"	35"	triple grouser track shoe	205,250 lbs- 13.8 lbs/sq in
R	Distance from edge of horizontal boom foot to crawler	7' 4"	39"	triple grouser track shoe	207,000 lbs- 12.5 lbs/sq in
S	Ground clearance of horizontal boom foot	4' 6"			
T	Length of superstructure	26' 9"			
X	Distance from center' of rotation to end of cab	8' 10"			

LEIBHERR

The Better Machine.

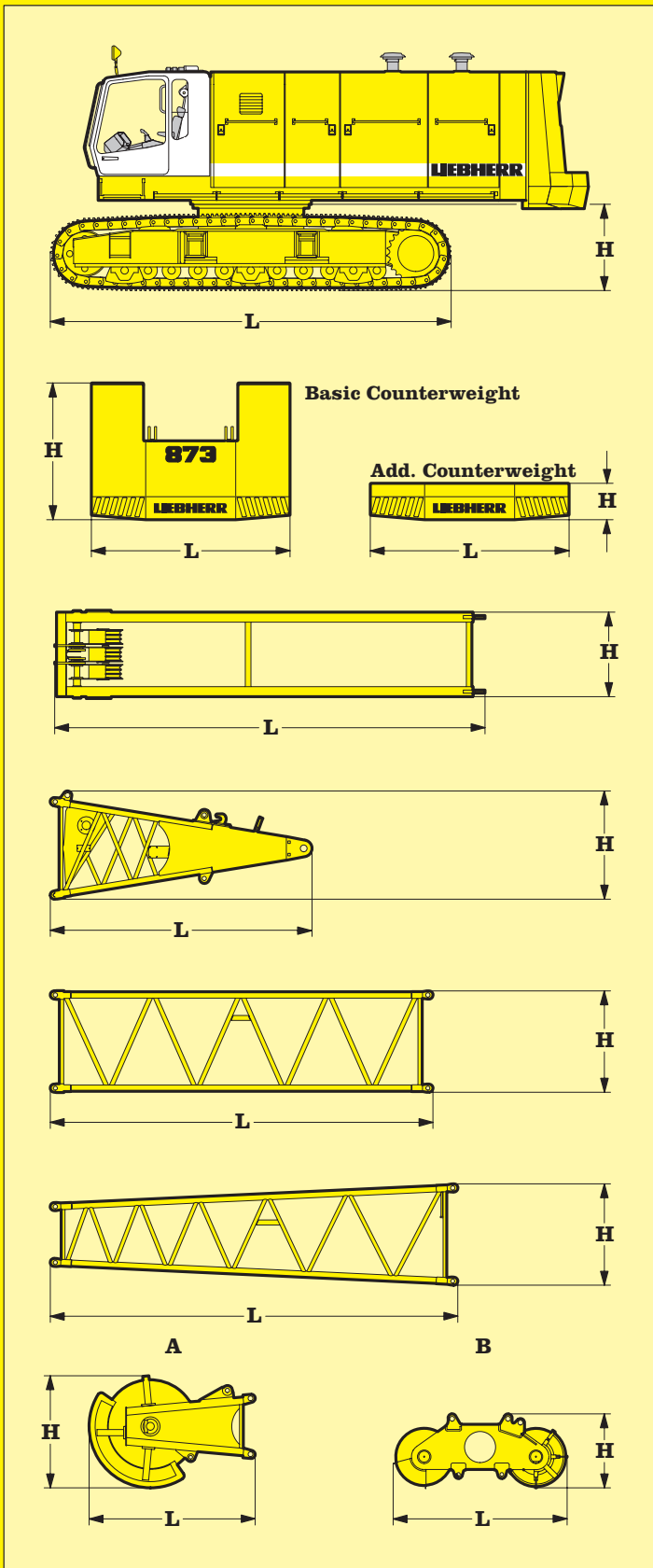

Basic machine

with HD undercarriage, 43,200 lbs counterweight, V 8 cylinder Liebherr diesel engine, 2 x 55,100 lbs (2x25t) winches with gear box.
Triple grouser track shoe 28" 31" 35" 39"

Weight in lbs	187,200	188,900	190,900	192,500
---------------	---------	---------	---------	---------

Crawler retraced

Triple grouser track shoe	28"	31"	35"	39"
---------------------------	-----	-----	-----	-----

L Length	21' 2"	21' 2"	21' 2"	21' 2"
H Height	4' 6"	4' 6"	4' 6"	4' 6"
Width	12' 1"	12' 5"	12' 9"	13' 1"
Weight in lbs	68,900	70,600	72,400	74,200

Counterweight

	Basic	Additional
L Length	10' 6"	10' 6"
H Height	7' 3"	1' 11"
Width	2' 4"	2' 3"
Weight in lbs	42,300	9,900

A-frame

	short	long
L Length	18' 10"	22' 9"
H Height	4' 9"	4' 9"
Width	3' 7"	4' 7"
Weight in lbs	3,700	4,100

Boom foot

	Basic	Dragline
L Length	13' 9"	13' 9"
H Height	5' 1"	5' 1"
Width	4' 9"	4' 9"
Weight in lbs	4,200	4,500

Tubular boom extension

	10'	20'	30'
L Length	10' 5"	20' 3"	30' 1"
H Height	4' 9"	4' 9"	4' 9"
Width	4' 9"	4' 9"	4' 9"
Weight in lbs	1,500	2,300	2,900

Boom head section

L Length	21' 5"
H Height	4' 9"
Width	4' 10"
Weight in lbs	2,400

Boom head

	A	B
L Length	8' 9"	9' 3"
H Height	5' 11"	3' 10"
Width	2' 7"	3' 6"
Weight in lbs	3,700	3,800

Transport dimensions and weights



Engine

Water cooled, V 8 cylinder Liebherr diesel engine, turbo charged with intercooler, model D 9408 Ti, power rating according to DIN ISO 3046 T1 IFN: 448 hp (330 kW) at 1800 rpm.

Option:

Water cooled, V12 cylinder Mercedes Benz diesel engine, turbo charged with intercooler, type OM 444 LA, power rating according to DIN ISO 3046 T1 IFN: 609 hp (448 kW) at 1900 rpm.

The automatic limiting load control adapts perfectly the power of the main users to the present engine speed.

The temperature and engine speed controlled cooling system saves energy and reduces the noise emission.

Fuel Tank: 243 gal capacity with continuous level indicator and reserve warning.



Hydraulic System

The main pumps are operated by a distributor gearbox. Axial piston displacement pumps work in closed and open circuits supplying oil only when needed (flow control on demand). To minimize peak pressure a automatically working pressure cut off is integrated. This lowers pump wear.

Winch 1 and 2: Axial piston displacement pumps (swash plate design) with 132 gal/min. each.

Crawlers: Axial piston displacement pumps (swash plate design) with 2 x 105 gal/min.

Swing gear: Axial piston displacement pump (swash plate design) with 75 gal/min.

Boom hoist: Axial piston displacement pump (swash plate design) with 53 gal/min.

Max. working pressure: 5075 psi.

Hydraulic oil tank capacity: 290 gal

The cleaning of the hydraulic oil is made through electronically controlled pressure and return filters.

Contamination is signaled in the cabin.

Ready made hydraulic retrofit kits are available to customize requirements e. g. powering casing oscillators, auger drills etc.



Winches

Winch options:

Line pull in lbs	35,300	44,100	55,100
Rope diameter :	1 ¹ / ₃₂ "	1 ³ / ₁₆ "	1 ¹¹ / ₃₂ "
Drum diameter :	21.7"	24.8"	29.5"
Rope speed ft/min	0-348	0-279	0-226
With change gear box			0-505
Rope capacity			

1st layer 153 ft 153 ft 158 ft
The winches stand out for their compact design and easy assembly.

Winch drive via a planetary gearbox in oil bath. Load support by the hydraulic system; additional safety factor provided by a spring loaded, multi disc holding brake.

Clutch and braking functions on the free - fall system are provided by a compact designed, low wear and maintenance free multi disc brake. The dragline and hoist winches use pressure controlled, variable flow hydraulic motors. This system features sensors that automatically adjust oil flow to provide max. winch speed depending on load.

Working with 2 rope clamshell, the oil motors distribute the load to both winches providing speed compensation, even when working in different rope layers.

Option:

Crane winch 35300 lbs (16 t) - without clutch, but with multi disc holding brake.



Noise emission

Special sound proofing results in a very low noise level of 78 dB(A) at 52 ft (16 m) radius.



Equipment

Lattice boom of tubular construction up to 166 ft (50 m), universal boom head with interchangeable rope pulleys.

Modular designed equipment for operation as crane, dragline or clamshell.

For dragline operation, a rotating fairlead is fitted into the boom foot, which minimizes rope angle to drum, which results in lower rope wear.



Swing Drive

Consists of single row ballbearing swing ring with external teeth for lower tooth flank pressure, fixed axial piston hydraulic motor, spring loaded and hydraulically released multi-disc holding brake, planetary gearbox and pinion.

Free swing with hydraulic moment control reduces wear to a minimum, because rotation moment is sustained through the hydraulic system by the diesel engine.

Swing speed from 0 - 3.7 rpm continuously variable.



Crawler

The track width of the undercarriage is changed hydraulically. Crawler drive through axial piston motor. Hydraulically released spring loaded multi-disc brake, maintenance free crawler tracks, hydraulic chain tensioning device.

Flat or triple grouser track shoe. Drive speed 0 - 1 mph.

Option:

2 speed hydraulic motor for higher travel speed.



Control

The control system - developed and manufactured by Liebherr - is designed to withstand temperature extremes and the many heavy-duty construction tasks for which this crane has been designed. Complete machine operating data are displayed on a high resolution monitor screen.

To ensure clarity of the information on display, different levels of data are shown in enlarged lettering and symbols. Control and monitoring of the sensors are also handled by this high technology system. Error indications are automatically displayed on the monitor.

The crane is equipped with proportional control for all movements, which can be carried out simultaneously.

A special "Interlock" control system is also optionally available. It is designed for power lifting of the dragline bucket without using the grab winch brake.

An additional option is also the so-called "Redundant" control system, which allows restricted operation of the machine in the event of a failure on the electronic base control or its sensors.

On request, Liebherr also offers special custom designed control systems for free fall winches.

The operation of the crane is done with 2 multi-directional joysticks, right for winch I and boom hoist drive, left for winch II and slewing gear.

- Options:
- Both main winches with double-T levers
 - Special demolition control system
 - MDE: Machine data recording
 - PDE: Process data recording



Boom hoist drive

Two drum design internally located planetary gearbox, axial piston hydraulic motor and hydraulically released spring loaded multi-disc brake.

Max. line pull 2 x 15,400 lbs. Rope diameter: 5¹/₆₄"

Max. line speed: 75 ft/min.

Two speed boom hoist option

Technical Description

43,200 lbs basic + 9,900 lbs add. counterweight

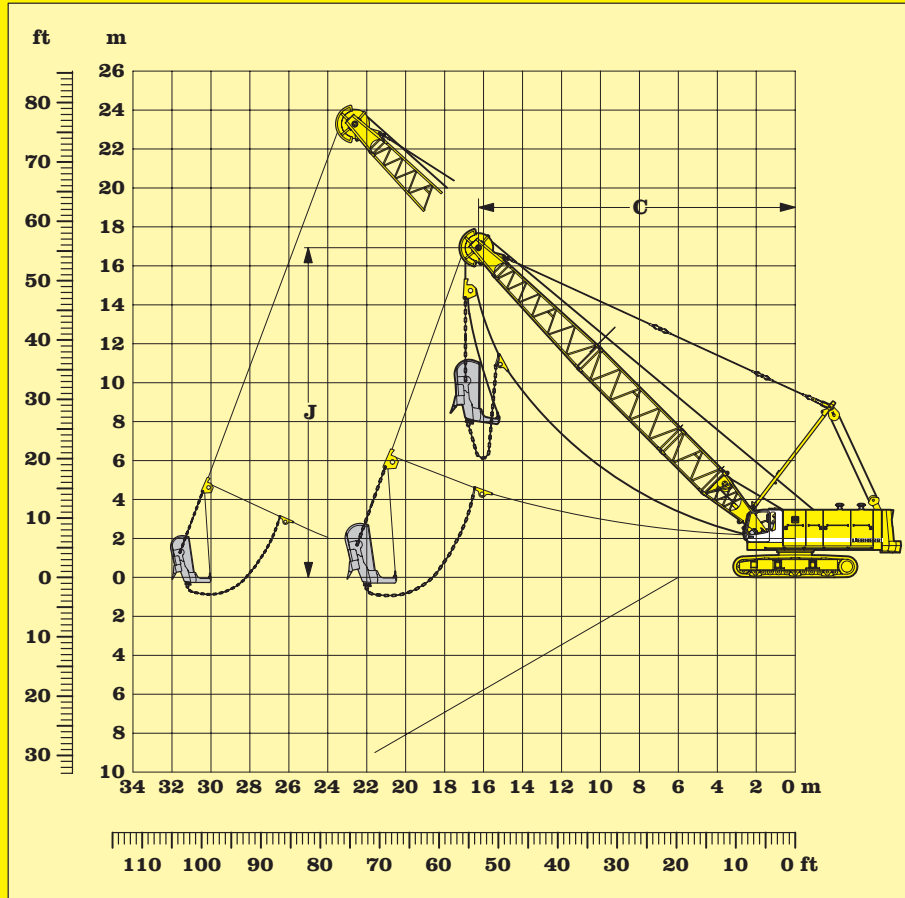

The following equipment is required:

- Basic machine with corresponding track shoes
- Add. counterweight 9900 lbs (4.5t)
- Second swing drive with free swing
- A-frame
- Boom foot 13 ft (4 m)
- Boom extension 10 ft (3 m) tubular steel
- Boom extension 20 ft (6 m) tubular steel
- Boom extension 30 ft (9 m) tubular steel
- Boom head section 21 ft (6.4 m)
- Boom head with interchangeable pulleys
- Stay ropes according to boom length
- Main winches according to specification
- Drag rope should be $\frac{5}{64}$ " below nominal diameter
- Corresponding fair lead
- Corresponding ropes optional
- Dragline bucket optional

Capacities in 1000 lbs for boom lengths from 49ft (15m) to 99ft (30m)													Counterweight 53,100 lbs					
Boom angle	49ft (15m)			59ft (18m)			69ft (21m)			79ft (24m)			89ft (27m)			99ft (30m)		
	C	J	lbs	C	J	lbs	C	J	lbs	C	J	lbs	C	J	lbs	C	J	lbs
45	41.4	41.8	44.9	48.3	48.7	35.9	55.5	55.5	28.8	62.4	62.4	24.7	69.3	69.7	20.9	76.1	76.5	17.8
40	44.3	38.5	41.2	52.0	44.7	32.1	59.6	51.2	26.4	67.0	57.9	22.5	74.6	63.8	18.9	82.0	70.0	15.8
35	47.0	35.1	38.1	55.1	40.8	29.3	63.0	46.3	24.7	71.2	52.0	20.7	79.1	57.5	17.1	87.3	63.4	14.3
30	49.2	31.6	35.2	57.9	36.5	27.3	66.3	41.4	22.5	74.9	46.3	18.7	83.4	51.2	15.4	92.0	56.1	12.8
25	51.2	27.7	33.0	60.0	31.9	26.0	69.0	35.9	20.3	78.1	40.0	16.7	87.0	44.3	13.9	95.9	48.3	11.5
Content of dragline bucket																		
cu.yd.	4			3 $\frac{1}{2}$			3 $\frac{1}{4}$			3			2 $\frac{1}{2}$			2		
m ³	3.0			2.7			2.5			2.3			1.9			1.5		

Max. capacities do not exceed 75 % of tipping load

Optimal boom configuration for boom lengths between 36ft (11m) to 166ft (50m):																
	Length	Amount of boom extensions														
		Boom foot	13ft (4.0m)	1	1	1	1	1	1	1	1	1	1	1	1	1
Boom extension	10ft (3.0m)		1					1					1			1
Boom extension	20ft (6.0m)				1					1				1		
Boom extension	30ft (9.0m)					1	1	1	1	2	2	2	3	3	3	4
Boom head extension	21ft (6.4m)	1	1	1	1	1	1	1	1	1	1	1	1	1	1	1
Boom head	2ft (0.6m)	1	1	1	1	1	1	1	1	1	1	1	1	1	1	1
Boom length in (ft)		36	46	56	66	76	86	96	106	116	126	136	146	156	166	

Dragline equipment

43,200 lbs basic + 9,900 add. counterweight

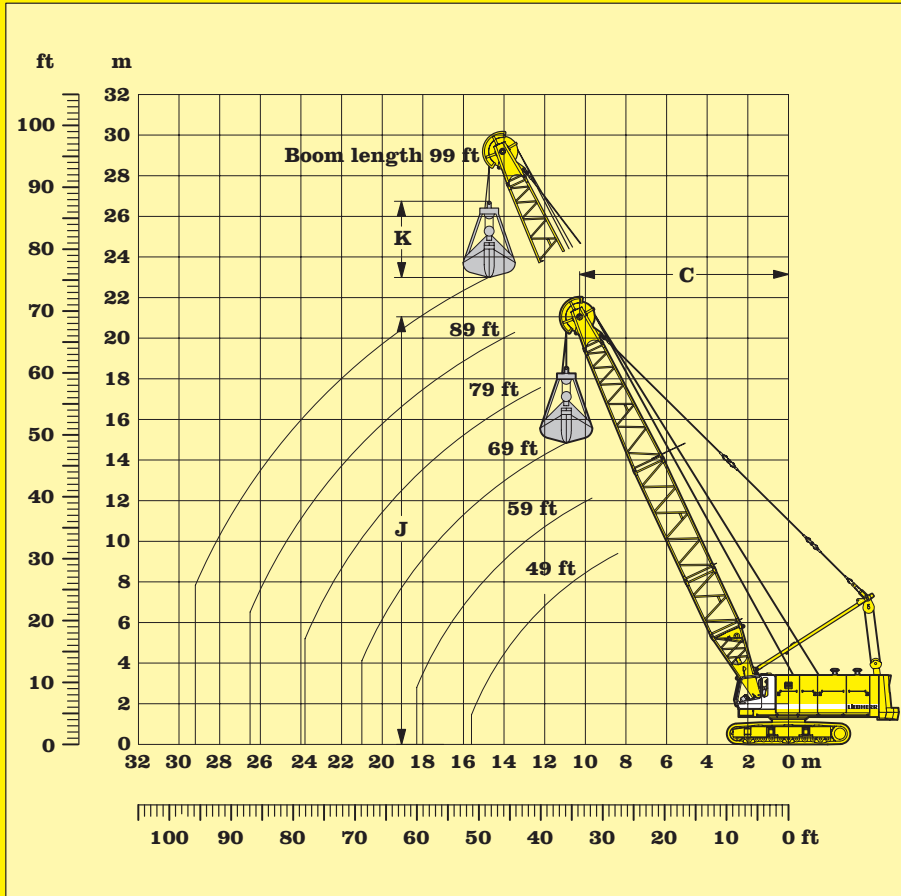

The following equipment is required:

- Basic machine with corresponding track shoes
- Add. counterweight 9900 lbd (4.5 t)
- A-frame
- Boom foot 13ft (4m)
- Boom extension 10ft (3m) tubular steel
- Boom extension 20ft (6m) tubular steel
- Boom extension 30ft (9m) tubular steel
- Boom head section 21ft (6.4m)
- Boom head with interchangeable pulleys
- Stay ropes according to boom length
- Main winches according to specification
- Tagline winch
- Corresponding ropes optional
- Clamshell optional
- Hoist limit switch
- Load moment limitation
- 4-rope clamshell on request

Working diagram

C = Radius / dumping radius

J = Height of boom head sheave centre above ground level

K = Length of clamshell (depending on type and capacity of bucket)

Capacities in 1000 lbs for boom lengths from 49 ft (15m) to 99 ft (30m):											Counterweight 53,100 lbs							
Boom angle	49ft (15m)			59ft (18m)			69ft (21m)			79ft (24m)			89ft (27m)			99ft (30m)		
	C ft	J ft	lbs	C ft	J ft	lbs	C ft	J ft	lbs	C ft	J ft	lbs	C ft	J ft	lbs	C ft	J ft	lbs
65	27.7	51.2	61.7	31.6	60.4	51.8	35.9	69.3	44.7	40.0	78.1	38.8	44.0	87.0	33.7	48.3	95.2	29.5
60	31.2	49.3	58.4	36.1	57.9	47.2	41.0	66.3	40.1	46.0	74.9	33.9	51.0	83.4	29.1	55.9	92.0	25.1
55	34.9	47.0	50.7	40.8	55.1	41.2	46.3	63.4	34.1	52.0	71.2	28.9	57.5	79.5	24.7	63.0	87.3	21.1
50	38.5	44.3	44.7	44.7	52.0	36.1	51.0	59.5	30.0	57.1	67.0	25.1	63.8	74.6	21.1	70.0	82.0	18.0
45	41.4	41.8	40.1	48.3	48.7	32.4	55.5	55.5	26.7	62.4	62.4	22.2	69.3	69.7	18.7	76.1	76.5	15.8
40	44.3	38.5	36.6	52.0	44.7	29.3	59.5	51.2	24.0	67.0	57.5	20.0	74.6	63.8	16.7	82.0	70.0	14.1
35	47.0	35.1	33.7	55.1	40.8	27.1	63.0	46.3	22.2	71.2	52.0	18.3	79.1	57.5	15.2	87.3	63.4	12.5
30	49.3	31.6	31.7	57.9	36.5	25.3	66.3	41.4	20.7	74.9	46.3	16.9	83.4	51.2	14.1	92.0	56.1	11.7
25	51.2	27.7	29.7	60.0	31.9	23.8	69.0	35.9	19.4	78.1	40.0	15.8	87.0	44.3	13.0	95.9	48.3	10.8

Max. capacities do not exceed 66.7 % of tipping load.

Load diagram restricted by safety factors of standard ropes:

Winches	35,300 lbs	44,100 lbs	55,100 lbs
Rope diameter	6 ¹ / ₆₄ "	1 ¹ / ₃₂ "	1 ¹¹ / ₃₂ "
Calc. breaking load	135,100 lbs	181,000 lbs	231,700 lbs
1-rope clamshell	24,500 lbs	32,600 lbs	41,800 lbs
2-rope clamshell	37,000 lbs	49,600 lbs	63,700 lbs

Clamshell equipment

43,200 lbs basic + 9,900 lbs add. counterweight

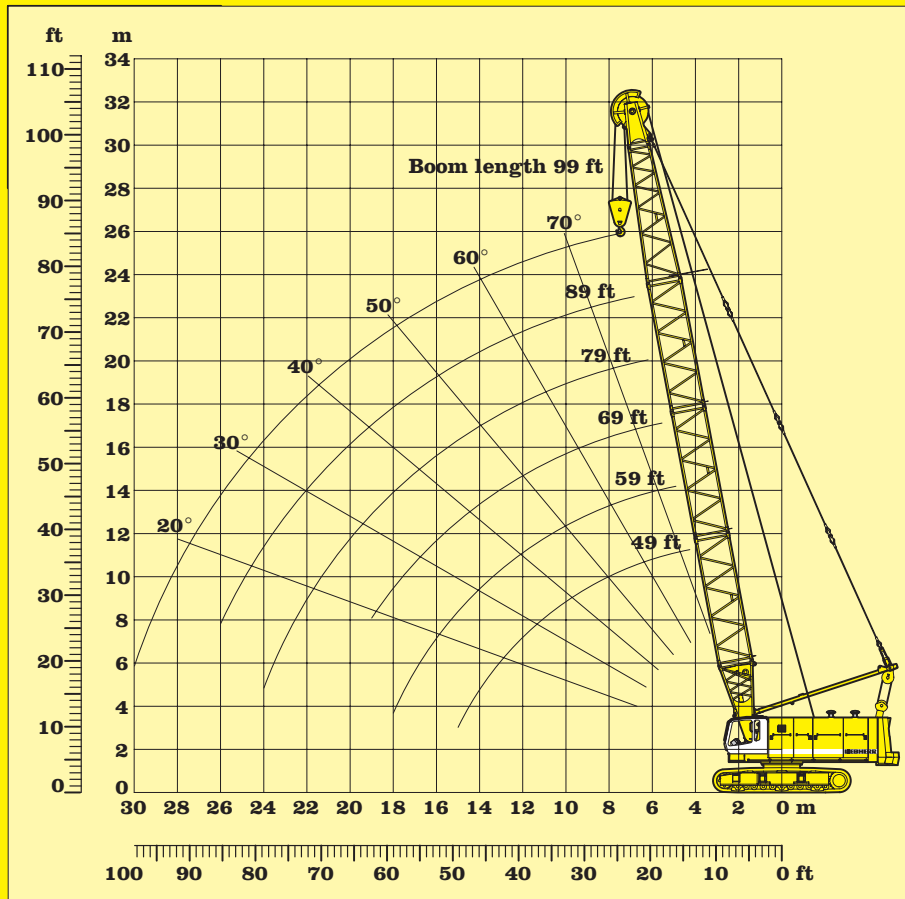

The following equipment is required:

- Basic machine with corresponding track shoes
- Add. counterweight 9900 lbs (4.5t)
- A-frame
- Boom foot 13 ft (4 m)
- Boom extension 10 ft (3 m) tubular steel
- Boom extension 20 ft (6 m) tubular steel
- Boom extension 30 ft (9 m) tubular steel
- Boom head section 21 ft (6.4 m)
- Boom head with interchangeable pulleys
- Stay ropes according to boom length
- Main winches according to specification
- Hoist limit switch
- Load moment limitation
- Corresponding ropes optional
- Corresponding hook block optional

Remarks:

1. The lifting capacities are valid for wide track.
2. The lifting capacities stated do not exceed 75% of tipping load
3. The lifting capacities are indicated in metric tons with unlimited swing (360 degrees)
4. The weight of the lifting device must be deducted to arrive at the lifting capacity.
5. Working radii are measured from centre of swing.
6. Crane standing on firm, horizontal ground.
7. Indicated values on load chart are affected by off-lead operation, wind speeds, load under slew and stop/go movements.

Capacities in 1000 lbs for boom lengths from 49ft (15m) to 99ft (30m):					Counterweight 53,100 lbs	
Boom length	49ft (15m)	59ft (18m)	69ft (21m)	79ft (24m)	89ft (27m)	99ft (30m)
Radius in ft (m)	lbs	lbs	lbs	lbs	lbs	lbs
16ft (5.0m)	89.0					
18ft (5.5m)	86.6	78.0				
20ft (6.0m)	84.4	76.3	69.0			
21ft (6.5m)	82.4	74.3	67.5	61.7		
23ft (7.0m)	80.2	72.7	66.1	60.4	52.2	
25ft (7.5m)	78.3	71.0	64.6	59.0	51.1	47.2
26ft (8.0m)	76.5	69.4	63.3	54.4	50.3	46.3
30ft (9.0m)	71.4	66.1	60.6	52.5	48.3	44.5
33ft (10.0m)	61.7	61.5	58.0	50.3	46.5	43.0
36ft (11.0m)	54.2	54.0	52.5	48.5	44.7	41.4
39ft (12.0m)	48.3	48.0	47.6	46.5	43.0	39.9
43ft (13.0m)	47.8	43.0	42.7	42.3	37.7	38.4
46ft (14.0m)	43.4	39.0	38.6	38.1	34.4	37.0
49ft (15.0m)	39.2	35.5	35.3	34.8	31.3	33.9
53ft (16.0m)	35.7	32.6	32.2	31.7	28.9	30.8
56ft (17.0m)		30.0	29.5	29.3	26.4	28.4
59ft (18.0m)		27.8	27.3	26.9	24.5	26.0
62ft (19.0m)			25.4	24.9	22.7	24.0
66ft (20.0m)				23.1	22.7	22.2
72ft (22.0m)				20.3	19.8	19.4
79ft (24.0m)				17.6	17.4	16.9
86ft (26.0m)					15.2	14.8
92ft (28.0m)						13.0
99ft (30.0m)						11.5

Lifting capacity with dragline boom head

43,200 lbs counterweight

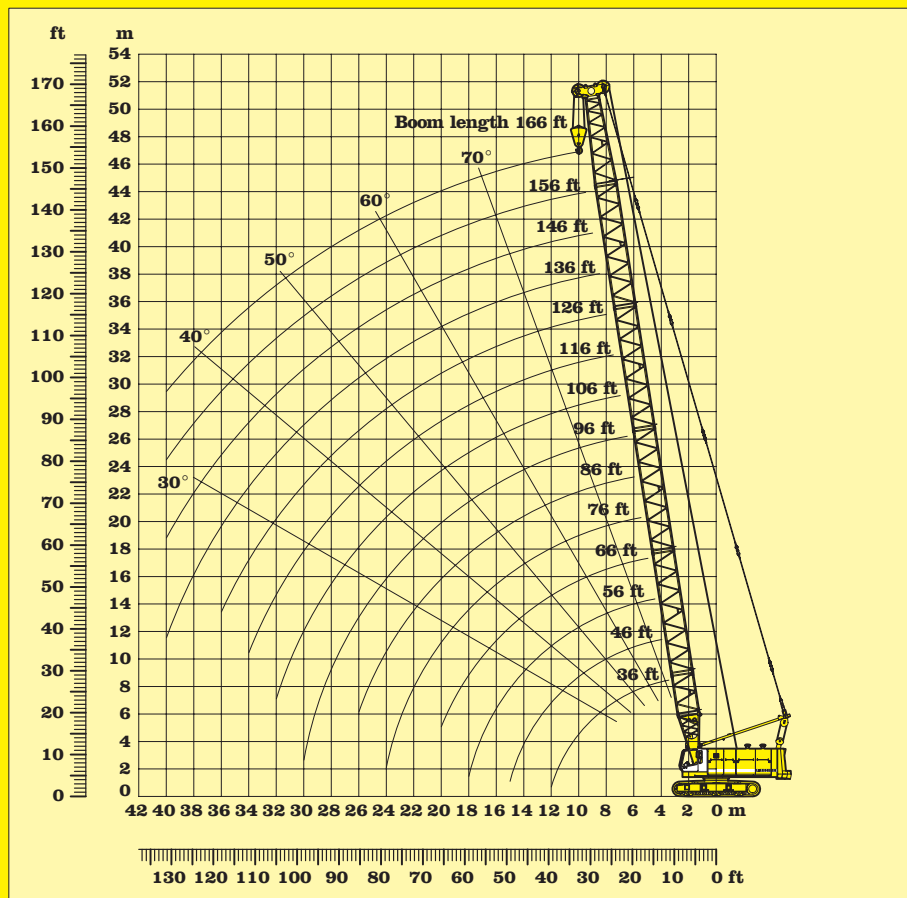

The following equipment is required:

- Basic machine with corresponding track shoes
- A-frame
- Boom foot 13 ft (4 m)
- Boom extension 10 ft (3 m) tubular steel
- Boom extension 20 ft (6 m) tubular steel
- Boom extension 30 ft (9 m) tubular steel
- Boom head section 21 ft (6.4 m)
- Boom head with interchangeable pulleys
- Stay ropes according to boom length
- Main winches according to specification
- Hoist limit switch
- Load moment limitation
- Corresponding ropes optional
- Corresponding hook block optional

Remarks:

1. The lifting capacities are valid for wide track.
2. The lifting capacities stated do not exceed 75% of tipping load
3. The lifting capacities are indicated in metric tons with unlimited swing (360 degrees)
4. The weight of the lifting device must be deducted to arrive at the lifting capacity.
5. Working radii are measured from centre of swing.
6. Crane standing on firm, horizontal ground.
7. Indicated values on load chart are affected by off-lead operation, wind speeds, load under slew and stop/go movements.

Capacities in 1000 lbs for boom lengths from 36ft (11m) to 166ft (50m):												Counterweight 43,200 lbs			
Boom length	36ft	46ft	56ft	66ft	76ft	86ft	96ft	106ft	116ft	126ft	136ft	146ft	156ft	166ft	
	(11m)	(14m)	(17m)	(20m)	(23m)	(26m)	(29m)	(32m)	(35m)	(38m)	(41m)	(44m)	(47m)	(50m)	
Radius in ft (m)	lbs	lbs	lbs	lbs	lbs	lbs	lbs	lbs	lbs	lbs	lbs	lbs	lbs	lbs	
13ft (4.0m)	198.4														
15ft (4.5m)	176.4	157.1													
16ft (5.0m)	158.3	151.7	141.5												
18ft (5.5m)	134.7	141.3	134.5	128.3											
20ft (6.0m)	117.0	116.8	116.8	116.6	116.2										
21ft (6.5m)	103.2	103.2	102.9	102.7	102.5	102.3									
23ft (7.0m)	92.4	92.4	92.1	91.7	91.5	91.3	90.8	89.3							
26ft (8.0m)	75.8	75.8	75.6	75.6	74.9	74.7	74.3	74.0	73.6	73.2					
30ft (9.0m)	64.1	64.1	63.9	62.1	63.3	63.0	62.6	62.2	61.7	61.3	61.0	45.4			
33ft (10.0m)	55.3	55.3	55.1	54.9	54.4	54.2	53.8	53.3	52.1	52.5	52.0	41.9	33.3	26.9	
39ft (12.0m)	42.7	43.0	42.7	42.5	42.3	41.9	41.4	41.0	40.6	40.1	39.7	35.7	28.2	22.9	
46ft (14.0m)		34.8	34.6	34.4	33.9	33.7	33.2	32.8	32.4	31.9	31.5	30.6	24.7	19.6	
53ft (16.0m)			28.7	28.4	28.2	27.8	27.3	26.9	26.4	26.0	25.6	25.1	21.4	16.7	
59ft (18.0m)			24.2	24.0	23.8	23.4	22.9	22.5	22.0	21.6	21.2	20.7	18.7	14.5	
66ft (20.0m)				20.5	20.3	19.8	19.6	19.2	18.7	18.0	17.6	17.2	16.5	12.6	
72ft (22.0m)					17.4	17.2	16.7	16.3	15.8	15.4	15.0	14.5	13.9	10.8	
79ft (24.0m)					15.2	14.8	14.5	14.1	13.7	13.2	12.6	12.1	11.5	9.3	
86ft (26.0m)						13.0	12.5	12.1	11.7	11.2	10.6	10.1	9.5	7.9	
92ft (28.0m)								11.0	10.6	9.9	9.5	8.8	8.4	7.7	
99ft (30.0m)								9.3	9.0	8.4	7.9	7.5	6.8	6.4	
106ft (32.0m)									7.7	7.3	6.6	6.2	5.5	5.1	
112ft (34.0m)										5.9	5.5	5.1	4.4	4.0	
118ft (36.0m)											4.6	4.2	3.9	3.5	
126ft (38.0m)												3.1	2.6	2.0	

Lifting capacity with multi sheave HD boom head

43,200 lbs basic + 9,900 lbs add. counterweight

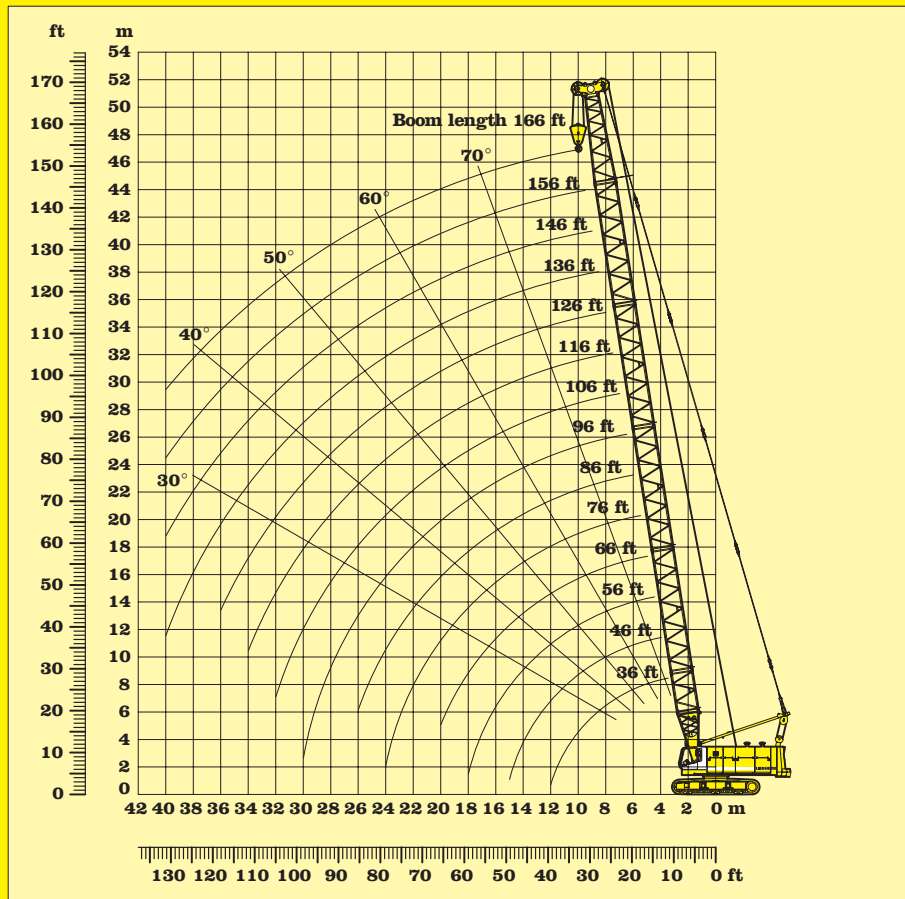

The following equipment is required:

- Basic machine with corresponding track shoes
- Add. counterweight 9,900 lbs (4.5t)
- A-frame
- Boom foot 13 ft (4 m)
- Boom extension 10 ft (3 m) tubular steel
- Boom extension 20 ft (6 m) tubular steel
- Boom extension 30 ft (9 m) tubular steel
- Boom head section 21 ft (6.4 m)
- Boom head with interchangeable pulleys
- Stay ropes according to boom length
- Main winches according to specification
- Hoist limit switch
- Load moment limitation
- Corresponding ropes optional
- Corresponding hook block optional

Remarks:

1. The lifting capacities are valid for wide track.
2. The lifting capacities stated do not exceed 75% of tipping load
3. The lifting capacities are indicated in metric tons with unlimited swing (360 degrees)
4. The weight of the lifting device must be deducted to arrive at the lifting capacity.
5. Working radii are measured from centre of swing.
6. Crane standing on firm, horizontal ground.
7. Indicated values on load chart are affected by off-lead operation, wind speeds, load under slew and stop/go movements.

Capacities in 1000 lbs for boom lengths from 36ft (11m) to 166ft (50m):										Counterweight 53,100 lbs					
Boom length	36ft (11m)	46ft (14m)	56ft (17m)	66ft (20m)	76ft (23m)	86ft (26m)	96ft (29m)	106ft (32m)	116ft (35m)	126ft (38m)	136ft (41m)	146ft (44m)	156ft (47m)	166ft (50m)	
Radius in ft (m)	lbs	lbs	lbs	lbs	lbs	lbs	lbs	lbs	lbs	lbs	lbs	lbs	lbs	lbs	
13ft (4.0m)	220.4														
15ft (4.5m)	189.6	157.2													
16ft (5.0m)	162.3	150.4	141.5												
18ft (5.5m)	150.1	145.9	136.7	128.3											
20ft (6.0m)	130.5	130.5	130.3	124.1	116.6										
23ft (7.0m)	103.2	103.1	102.9	102.7	102.3	100.5	94.8	89.3							
26ft (8.0m)	84.9	84.9	84.6	84.4	84.0	83.8	83.3	82.9	79.8	75.2					
30ft (9.0m)	71.9	71.9	71.6	71.4	71.0	70.8	70.3	69.9	69.4	69.0	62.6	45.4			
33ft (10.0m)	32.2	62.2	61.9	61.5	61.3	60.8	60.4	60.1	59.7	59.3	52.0	41.9	33.3	26.9	
39ft (12.0m)	48.3	48.5	48.3	48.1	47.6	47.2	46.7	46.5	46.1	45.6	45.0	35.7	28.2	22.9	
46ft (14.0m)		39.2	39.2	38.8	38.6	38.1	37.7	37.2	36.8	36.4	35.9	30.6	24.7	19.6	
53ft (16.0m)			32.6	32.4	31.9	31.5	31.3	30.8	30.4	30.0	29.3	26.9	21.4	16.7	
59ft (18.0m)			27.6	27.3	27.1	26.7	26.2	25.8	25.3	24.9	24.5	23.8	18.7	14.5	
66ft (20.0m)				23.6	23.4	22.9	22.5	22.0	21.6	21.2	20.7	20.3	16.5	12.6	
72ft (22.0m)					20.3	19.8	19.4	18.9	18.5	18.1	17.6	17.2	14.5	10.8	
79ft (24.0m)					17.6	17.4	16.9	16.5	16.1	15.6	15.2	14.8	12.8	9.3	
86ft (26.0m)						15.2	14.8	14.3	13.9	13.4	13.0	12.3	11.2	7.9	
92ft (28.0m)							13.0	12.6	12.1	11.7	11.0	10.6	9.9	6.6	
99ft (30.0m)							11.2	11.0	10.6	9.9	9.5	8.8	8.4	5.5	
106ft (32.0m)								9.5	9.0	8.6	8.1	7.5	6.8	4.6	
112ft (34.0m)									7.9	7.3	6.8	6.2	5.7	3.7	
118ft (36.0m)										6.2	5.7	5.1	4.6	2.9	
126ft (38.0m)											4.6	4.2	3.5	2.2	
131ft (40.0m)												3.7	3.3	1.5	

LIEBHERR-WERK NENZING GMBH, P.O. Box 10, A-6710 Nenzing / Austria / Europe
 Telephone (+ + 43) 5525 - 606 - 0,
 Telex 52141 lwn a, Telefax (+ + 43) 5525 - 606 - 499

Presented by: