

Technical data
Hydraulic lift crane

LR 1160 W
Litronic®

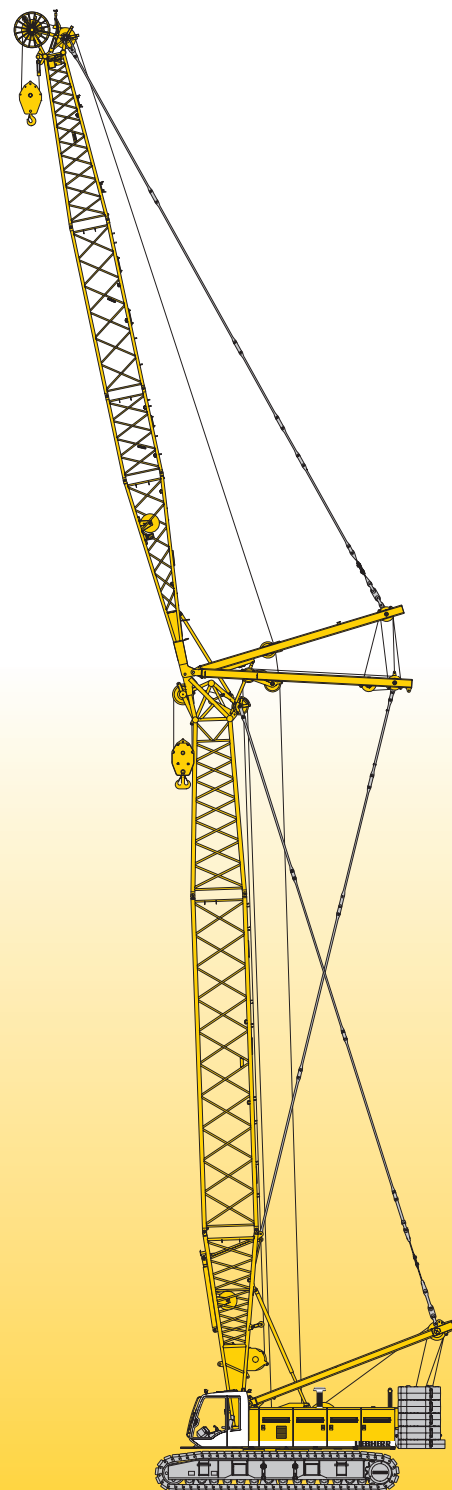

LIEBHERR

Dimensions

Basic machine with undercarriage

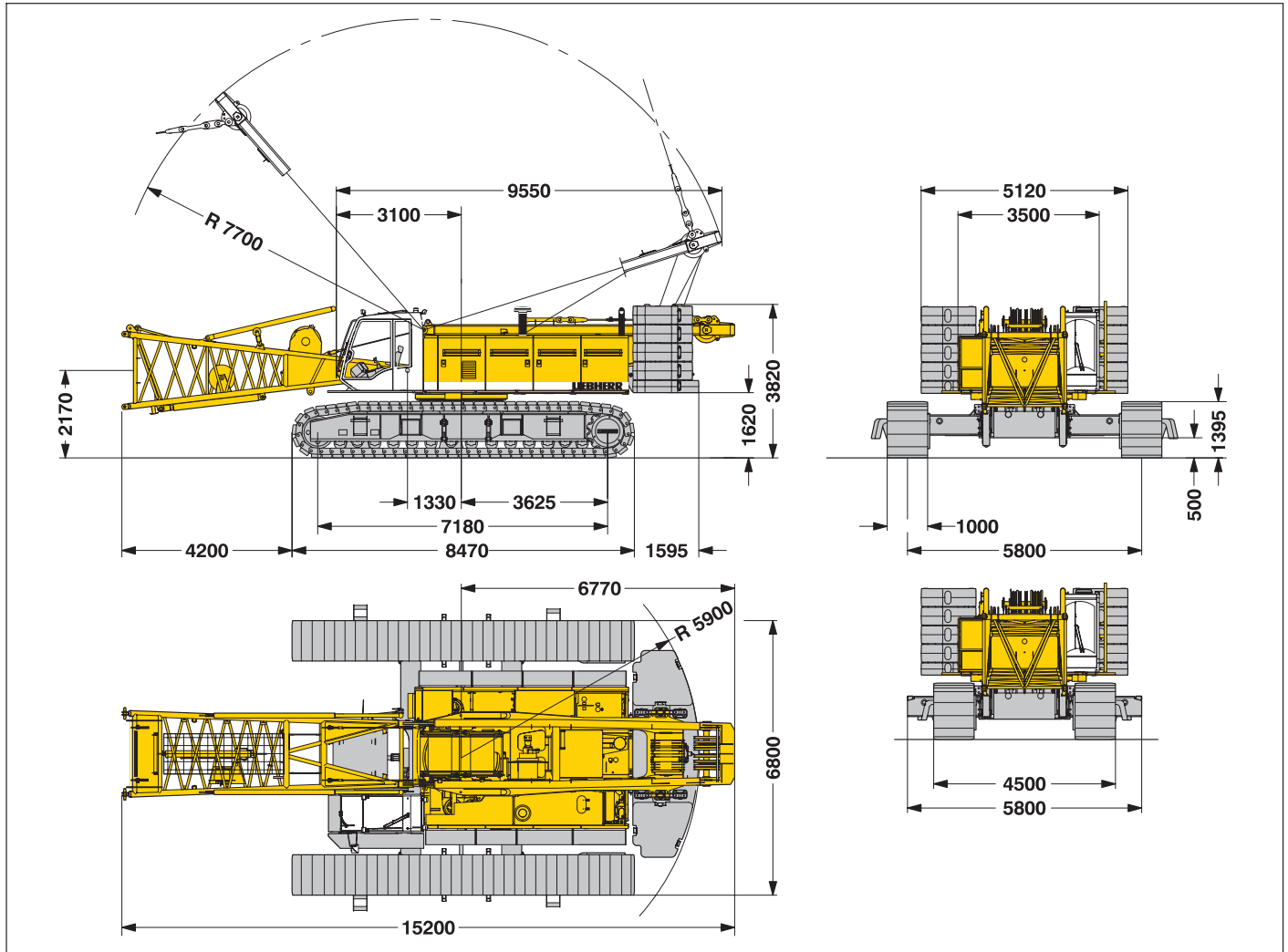

Operating weight

The operating weight includes the basic machine with crawlers, 2 main winches 120 kN and 20 m main boom, consisting of A-frame, boom foot (7 m), boom head (7 m), boom extension (6.0 m), 55 t basic counterweight, 15 t carbody counterweight and 160 t hook block.

Total weight _____ approx. 157.7 t

Ground pressure

Ground bearing pressure _____ 1.095 kg/cm²

Equipment

Main boom (No. 2018.xx) max. length _____ 87.5 m
 High reach (No. 2018.xx and 1309.xx) _____ 104.9 m
 Luffing jib (No. 1309.xx) max. length _____ 78.5 m
 Max. combination _____ boom 52.1 m and luffing jib 78.5 m
 Luffing jib (No. 1713.xx) max. length _____ 83.0 m
 Max. combination _____ boom 49.1 m and luffing jib 83.0 m
 Fixed jib (No. 0806.xx) _____ 11 m – 32 m
 Fixed jib (No. 1008.xx) _____ 11 m – 26 m
 Auxiliary jib 24 t lifting capacity (option 36 t)

Remarks

1. The lifting capacities stated are valid for lifting operation only (corresponds with crane classification according to F.E.M. 1.001, crane group A1).
2. Crane standing on firm, horizontal ground.
3. The weight of the lifting device (hoisting ropes, hook block, shackle etc.) must be deducted from the gross lifting capacity to obtain a net lifting value.
4. Additional equipment on boom (e.g. boom walkways, auxiliary jib) must be deducted to get the net lifting capacity.
5. For max. wind speed please refer to lift chart in operator's cab or manual.
6. Working radii are measured from centre of swing and under load.
7. The lifting capacities are valid for 360 degrees of swing.
8. Calculation of stability under load is based on DIN 15019 / part 2 / chart 1 and ISO 4305 Table 1 + 2, tipping angle 4°.
9. The structures are calculated according to F.E.M. 1.001 – 1998 (prEN 13001 / T2 / 1997).

Transport dimensions and weights

Basic machine and boom (No. 2018.xx)

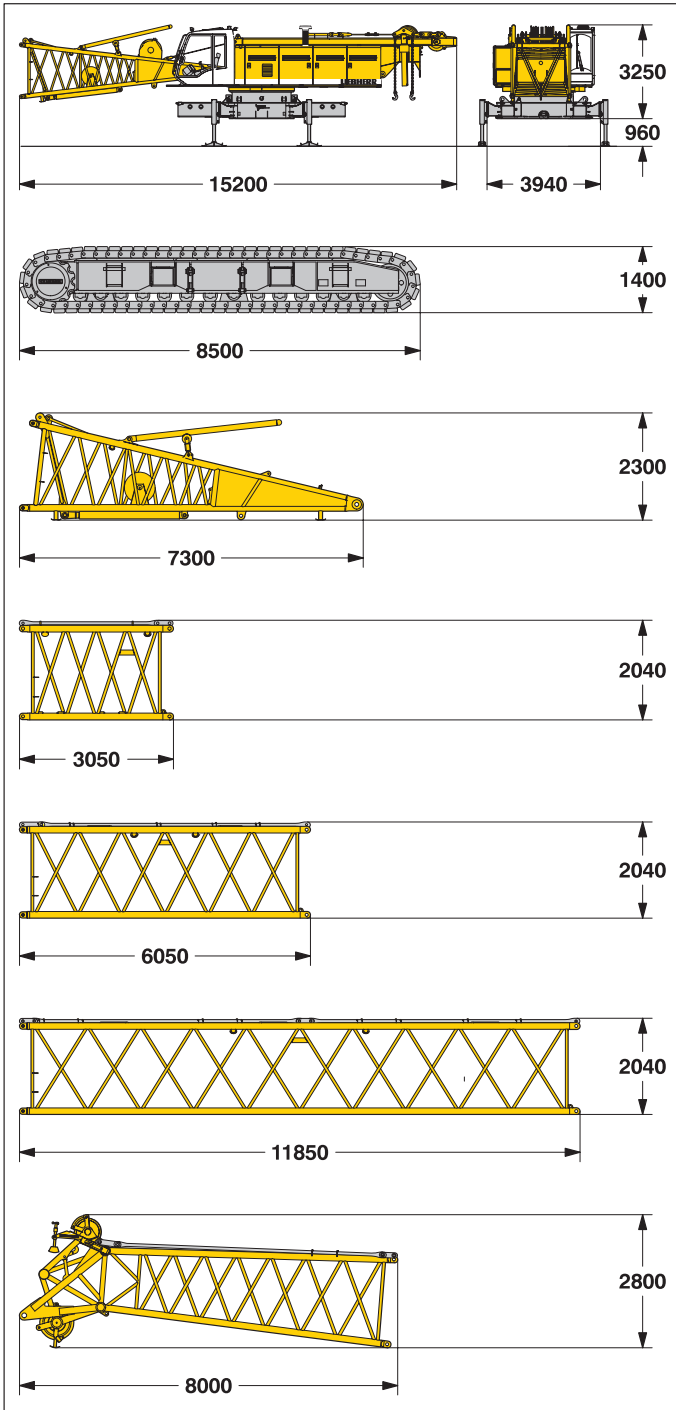

Basic machine

with A-frame, 2x 120 kN crane winches and boom foot, without hoisting ropes, basic counterweight and crawlers

Width	mm	3500
Weight	kg	39700

Crawler

2x

Flat track shoes	mm	1000
Width	mm	1400
Weight	kg	18800

Boom foot (No. 2018.xx) without winches

Width	mm	2420
Weight	kg	3200

Boom section (No. 2018.xx)

3 m

Width	mm	2280
Weight*	kg	760

Boom section (No. 2018.xx)

6 m

Width	mm	2280
Weight*	kg	1100

Boom section (No. 2018.xx)

11.7 m

Width	mm	2280
Weight*	kg	1900

Boom head No. 2018.xx)

Width	mm	2280
Weight*	kg	2700

Transport option

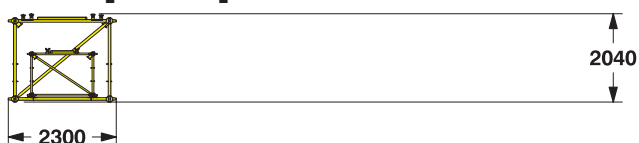

*) Including pendants

Boom - luffing jib transport option

11.7 m boom – and 11.7 m jib extension
6 m boom – and 6.0 m jib extension

(No. 2018.xx / 1309.xx)		6m/6m	11.7m/11.7m
Length	mm	6150	11850
Weight*	kg	1740	3160

Transport dimensions and weights

Luffing jib (No. 1309.xx)

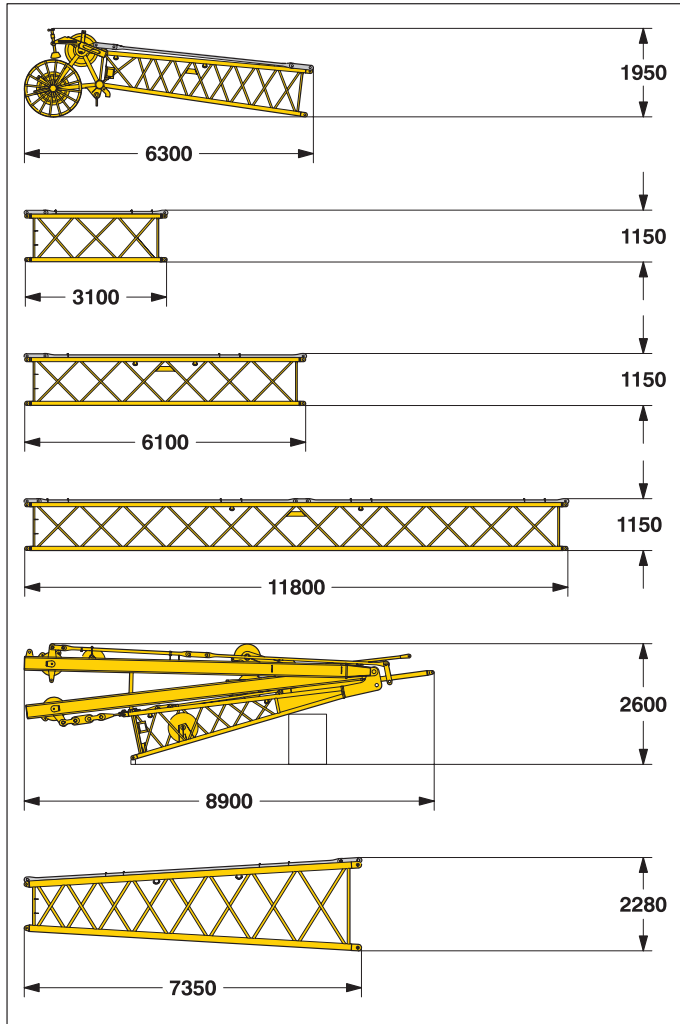

Luffing jib head (No. 1309.xx)

Width	mm	1500
Weight*	kg	1135

Luffing jib section (No. 1309.xx) **3 m**

Width	mm	1500
Weight*	kg	420

Luffing jib section (No. 1309.xx) **6 m**

Width	mm	1500
Weight*	kg	520

Luffing jib section (No. 1309.xx) **11.7 m**

Width	mm	1500
Weight*	kg	960

Luffing jib foot with A-frames (No. 1309.xx)

Width	mm	1700
Weight*	kg	4800

Boom section tapered (No. 2018/1309.xx) **7.2 m**

Width	mm	2280
Weight*	kg	1225

Fixed jib (No. 0806.xx)

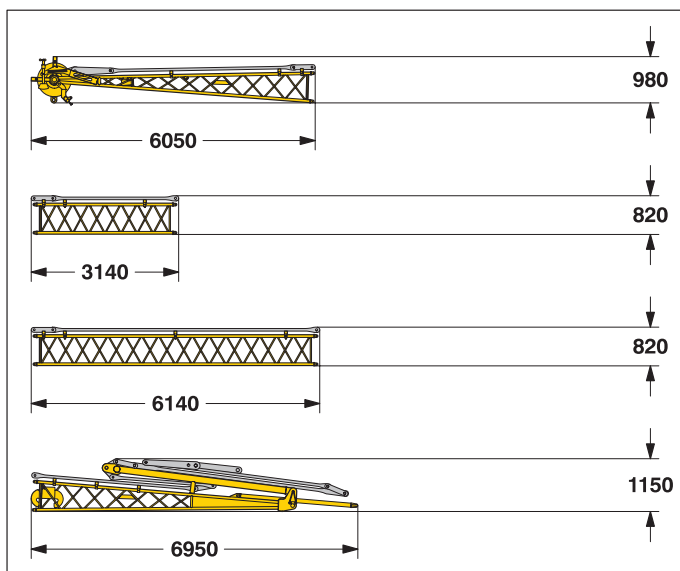

Fixed jib head (No. 0806.xx)

Width	mm	1140
Weight*	kg	445

Fixed jib section (No. 0806.xx) **3 m**

Width	mm	950
Weight*	kg	110

Fixed jib section (No. 0806.xx) **6 m**

Width	mm	950
Weight*	kg	195

Fixed jib foot with A-frame (No. 0806.xx)

Width	mm	1500
Weight*	kg	930

*) Including pendants

Transport dimensions and weights

Luffing jib (No. 1713.xx)

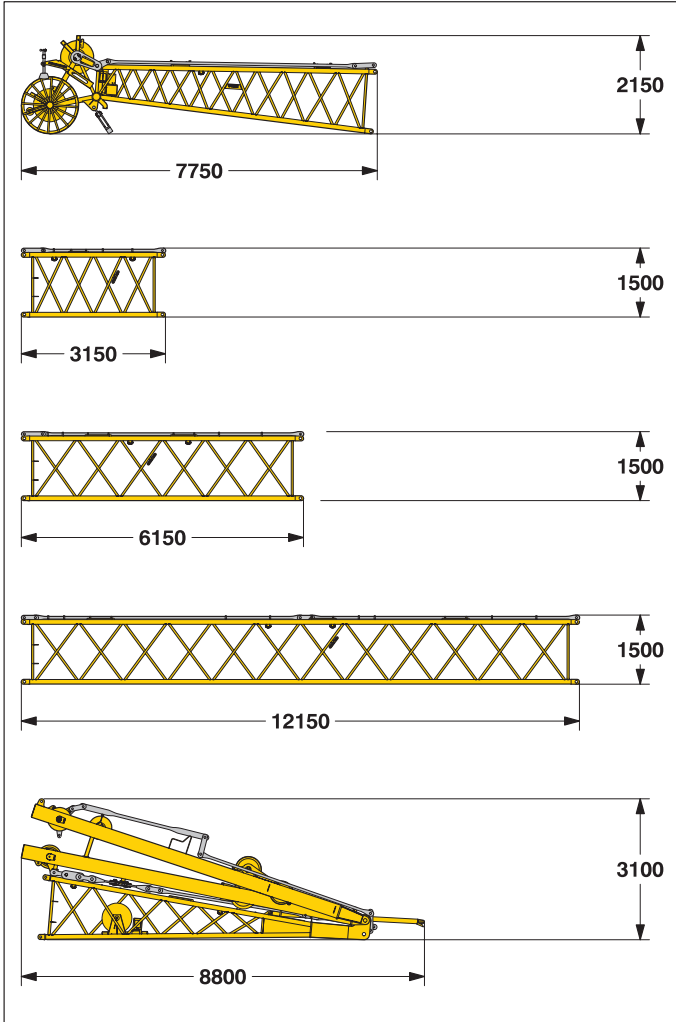

Luffing jib head (No. 1713.xx)

Width	mm	1500
Weight*	kg	1135

Luffing jib section (No. 1713.xx) **3 m**

Width	mm	1500
Weight*	kg	420

Luffing jib section (No. 1713.xx) **6 m**

Width	mm	1500
Weight*	kg	520

Luffing jib section (No. 1713.xx) **12 m**

Width*	mm	1500
Weight	kg	960

Luffing jib foot with A-frames (No. 1713.xx)

Width	mm	1700
Weight*	kg	4800

Fixed jib (No. 1008.xx)

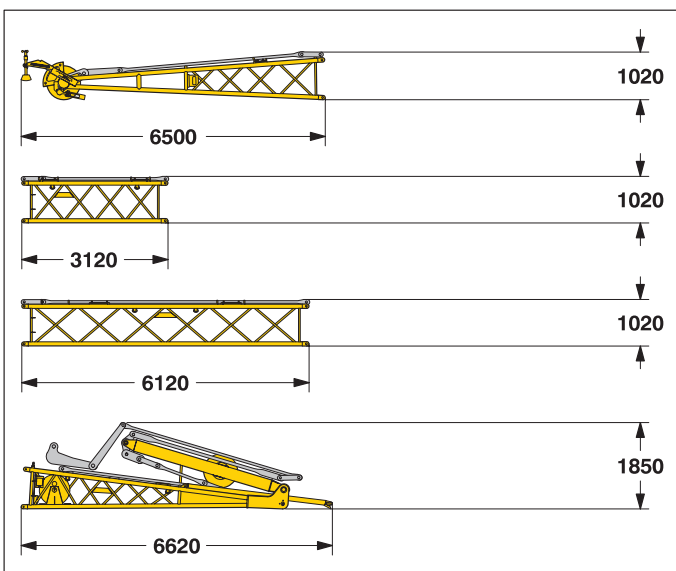

Fixed jib head (No. 1008.xx)

Width	mm	1140
Weight*	kg	935

Fixed jib section (No. 1008.xx) **3 m**

Width	mm	1100
Weight*	kg	300

Fixed jib section (No. 1008.xx) **6 m**

Width	mm	1100
Weight*	kg	460

Fixed jib foot with A-frame (No. 1008.xx)

Width	mm	1500
Weight*	kg	1950

*) Including pendants

Transport dimensions and weights

Counterweights and hooks

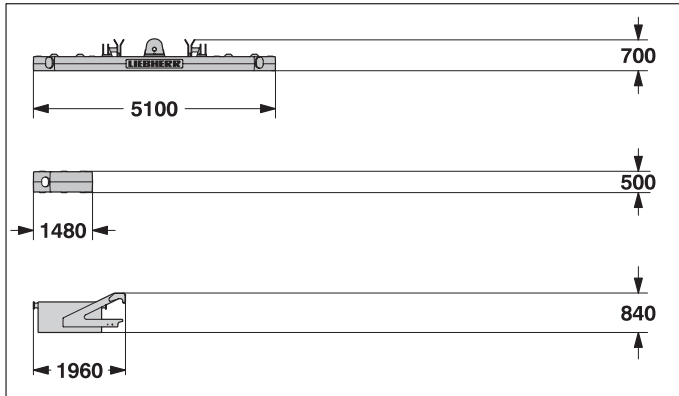

Counterweight **1x**

Width	mm	1600
Weight	kg	14300

Counterweight **8x**

Width	mm	1360
Weight	kg	5100

Carbody counterweight **2x**

Width	mm	1640
Weight	kg	7500

Mid fall (option)

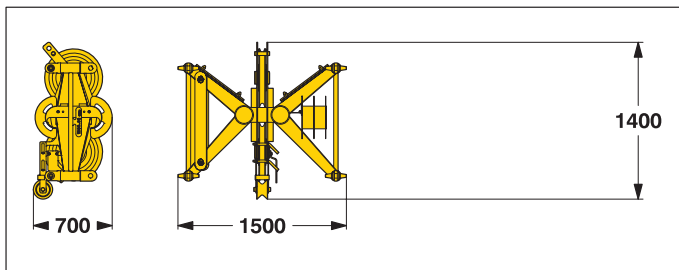

Mid fall section (No. 1309.xx) **0.35 m**

Width	mm	700
Weight	kg	270

Hooks

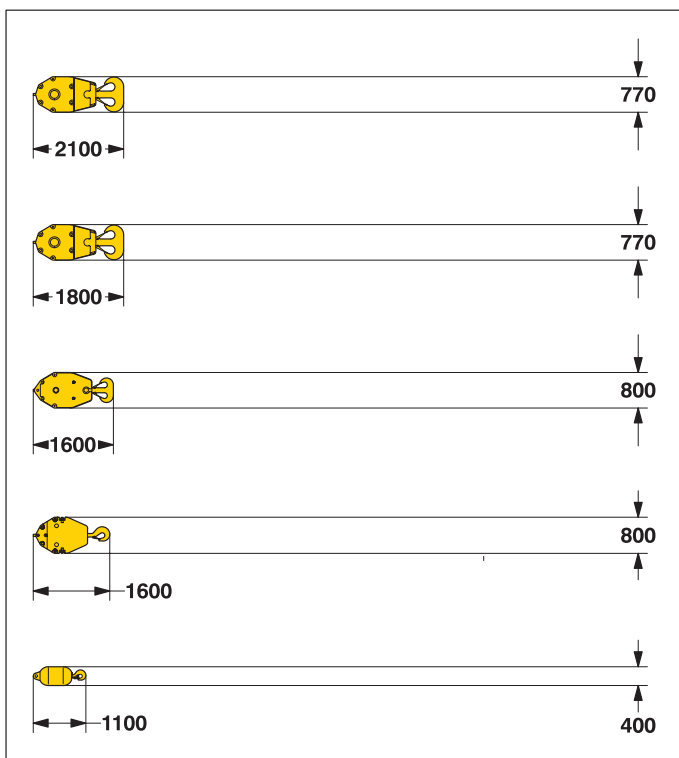

160 t hook block - 7 sheaves

Width	mm	640	760	880
Weight	kg	1500	2250	3000

100 t hook block - 5 sheaves

Width	mm	540	640	770
Weight	kg	1300	1800	2300

80 t hook block - 3 sheaves

Width	mm	560
Weight	kg	2000

40 t hook block - 1 sheave

Width	mm	300	400	500
Weight	kg	700	1100	1500

12 t single hook

Width	mm	400
Weight	kg	600

Technical description



Engine

Power rating according to ISO 9249, 240 kW (326 PS) at 2000 rpm
Engine type _____ Liebherr D 926 TI-E
Fuel tank _____ 780 l capacity with continuous level indicator
and reserve warning
Complies with EPA CARB II / TIER II / and 97/68 EC TIER II OFF-ROAD



Hydraulic system

A double axial displacement pump supplies the open loop hydraulic system, allowing all functions to be operated simultaneously. To minimize peak pressure an automatic working pressure cut-off is integrated in the pump. All filters are electronically monitored.
The use of synthetic environmentally friendly (biodegradable) oils is possible.
Working pressure _____ max. 350 bar
Oil tank capacity _____ 650 l



Luffing jib winch

Line pull _____ max. 105 kN
Rope diameter _____ 20 mm
Jib luffing _____ 46 sec. from 15° to 78°



Boom winch

Line pull _____ max. 176 kN
Rope diameter _____ 24 mm
Boom up _____ 104 sec. from 15° to 86°



Swing

Consists of rollerbearing with external teeth, swing drive with fixed axial piston hydraulic motor, spring loaded and hydraulically released multi-disc holding brake, planetary gearbox and pinion.
Free swing with hydraulic moment control reduces wear to a minimum. Alternatively the swing control can be changed to simulate closed loop speed control. Then a multi-disc holding brake acts automatically at zero swing motion.
Swing speed from 0 – 3 rpm continuously variable.



Main winches

Line pull (1st layer) _____ max. 175 kN
Line pull (7th layer) _____ 120 kN
Rope diameter _____ 26 mm
Drum diameter _____ 580 mm
Rope speed m/min _____ 0 – 136
Rope capacity in 7 layers _____ 470 m
The winches are outstanding in their compact design and easy assembly. Propulsion is via a planetary gearbox in an oil bath.
Load support by the hydraulic system; additional safety factor provided by a spring loaded, multi-disc holding brake.
The main winches use pressure controlled, variable flow hydraulic motors. This system features sensors that automatically adjust oil flow to provide max. winch speed depending on load.
Option – winch with freefall system:
Clutch and braking functions on the freefall system are provided by a compact designed, low wear and maintenance free multi-disc brake.



Crawlers

Propulsion through axial piston motor, hydraulically released spring loaded multi-disc brake, crawler tracks, hydraulic chain tensioning device.
Flat track shoes _____ 1000 mm
Drive speed _____ 0 – 1.5 km/h



Control

The control system – developed and manufactured by Liebherr – is designed to withstand extreme environmental conditions such as temperature, vibration and electromagnetic interference and to meet all requirements that are needed in heavy duty crane operation.
Complete machine operating data are shown on a high resolution display. Standard operational information is displayed by means of graphical symbols, fault indications are displayed in plain text (more than 10 languages available).
The cranes are equipped with proportional control for all main movements, which can be carried out simultaneously.
A backup control system, that allows limited use of the crane is standard. This feature increases the safety and availability of the crane even further. The crane is operated with 2 multi-directional joysticks, the right for winch I and boom, the left for winch II and swing control.
Option:
Bi-directional double T-levers for simultaneous boom and luffing jib operation.
The crawlers are activated by the two central foot pedals. Additionally, hand levers can be attached to the pedals.



Noise emission

Noise emissions correspond with 2000/14/EC directive on noise emission by equipment used outdoors.

Boom combinations

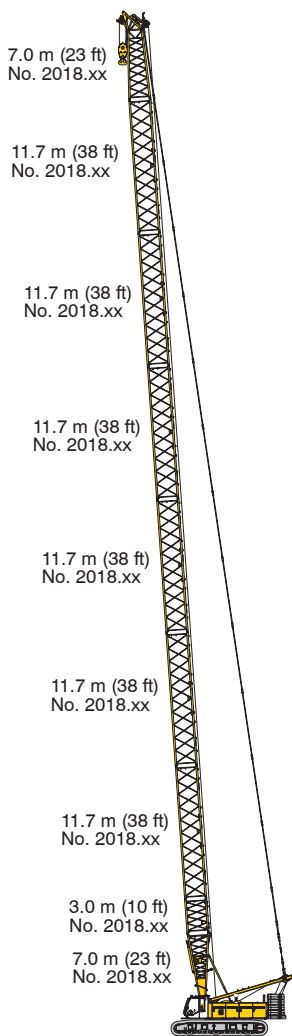

Main boom No. 2018.xx — 87.5 m

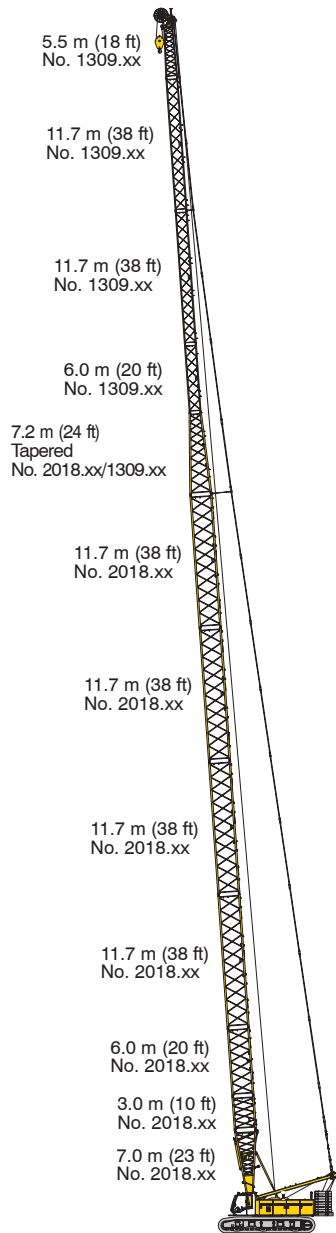

Max. combination — 104.9 m
Main boom No. 2018.xx — 62.8 m
Tapered No. 2018/1309.xx — 7.2 m
Luffing jib No. 1309.xx — 34.9 m

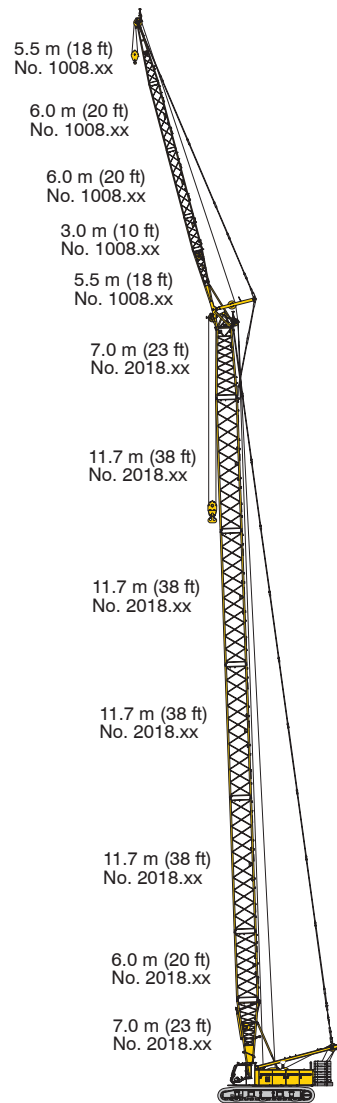

Max. combination — 92.8 m
Main boom No. 2018.xx — 66.8 m
Fixed jib No. 0806.xx — 26.0 m
Main boom No. 2018.xx — 69.8 m
Fixed jib No. 0806.xx — 20.0 m

Boom combinations

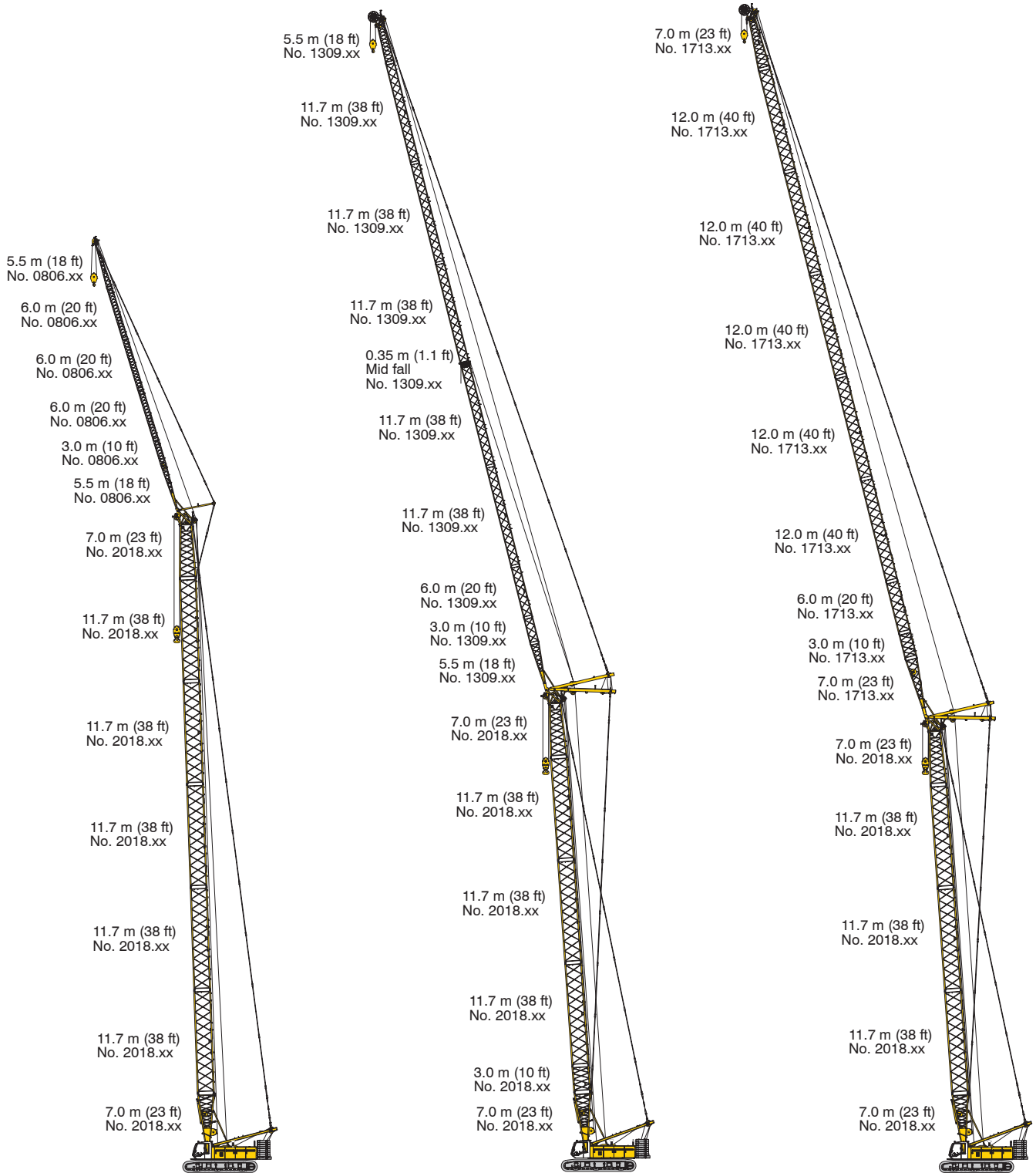

Max. combination — 104.5 m
 Main boom No. 2018.xx — 72.5 m
 Fixed jib No. 0806.xx — 32.0 m
 Main boom No. 2018.xx — 75.5 m
 Fixed jib No. 1008.xx — 29.0 m

Max. combination — 130.6 m
 Main boom No. 2018.xx — 52.1 m
 Luffing jib No. 1309.xx — 78.5 m
 Main boom No. 2018.xx — 55.1 m
 Luffing jib No. 1309.xx — 69.5 m

Max. combination — 132.1 m
 Main boom No. 2018.xx — 49.1 m
 Luffing jib No. 1713.xx — 83.0 m
 Main boom No. 2018.xx — 55.1 m
 Luffing jib No. 1713.xx — 56.0 m

Self assembly system

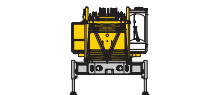

Unloading of basic machine

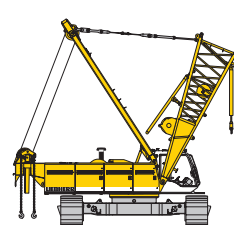
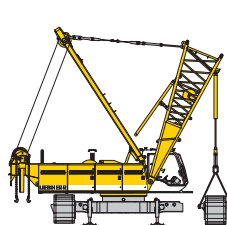
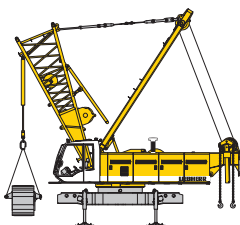
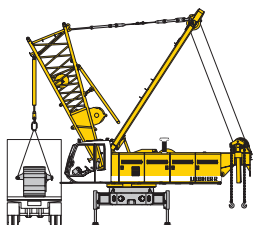

Unloading and assembly of crawlers

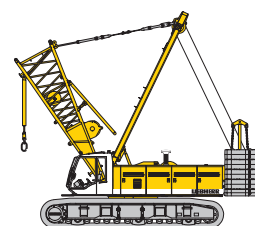
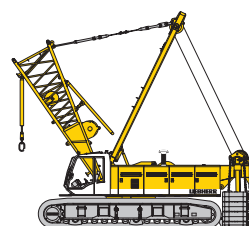
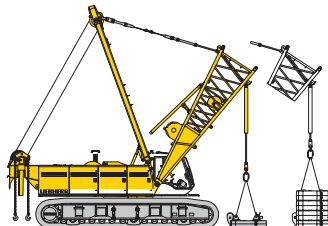
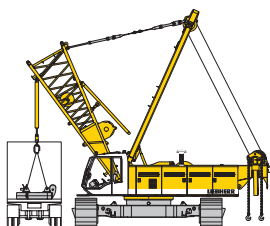

Unloading and assembly of counterweight

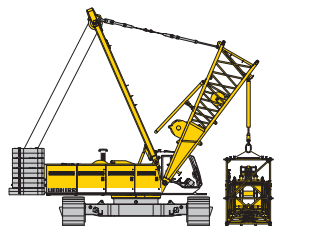
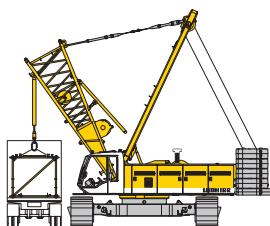

Unloading and assembly of boom

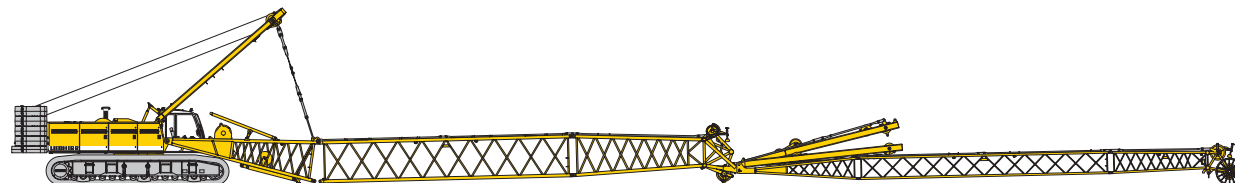

Assembly of boom

Erecting of main boom to working position

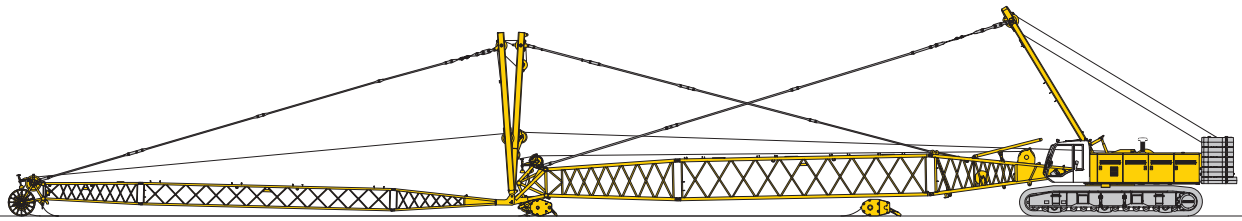

Reeving of hoist and luffing jib ropes



Erecting of main boom and luffing jib

Working position

Working range - main boom (No. 2018.xx) **86° - 15°** 55 t counterweight and 15 t carbody counterweight

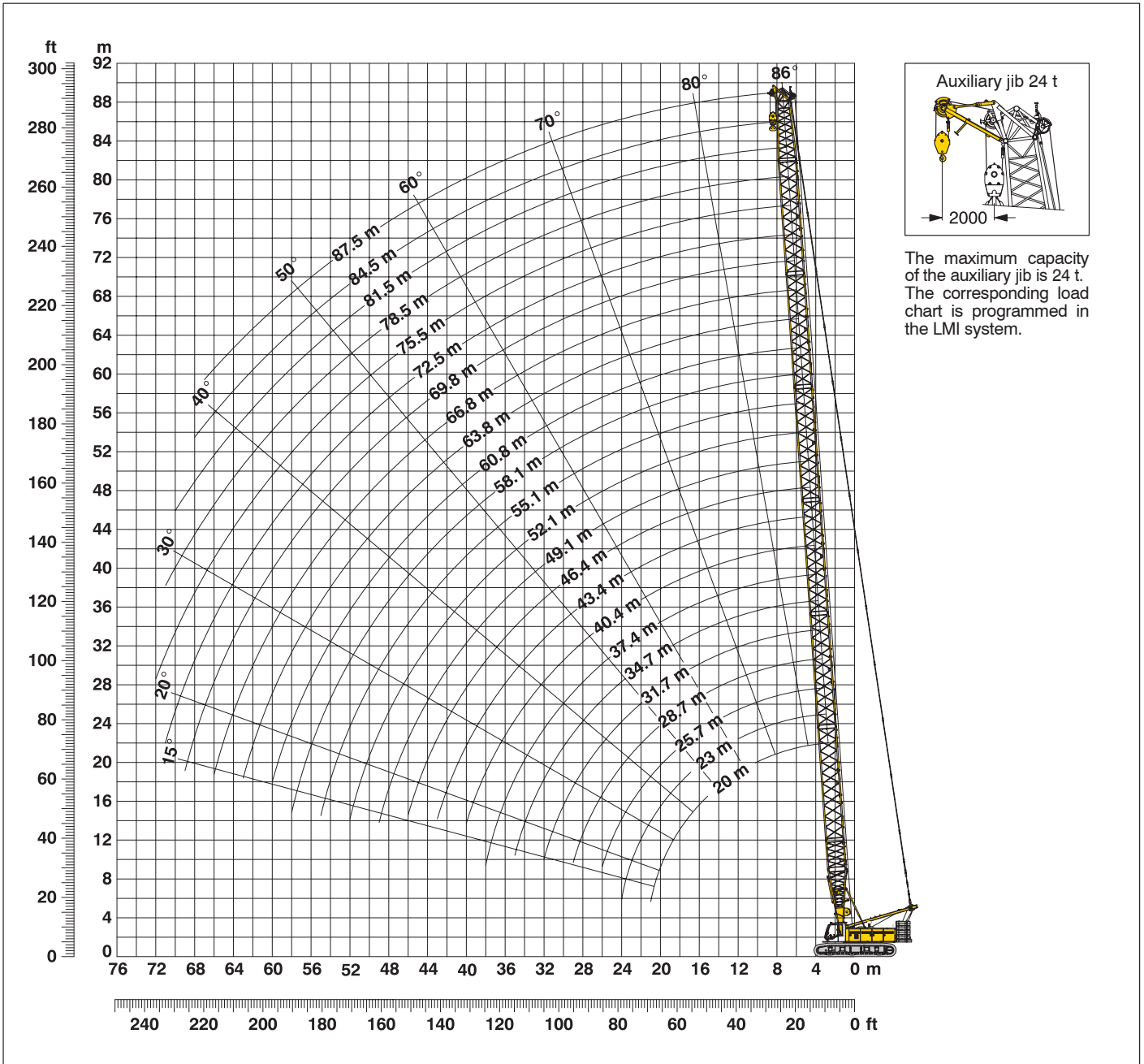

Main boom configuration (Table1 – No. 2018.xx)

Configuration for boom lengths between 20 m and 87.5 m:

	Length	Amount of boom extensions																							
		1	1	1	1	1	1	1	1	1	1	1	1	1	1	1	1	1	1	1	1				
Boom foot	7.0 m	1	1	1	1	1	1	1	1	1	1	1	1	1	1	1	1	1	1	1	1				
Boom insert	3.0 m		1		1		1		1		1		1		1		1		1		1				
Boom insert	6.0 m	1	1			1	1			1	1			1	1			1	1						
Boom insert	11.7 m			1	1	1	1	2	2	2	2	3	3	3	3	4	4	4	4	5	5	5	5	5	5
Boom head	7.0 m	1	1	1	1	1	1	1	1	1	1	1	1	1	1	1	1	1	1	1	1	1	1	1	1
Boom length (m)		20	23	25.7	28.7	31.7	34.7	37.4	40.4	43.4	46.4	49.1	52.1	55.1	58.1	60.8	63.8	66.8	69.8	72.5	75.5	78.5	81.5	84.5	87.5

Lift chart for main boom (No. 2018.xx)

Capacities in metric tons for boom lengths (20 m – 87.5 m) – with 120 kN winches
55.0 t counterweight and 15 t carbony counterweight

Radius	Boom length in (m)												Radius	
	20	28.7	34.7	40.4	46.4	52.1	58.1	63.8	69.8	75.5	81.5	87.5		
(m)	t	t	t	t	t	t	t	t	t	t	t	t	t	(m)
3.7	160.0*													3.7
5	137.2	136.2	126.4											5
6	136.1	126.7	115.9	102.4	86.4	69.5								6
7	118.1	106.6	98.6	92.1	82.7	68.2	57.0	45.4						7
8	102.2	90.7	85.7	79.0	75.7	64.7	55.3	44.9	37.9	31.5	26.1			8
9	88.7	78.5	75.7	71.5	67.5	61.6	53.3	43.6	36.9	31.0	26.0	21.4		9
10	78.3	71.7	67.3	64.2	60.9	56.8	51.2	42.3	34.6	30.2	25.4	21.1		10
12	61.3	57.6	55.7	53.2	50.7	48.4	44.5	38.9	32.8	28.7	24.1	20.0		12
14	49.4	49.4	46.3	45.2	43.2	41.4	39.6	33.4	30.8	27.2	22.5	18.9		14
16	41.2	41.2	40.7	39.1	37.5	36.0	33.9	31.3	28.9	25.7	21.3	17.8		16
18	35.1	35.2	35.0	34.4	33.0	31.8	30.5	29.0	27.0	24.4	20.1	16.6		18
20	30.4	30.5	30.4	30.2	29.4	28.3	27.1	26.1	25.0	22.4	19.2	15.7		20
22		26.9	26.7	26.6	26.3	25.4	24.4	23.2	22.5	21.4	18.3	15.0		22
24		23.9	23.7	23.6	23.3	23.0	22.0	21.2	20.3	19.5	17.3	14.2		24
26		21.4	21.3	21.1	20.9	20.6	20.0	19.3	18.4	17.7	16.3	13.4		26
28		19.3	19.2	19.1	18.8	18.6	18.3	17.6	16.8	16.1	15.3	12.6		28
30			17.4	17.3	17.0	16.8	16.5	16.1	15.3	14.7	14.0	12.2		30
32			15.9	15.8	15.5	15.3	15.0	14.7	14.1	13.4	12.8	11.1		32
34			14.5	14.5	14.2	14.0	13.7	13.4	12.9	12.3	11.7	10.8		34
36				13.3	13.0	12.8	12.5	12.2	11.6	11.4	10.8	10.1		36
38				12.2	12.0	11.8	11.5	11.2	10.9	10.5	9.9	9.3		38
40				11.3	11.1	10.9	10.6	10.3	10.0	9.7	9.1	8.5		40
42					10.3	10.0	9.7	9.5	9.2	8.9	8.3	7.8		42
44					9.5	9.3	9.0	8.7	8.4	8.1	7.7	7.1		44
46					8.8	8.6	8.3	8.0	7.7	7.4	7.1	6.5		46
48						8.0	7.7	7.4	7.1	6.8	6.5	5.9		48
50						7.4	7.1	6.8	6.5	6.2	5.9	5.4		50
55							5.8	5.6	5.3	5.0	4.7	4.3		55
60								4.6	4.2	4.0	3.6	3.3		60
65									3.4	3.1	2.8	2.4		65
70										2.3	2.0			70

Above lift chart is for reference only. For actual lift duty please refer to lift chart in operator's cab or manual.

* Capacities over 140 t require a special heavy duty boom head.

L – boom high reach (No.2018 / 1309.xx) **66.8 m – 104.9 m**

Working range **86° - 15°**

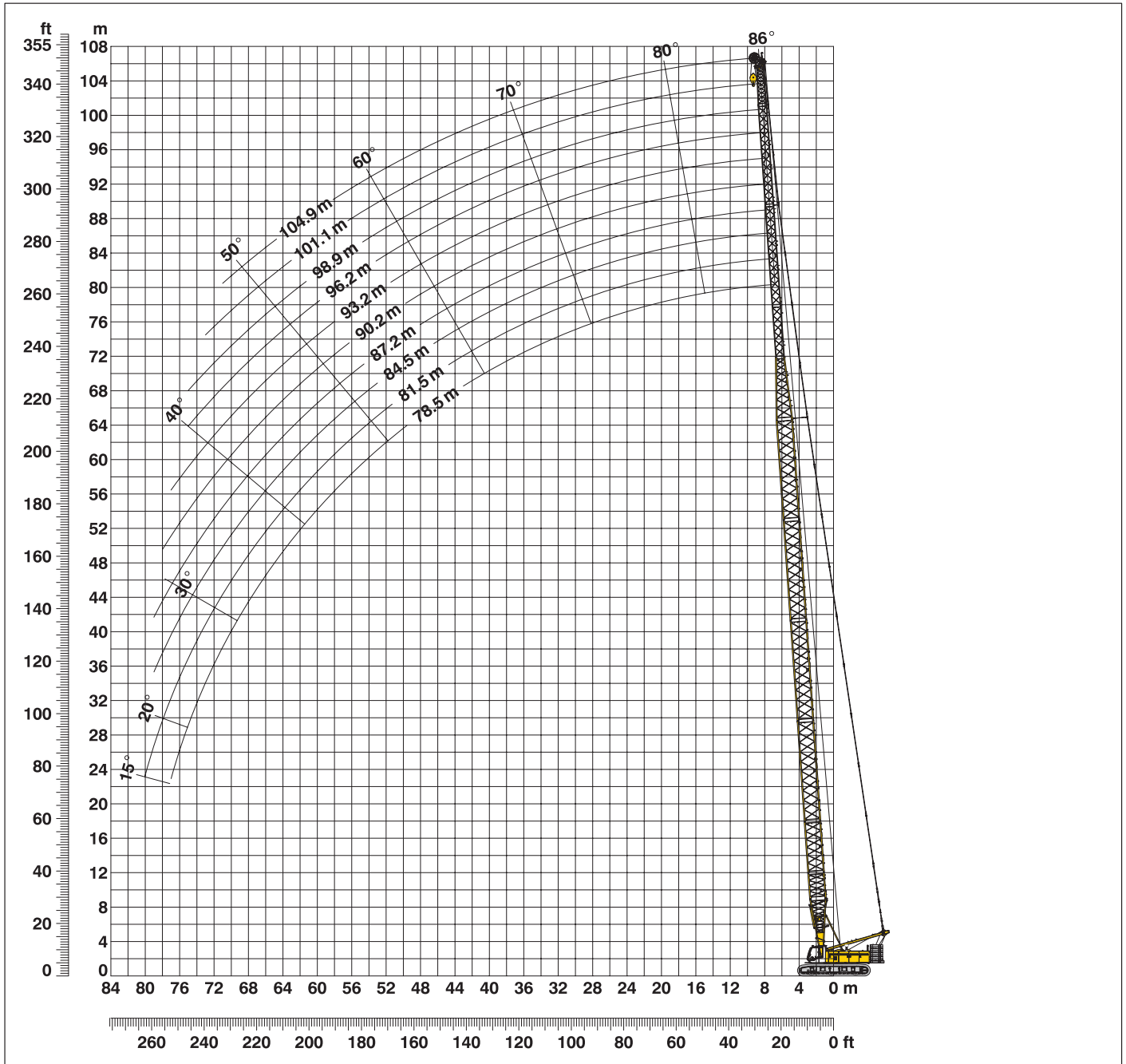

L – boom configuration with 51.1 m main boom (No. 2018.xx / No. 1309.xx)

Configuration for L – boom lengths (60.5 m – 98.6 m)

Length	Amount of boom and luffing jib extensions												
	7.0 m	3.0 m	6.0 m	11.7 m	7.2 m	3.0 m	6.0 m	11.7 m	5.5 m	7.0 m	3.0 m	6.0 m	11.7 m
Boom foot	1	1	1	1	1	1	1	1	1	1	1	1	1
Boom insert	1	1	1	1	1	1	1	1	1	1	1	1	1
Boom insert	1	1	1	1	1	1	1	1	1	1	1	1	1
Boom insert	3	3	3	3	3	3	3	3	3	3	3	3	3
Tapered	1	1	1	1	1	1	1	1	1	1	1	1	1
Luffing insert	1		1		1		1		1		1		1
Luffing insert		1	1			1	1				1	1	
Luffing insert				1	1	1	1	2	2	2	2	2	2
Luffing jib head	1	1	1	1	1	1	1	1	1	1	1	1	1
Max. L – boom length (m)	66.8	69.8	72.8	75.5	78.5	81.5	84.5	87.2	90.2	93.2	96.2		

Lift chart for L – boom (No. 2018 /1309.xx)

Main boom length 51.1 m

Capacities in metric tons 55.0 t counterweight and 15 t carbody counterweight					
Radius (m)	Boom length in (m)				
	66.8	78.5	84.5	90.2	96.2
6.5	41.7				
8	40.9	23.1	17.1		
9	39.9	22.4	16.7	12.6	8.2
10	38.8	21.5	16.0	12.2	8.0
12	36.0	19.9	14.7	10.9	7.5
14	32.5	18.5	13.6	10.1	7.0
16	28.1	17.3	12.5	9.3	6.6
18	24.9	16.1	11.3	8.6	6.1
20	21.4	15.1	10.6	8.0	5.8
22	19.9	14.2	10.0	7.3	5.5
24	18.5	13.3	9.4	6.9	5.2
26	17.2	12.6	8.8	6.5	4.9
28	15.8	11.5	8.3	6.1	4.7
30	14.7	11.1	7.9	5.7	4.5
32	13.5	10.7	7.4	5.4	4.2
34	12.3	10.3	6.9	5.1	4.0
36	11.6	9.9	6.6	4.8	3.8
38	10.8	9.4	6.4	4.6	3.6
40	10.0	9.0	6.1	4.4	3.4
42	9.2	8.5	5.9	4.3	3.3
44	8.5	7.9	5.6	4.1	3.2
46	8.0	7.4	5.5	4.0	3.0
48	7.4	6.8	5.3	3.8	2.9
50	6.9	6.2	5.1	3.7	2.8
55	5.8	5.3	4.7	3.4	2.6
60	4.8	4.5	4.1	3.2	2.4
65	4.1	3.8	3.6	3.0	2.3
70		3.2	3.1	2.7	2.1
75		2.7	2.5	2.4	
80			2.1		

Main boom length 62.8 m

Capacities in metric tons 55.0 t counterweight and 15 t carbody counterweight					
Radius (m)	Boom length in (m)				
	78.5	84.5	90.2	96.2	104.9
7.4	29.8				
8	29.8	23.2			
9	29.1	22.9	18.4	13.7	
10	28.4	22.4	17.8	13.5	9.0
12	27.0	21.3	16.7	12.5	8.6
14	25.8	20.4	15.7	11.3	8.2
16	23.0	19.4	14.7	10.5	7.8
18	21.4	18.6	13.9	9.8	7.3
20	19.7	17.8	13.2	9.2	6.8
22	17.8	16.6	12.4	8.6	6.4
24	15.9	15.2	11.6	8.1	6.0
26	14.5	13.7	11.1	7.7	5.7
28	13.6	12.7	10.6	7.3	5.5
30	12.6	11.3	10.2	7.0	5.3
32	11.8	10.8	9.8	6.6	5.1
34	11.0	10.3	9.4	6.3	4.9
36	10.2	9.6	8.9	6.0	4.7
38	9.3	8.9	8.4	5.7	4.5
40	8.5	8.2	7.8	5.5	4.3
42	7.8	7.5	7.2	5.3	4.1
44	7.3	6.8	6.6	5.2	4.0
46	6.8	6.4	6.0	5.1	3.9
48	6.2	5.9	5.6	4.9	3.8
50	5.7	5.5	5.2	4.8	3.7
55	4.8	4.5	4.3	4.1	3.5
60	4.0	3.8	3.6	3.3	2.9
65	3.4	3.1	3.0	2.8	2.3
70	2.7	2.6	2.4	2.3	
75	2.3	2.1	2.0		

Above lift chart is for reference only. For actual lift duty please refer to lift chart in operator's cab or manual.

L – boom configuration with 62.8 m main boom (No. 2018.xx / No. 1309.xx)

Configuration for L – boom lengths (60.5 m – 98.6 m)											
	Length	Amount of boom and luffing jib extensions									
Boom foot	7.0 m	1	1	1	1	1	1	1	1	1	1
Boom insert	3.0 m	1	1	1	1	1	1	1	1	1	1
Boom insert	6.0 m	1	1	1	1	1	1	1	1	1	1
Boom insert	11.7 m	4	4	4	4	4	4	4	4	4	4
Tapered	7.2 m	1	1	1	1	1	1	1	1	1	1
Luffing insert	3.0 m			1		1		1		1	
Luffing insert	6.0 m		1	1			1	1			1
Luffing insert	11.7 m				1	1	1	1	2	2	2
Luffing jib head	5.5 m	1	1	1	1	1	1	1	1	1	1
Max. L – boom length (m)		78.5	81.5	84.5	87.2	90.2	93.2	96.2	98.9	101.1	104.9

Working range - luffing jib (No. 1309.xx) **78° - 15°**

Main boom **88° - 45°**

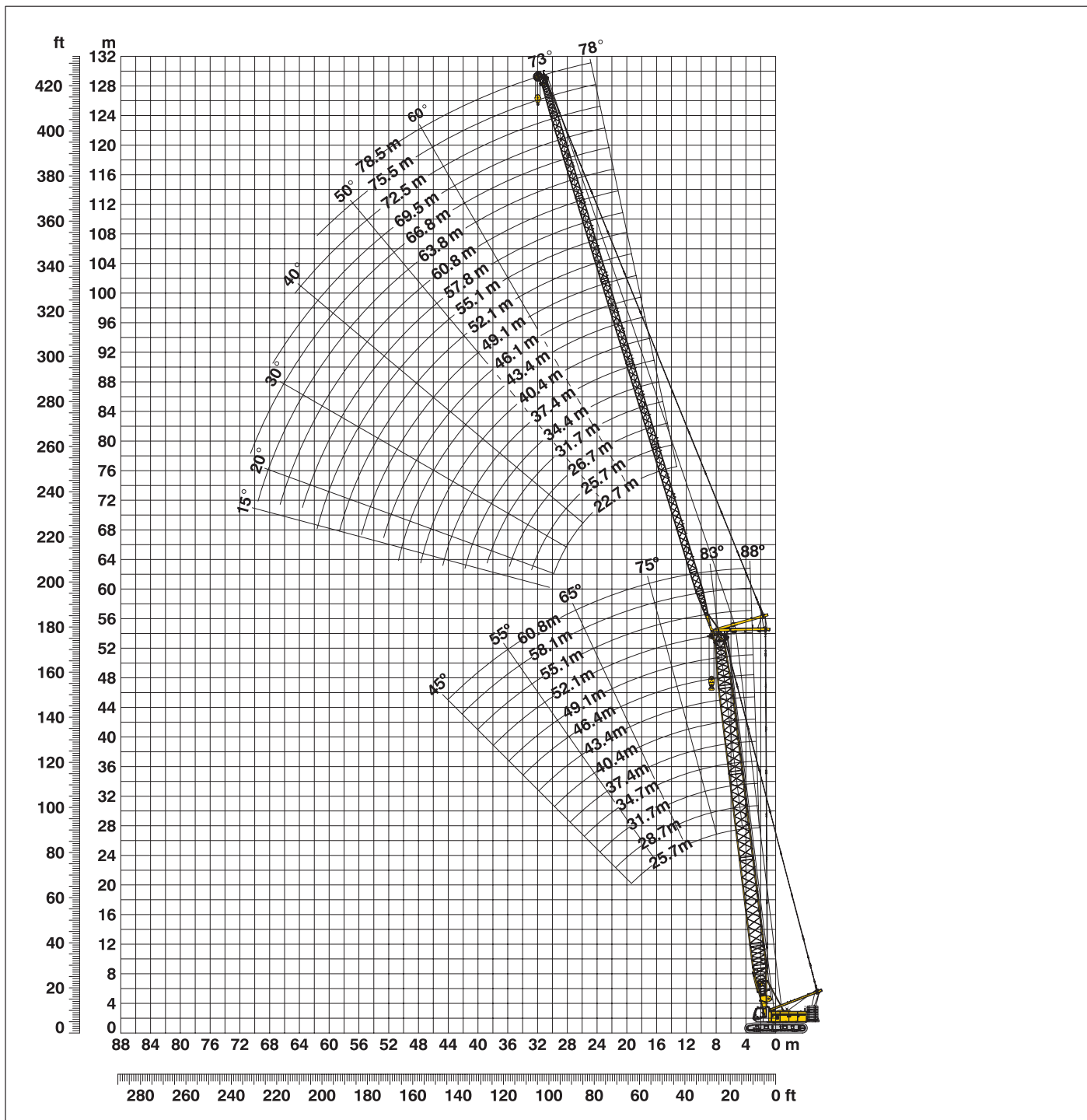

Boom configuration for main boom lengths (25.7 m - 60.8 m) – see table 1 on page 12

Jib configuration for jib lengths (22.7 m - 78.5 m)

	Length	Amount of luffing jib extensions																			
Luffing jib foot	5.5 m	1	1	1	1	1	1	1	1	1	1	1	1	1	1	1	1	1	1	1	
Luffing jib insert	3.0 m		1		1		1		1		1		1		1		1		1		
Luffing jib insert	6.0 m			1	1		1	1		1	1		1	1		1	1		1	1	
Luffing jib insert	11.7 m	1	1	1	1	2	2	2	2	3	3	3	3	4	4	4	4	5	5	5	5
Luffing jib head	5.5 m	1	1	1	1	1	1	1	1	1	1	1	1	1	1	1	1	1	1	1	1
Luffing jib length (m)		22.7	25.7	28.7	31.7	34.4	37.4	40.4	43.4	46.1	49.1	52.1	55.1	57.8	60.8	63.8	66.8	69.5	72.5	75.5	78.5

Lift chart – tower crane (No. 1309.xx)

Main boom angle 88°

Main boom 25.7 m

Radius (m)	Jib length in (m)							
	22.7	28.7	34.4	40.4	49.1	55.1	69.5	78.5
8.4	t	t	t	t	t	t	t	t
10	47.4	35.0						
11	44.2	34.2	27.1					
13	37.9	32.5	26.1	20.4				
14	33.4	31.5	25.5	20.0	13.8			
16	28.9	27.2	24.2	19.1	13.3	10.3		
19	22.2	21.2	20.0	17.4	12.3	9.5	5.1	
20	20.6	19.5	18.8	16.7	12.1	9.3	5.0	3.3
22	17.1	16.4	16.6	15.3	11.1	8.9	4.9	3.2
24	15.4	15.0	14.3	13.9	10.7	8.5	4.7	3.1
30		11.3	10.8	10.2	9.3	7.7	4.4	2.7
36			8.9	8.4	7.6	6.8	4.1	2.5
42				7.0	6.4	5.9	3.8	2.2
50					5.0	4.7	3.2	2.0
55						4.1	2.9	
60							2.5	
65							2.1	

Main boom 37.4 m

Radius (m)	Jib length in (m)							
	22.7	28.7	34.4	40.4	49.1	55.1	69.5	78.5
8.8	t	t	t	t	t	t	t	t
11	39.8	29.9						
12	37.2	29.2	23.3					
13	33.6	29.2	23.3					
15	31.3	28.1	22.8	18.3				
16	26.3	25.3	21.8	17.6	12.4			
19	24.5	22.2	21.4	17.2	12.2	9.4		
22	19.2	18.7	17.7	15.9	11.0	8.9	4.7	
24	15.9	14.7	14.5	13.4	10.3	8.3	4.6	3.1
30	14.4	13.5	12.8	11.8	9.8	7.9	4.5	2.9
36		10.6	10.0	9.0	8.3	7.2	4.2	2.6
42			8.3	7.6	6.6	6.2	3.9	2.4
46				6.4	5.7	5.2	3.6	2.2
48					5.1	4.7	3.4	2.1
50					4.9	4.4	3.3	2.0
55					4.6	4.2	3.1	
60						3.7	2.7	
65							2.2	

Main boom 43.4 m

Radius (m)	Jib length in (m)							
	22.7	28.7	34.4	40.4	49.1	55.1	69.5	78.5
9	t	t	t	t	t	t	t	t
11	34.9	27.4						
12	32.9	27.4						
13	30.3	26.8	21.5					
15	28.1	25.6	21.1	16.9				
16	23.7	22.7	19.9	16.3	11.3			
19	22.3	21.2	19.2	16.0	11.2	8.9		
22	17.8	17.2	16.2	14.9	10.5	8.4	4.4	
26	14.9	13.9	13.5	12.5	9.8	7.9	4.4	3.0
30	11.5	11.3	10.5	10.3	8.8	7.3	4.2	2.8
36		10.1	9.4	8.4	7.8	6.9	4.0	2.6
42			7.9	7.2	6.1	5.8	3.8	2.3
46				6.1	5.3	4.8	3.4	2.1
50					4.8	4.3	3.2	2.0
55					4.3	3.9	2.9	
60						3.4	2.5	

Main boom 52.1 m

Radius (m)	Jib length in (m)							
	22.7	28.7	34.4	40.4	49.1	55.1	69.5	78.5
10	t	t	t	t	t	t	t	t
11	28.3	23.0						
12	27.1	23.0						
13	25.3	22.3	18.6					
15	23.5	21.3	18.3	14.7				
17	20.4	18.9	17.1	14.3	10.1			
20	18.0	16.7	15.5	13.6	9.9	8.0		
22	14.9	13.9	13.0	11.7	9.3	7.5	4.1	
24	13.4	12.2	11.7	10.6	8.9	7.2	4.0	2.8
26	12.2	11.2	10.6	9.5	8.4	6.9	4.0	2.7
32	10.9	10.5	9.5	8.9	7.8	6.6	3.9	2.6
36		8.3	7.8	7.0	6.3	5.7	3.7	2.4
42			6.9	6.3	5.4	5.0	3.5	2.2
48				5.3	4.7	4.2	3.1	2.0
50					4.1	3.6	2.6	
55					3.9	3.4	2.4	
60						3.0	2.0	

Main boom 55.1 m

Radius (m)	Jib length in (m)							
	22.7	28.7	34.4	40.4	49.1	55.1	63.8	69.5
10	t	t	t	t	t	t	t	t
11	26.3	21.4						
12	25.2	21.4						
14	23.1	20.8	17.5					
15	20.7	18.9	16.9	13.9				
17	19.3	17.8	16.2	13.7	9.6			
18	17.1	15.8	14.6	12.9	9.4	7.6		
20	16.0	14.8	13.8	12.4	9.2	7.5	5.2	
22	14.2	13.2	12.3	11.4	8.9	7.2	5.2	3.9
24	12.9	11.3	11.2	10.2	8.5	6.9	5.1	3.9
26	11.3	10.7	10.2	9.0	7.9	6.6	5.0	3.8
32	10.5	10.0	9.1	8.4	7.3	6.3	4.8	3.7
36		7.8	7.5	6.7	5.9	5.3	4.4	3.5
42			6.6	6.1	5.1	4.7	4.0	3.4
50				5.1	4.5	3.9	3.4	3.0
55					3.7	3.2	2.6	2.2

Main boom 60.8 m

Radius (m)	Jib length in (m)				
	22.7	25.7	28.7	31.7	34.4
10	t	t	t	t	t
11	22.2	19.9	18.3		
12	21.3	19.2	17.9	16.7	
13	20.3	19.2	17.9	16.7	
14	19.2	18.3	17.3	16.2	15.3
16	18.2	17.4	16.5	15.6	14.7
18	16.1	15.5	14.8	14.2	13.5
20	14.4	13.8	13.2	12.8	12.3
22	12.8	12.4	11.5	11.3	10.8
24	11.1	11.1	10.5	10.4	9.9
26	10.2	10.2	9.5	9.4	9.0
28	8.8	9.1	8.9	8.5	8.2
32		8.4	8.1	8.0	7.5
34			7.2	7.0	6.7
36				6.7	6.4
38				6.1	5.7

Capacities in metric tons with luffing jib (No. 1309.xx) 55 t counterweight + 15 t carbody counterweight. Above lift chart is for reference only. For actual lift duty and complete chart with all available configurations please refer to lift chart in operator's cab or manual.

Lift chart – luffing jib (No. 1309.xx)

Main boom angle 83°

Main boom 25.7 m

Radius (m)	Jib length in (m)							
	22.7	28.7	34.4	40.4	49.1	55.1	69.5	78.5
12.6	t	t	t	t	t	t	t	t
15	44.2	39.8	32.1					
16	37.8	31.3	24.7					
18	32.4	29.6	24.0	18.7				
22	21.6	21.5	21.2	17.0	11.4			
24	18.7	19.3	19.4	16.1	10.9	8.8		
26	17.1	17.6	17.4	15.1	10.6	8.5		
28		15.8	15.7	14.2	10.4	8.2	4.6	
30		14.3	14.5	13.2	10.1	8.0	4.5	2.8
32		13.1	13.3	12.4	9.8	7.7	4.4	2.7
38			10.3	9.6	8.9	7.0	4.1	2.5
44				7.7	7.9	6.4	3.8	2.2
48					7.1	6.0	3.6	2.1
50					6.7	5.8	3.4	2.1
55						5.1	3.2	
65							2.7	
70							2.4	

Main boom 37.4 m

Radius (m)	Jib length in (m)							
	22.7	28.7	34.4	40.4	49.1	55.1	69.5	78.5
14	t	t	t	t	t	t	t	t
16	36.8	33.6	27.7					
18	30.3	26.4	21.3					
20	26.0	24.4	20.6	16.4				
22	21.8	21.6	19.6	15.8	10.6			
24	19.2	18.6	18.6	15.1	10.4	8.2		
28	15.3	15.0	14.7	13.6	9.8	7.8	4.4	
30		13.7	13.3	12.7	9.6	7.6	4.3	
32		12.7	12.5	11.6	9.3	7.4	4.2	2.7
34		11.4	11.1	11.2	9.0	7.2	4.2	2.6
40			9.3	9.0	8.1	6.6	3.9	2.3
46				7.3	6.9	5.9	3.6	2.1
50					6.2	5.5	3.4	2.0
55						4.9	3.2	
60						4.2	2.9	
65							2.6	
70							2.3	

Main boom 43.4 m

Radius (m)	Jib length in (m)							
	22.7	28.7	34.4	40.4	49.1	55.1	69.5	78.5
15	t	t	t	t	t	t	t	t
17	31.0	24.8						
19	25.5	22.9	19.4					
20	22.6	22.0	19.1	15.2				
24	18.0	17.7	16.7	14.3	9.9			
26	16.0	15.2	15.3	13.7	9.6	7.7		
28	14.7	14.2	13.9	13.0	9.3	7.5		
30		13.1	12.5	12.1	9.1	7.3	4.1	
32		12.1	11.3	10.9	8.9	7.1	4.1	2.6
34		11.2	10.8	10.3	8.6	6.9	4.0	2.5
40			8.9	8.5	7.6	6.4	3.8	2.3
46				7.0	6.5	5.7	3.5	2.1
50					5.8	5.3	3.3	2.0
55					4.9	4.7	3.1	
60						4.0	2.8	
70							2.2	

Main boom 52.1 m

Radius (m)	Jib length in (m)							
	22.7	28.7	34.4	40.4	49.1	55.1	69.5	78.5
16	t	t	t	t	t	t	t	t
18	23.1	19.2						
20	19.6	17.8	15.9					
22	17.7	16.3	14.8	12.8				
24	15.9	15.0	13.8	12.2	8.9			
26	14.5	13.7	12.8	11.3	8.7	7.0		
30	12.4	11.4	10.9	10.2	8.2	6.7	3.8	
34		10.2	9.7	8.9	7.7	6.4	3.7	2.4
36		9.3	9.1	8.4	7.3	6.2	3.7	2.4
40			8.0	7.5	6.6	5.8	3.5	2.2
42			7.4	7.0	6.3	5.6	3.5	2.2
46				6.3	5.7	5.2	3.3	2.0
48				5.8	5.4	4.9	3.2	
55					4.4	4.1	2.8	
60						3.6	2.5	
65							2.2	

Main boom 55.1 m

Radius (m)	Jib length in (m)							
	22.7	28.7	34.4	40.4	49.1	55.1	63.8	69.5
17	t	t	t	t	t	t	t	t
18	20.9	17.5						
20	18.2	16.5	14.6					
22	16.7	15.2	13.7	11.7				
24	15.1	14.0	12.8	11.2	8.5			
26	13.8	13.0	11.8	10.6	8.3	6.7		
30	11.0	11.2	10.4	9.5	7.8	6.4	4.8	3.7
32		10.5	9.7	9.0	7.5	6.3	4.7	3.7
36		9.1	8.7	8.0	6.9	6.0	4.5	3.6
42			7.2	6.7	5.9	5.3	4.2	3.4
48				5.6	5.1	4.6	3.9	3.1
50					4.8	4.4	3.8	3.0
55					4.2	3.8	3.3	2.7
60						3.4	2.8	2.4
65							2.4	2.0
70								2.1

Main boom 60.8 m

Radius (m)	Jib length in (m)					
	22.7	25.7	28.7	31.7	34.4	
17	t	t	t	t	t	
18	17.6	15.9				
19	16.3	15.4	14.4			
20	15.6	14.8	14.0	13.2		
22	14.3	13.6	12.9	12.3	11.4	
24	13.2	12.7	11.6	11.2	10.7	
26	12.3	11.5	11.1	10.5	10.0	
28	11.2	11.0	10.4	10.0	9.5	
30	10.4	10.3	9.9	9.4	9.0	
32	9.0	9.6	9.4	9.0	8.5	
34		8.8	8.8	8.5	8.1	
36			8.3	8.0	7.7	
38				7.6	7.3	
40				7.1	6.9	
42					6.5	

Capacities in metric tons with luffing jib (No. 1309.xx) 55 t counterweight + 15 t carbody counterweight. Above lift chart is for reference only. For actual lift duty and complete chart with all available configurations please refer to lift chart in operator's cab or manual.

Lift chart – luffing jib (No. 1309.xx)

Main boom angle 75°

Main boom 25.7 m

Radius (m)	Jib length in (m)							
	22.7	28.7	34.4	40.4	49.1	55.1	69.5	78.5
19.1	t	t	t	t	t	t	t	t
22	31.2	27.2						
26	22.5	22.2	21.1					
28	20.6	20.4	19.9	16.0				
32		17.3	17.1	14.3	10.4			
34		16.1	15.8	13.4	10.1	7.8		
36		14.8	14.3	12.7	9.9	7.6		
40			12.4	11.2	9.4	7.2	4.1	
42			11.5	10.7	9.1	7.0	4.0	
44				10.2	8.8	6.7	4.0	2.3
46				9.6	8.5	6.5	3.9	2.3
48				8.9	8.2	6.4	3.8	2.2
50					7.8	6.2	3.7	2.1
55					6.9	5.8	3.4	
60						5.1	3.2	
70							2.8	
75							2.6	

Main boom 37.4 m

Radius (m)	Jib length in (m)							
	22.7	28.7	34.4	40.4	49.1	55.1	69.5	78.5
22.2	t	t	t	t	t	t	t	t
26	24.1	20.6	19.8					
28	19.2	18.4	17.8					
30	17.9	17.2	16.6	14.9				
34	15.4	15.2	14.6	13.9	9.6			
36		14.2	13.8	13.2	9.5	7.3		
40		12.0	12.3	11.0	9.1	7.0		
42			11.5	10.4	8.9	6.9	3.9	
44			10.9	9.8	8.7	6.7	3.9	
46				9.2	8.5	6.5	3.8	2.2
48				8.7	8.3	6.3	3.7	2.2
50				8.2	8.1	6.2	3.6	2.1
55					7.4	5.8	3.4	
60						5.4	3.2	
65						4.8	3.0	
70							2.8	
75							2.7	

Main boom 43.4 m

Radius (m)	Jib length in (m)							
	22.7	28.7	34.4	40.4	49.1	55.1	69.5	78.5
24	t	t	t	t	t	t	t	t
28	20.9	17.3						
30	16.8	16.2	15.6					
32	15.8	15.1	14.6	13.7				
34	14.9	14.3	13.7	13.2				
36	12.1	13.5	12.9	12.4	9.0			
38		12.7	12.2	11.5	8.9	6.9		
40		12.0	11.6	11.1	8.7	6.8		
44			10.5	10.0	8.4	6.5	3.7	
46			9.9	9.5	8.3	6.4	3.7	
48				8.9	8.1	6.2	3.6	2.1
50				8.5	7.9	6.1	3.6	2.1
60					6.4	5.4	3.1	
65						4.9	3.0	
75							2.6	
80							2.5	

Main boom 52.1 m

Radius (m)	Jib length in (m)							
	22.7	28.7	34.4	40.4	49.1	55.1	69.5	78.5
26	t	t	t	t	t	t	t	t
30	16.8	13.9						
32	14.3	13.2	12.1					
34	13.4	12.5	11.4	9.9				
38	11.9	11.3	10.4	9.3	7.5			
40		10.8	9.9	8.9	7.3	6.0		
44		9.9	9.2	8.2	6.9	5.8		
46			8.8	7.9	6.7	5.7	3.4	
48			8.5	7.6	6.5	5.6	3.4	
50				7.3	6.3	5.4	3.3	2.0
55				6.7	5.8	5.1	3.2	
60					5.4	4.7	3.0	
65						4.4	2.8	
70							2.6	
75							2.5	
80							2.3	

Main boom 55.1 m

Radius (m)	Jib length in (m)							
	22.7	28.7	34.4	40.4	49.1	55.1	63.8	69.5
28	t	t	t	t	t	t	t	t
30	14.6	12.6						
32	13.1	11.6	10.6					
36	11.6	10.7	9.9	8.7				
38	11.2	10.3	9.4	8.4	6.7			
42		9.6	8.6	7.7	6.4	5.5		
44		9.2	8.3	7.4	6.2	5.4		
46			8.0	7.1	6.0	5.2	4.0	
48			7.8	6.8	5.8	5.1	3.9	3.2
50			7.5	6.5	5.6	4.9	3.9	3.1
55				6.1	5.2	4.6	3.7	3.0
60					4.8	4.3	3.4	2.9
65						4.0	3.2	2.7
70							3.8	3.0
75								2.8
80								2.2

Main boom 60.8 m

Radius (m)	Jib length in (m)				
	22.7	25.7	28.7	31.7	34.4
30	t	t	t	t	t
32	10.9	10.3			
34	10.4	9.9	9.4	8.8	
36	10.0	9.5	9.0	8.6	8.1
38	9.6	9.1	8.6	8.2	7.8
40	9.2	8.7	8.2	7.8	7.5
42	8.8	8.3	7.9	7.5	7.1
44		8.1	7.5	7.2	6.8
46			7.3	6.9	6.6
48			7.1	6.7	6.3
50				6.5	6.1
					5.9

Capacities in metric tons with luffing jib (No. 1309.xx) 55 t counterweight + 15 t carbody counterweight. Above lift chart is for reference only. For actual lift duty and complete chart with all available configurations please refer to lift chart in operator's cab or manual.

Lift chart – luffing jib (No. 1309.xx)

Main boom angle 65°

Main boom 25.7 m

Radius (m)	Jib length in (m)						
	22.7	28.7	34.4	40.4	49.1	55.1	69.5
26.8	t	t	t	t	t	t	t
32	20.4	16.4	16.2				
34	15.2	15.0	14.8				
38		13.1	12.9	12.6			
40		12.2	12.1	11.8			
42			10.4	11.1	9.1		
46			9.1	9.9	8.8	6.8	
48				9.3	8.7	6.7	
50				8.8	8.4	6.5	
55					7.4	6.1	3.5
60					6.5	5.6	3.3
65						5.1	3.1
70							2.9
75							2.8
80							2.7

Main boom 37.4 m

Radius (m)	Jib length in (m)						
	22.7	28.7	34.4	40.4	49.1	55.1	69.5
31.7	t	t	t	t	t	t	t
36	15.1	12.9					
38	12.1	11.9					
40	11.3	11.1	10.9				
42		10.4	10.2	9.7			
46		9.2	9.1	8.8			
48			8.6	8.3	7.7		
50			8.1	7.9	7.4		
55				6.9	6.5	6.1	
60					5.7	5.4	3.3
65					5.0	4.8	3.1
70						4.2	3.0
75							2.8
80							2.7
85							2.3

Main boom 43.4 m

Radius (m)	Jib length in (m)						
	22.7	28.7	34.4	40.4	49.1	55.1	69.5
34.3	t	t	t	t	t	t	t
38	12.7	10.8					
40	11.4	10.3					
42	10.7	10.3					
46	10.0	9.7	9.3				
48		8.7	8.4	7.9			
50		8.2	8.0	7.5			
55			7.5	7.2	6.5		
65				6.3	5.7	5.3	
70					4.6	4.2	3.1
75						3.7	2.8
80							2.4
							2.1

Main boom 52.1 m

Radius (m)	Jib length in (m)						
	22.7	28.7	34.4	40.4	49.1	55.1	69.5
38	t	t	t	t	t	t	t
40	9.7						
42	9.2						
44	8.7	8.2					
46	8.3	7.8					
48	7.9	7.4	7.0				
50		7.0	6.6				
55		6.7	6.3	5.9			
60			5.6	5.2	4.6		
65				4.6	4.0	3.6	
70					3.5	3.1	2.3
75					3.1	2.7	
						2.4	

Main boom 55.1 m

Radius (m)	Jib length in (m)						
	22.7	28.7	34.4	40.4	49.1	55.1	63.8
40	t	t	t	t	t	t	t
44	8.6						
46	7.8	7.3					
48	7.4	6.9	6.5				
50	7.0	6.6	6.2				
55		6.3	5.9	5.4			
60			5.2	4.8	4.2		
65				4.2	3.6	3.2	
70				3.7	3.2	2.8	2.3
75					2.8	2.4	
						2.1	

Main boom 60.8 m

Radius (m)	Jib length in (m)				
	22.7	25.7	28.7	31.7	34.4
42	t	t	t	t	t
44	7.1				
46	6.8	6.5			
48	6.4	6.2	6.0		
50	6.1	5.9	5.7	5.4	
55	5.8	5.6	5.4	5.1	5.0
60			4.7	4.5	4.4
					3.9

Capacities in metric tons with luffing jib (No. 1309.xx) 55.0 t counterweight + 15 t carbody counterweight. Above lift chart is for reference only. For actual lift duty and complete chart with all available configurations please refer to lift chart in operator's cab or manual.

Lift chart – luffing jib (No. 1309.xx)

Main boom angle 45°

Main boom 25.7 m

Radius (m)	Jib length in (m)							
	22.7	28.7	34.4	40.4	49.1	55.1	69.5	78.5
39.5	t	t	t	t	t	t	t	t
42	11.1							
46	10.3							
48		9.0						
50		8.5						
55			7.8					
60				6.6				
65				5.8				
70					4.8			
80						4.0		
85							2.5	
							2.1	

Main boom 37.4 m

Radius (m)	Jib length in (m)							
	22.7	28.7	34.4	40.4	49.1	55.1		
47.8	t	t	t	t	t	t		
48	7.1							
50	7.1							
55	6.7							
60		5.6						
65			4.7					
70				3.9				
75					3.0			
					2.6	2.3		

Main boom 43.4 m

Radius (m)	Jib length in (m)							
	22.7	28.7	34.4	40.4				
52.1	t	t	t	t				
55	5.4							
60	5.0							
65		4.1						
70			3.4					
				2.7				

Main boom 52.1 m

Radius (m)	Jib length in (m)							
	22.7	28.7						
60	t	t						
65	3.2							
		2.4						

Capacities in metric tons with luffing jib (No. 1309.xx) 55 t counterweight + 15 t carbody counterweight. Above lift chart is for reference only. For actual lift duty and complete chart with all available configurations please refer to lift chart in operator's cab or manual.

Working range - luffing jib (No. 1713.xx) **78° - 15°**

Main boom **88° - 45°**

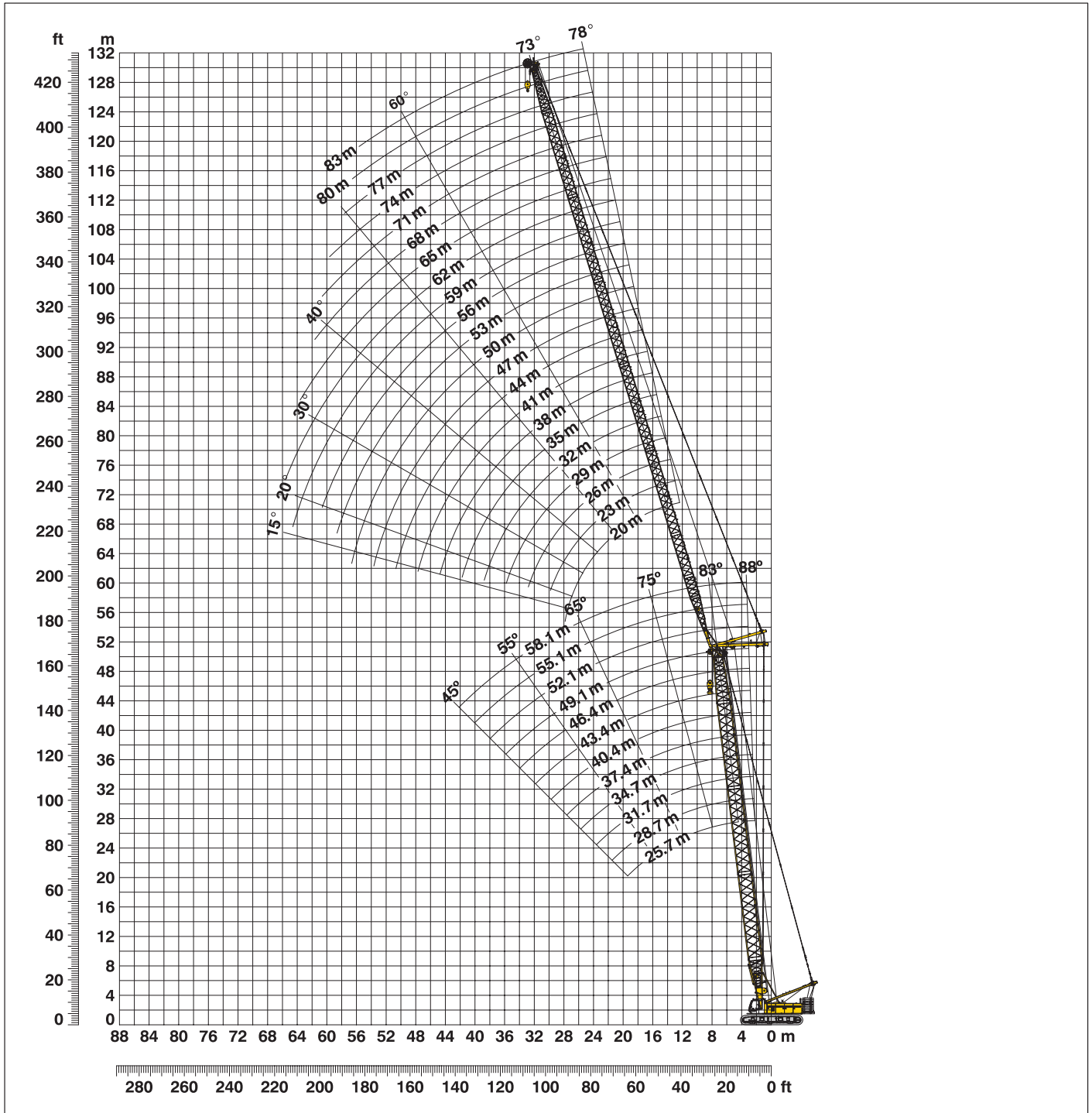

Boom configuration for main boom lengths (25.7 m - 58.1 m) – see table 1 on page 12

Jib configuration for jib lengths (20 m - 83 m)

	Length	Amount of luffing jib extensions																					
Luffing jib foot	7.0 m	1	1	1	1	1	1	1	1	1	1	1	1	1	1	1	1	1	1	1	1		
Luffing jib insert	3.0 m		1		1		1		1		1		1		1		1		1		1		
Luffing jib insert	6.0 m	1	1		1	1		1	1		1	1		1	1		1	1		1	1		
Luffing jib insert	12.0 m			1	1	1	2	2	2	2	3	3	3	3	4	4	4	4	5	5	5	5	
Luffing jib head	7.0 m	1	1	1	1	1	1	1	1	1	1	1	1	1	1	1	1	1	1	1	1	1	
Luffing jib length (m)		20	23	26	29	32	35	38	41	44	47	50	53	56	59	62	65	68	71	74	77	80	83

Lift chart – tower crane (No. 1713.xx)

Main boom angle 88°

Main boom 25.7 m

Radius (m)	Jib length in (m)							
	23	29	35	41	50	56	71	83
9	53.2	t	t	t	t	t	t	t
10	49.5	43.5						
11	44.5	41.5	35.1					
13	37.4	33.9	32.9	28.2				
15	30.4	29.7	28.5	26.5	20.2			
16	28.2	27.1	26.0	25.0	19.8	16.5		
19	21.8	21.0	19.7	20.0	17.7	15.6	9.1	
22	16.8	16.5	16.1	15.7	14.8	13.6	8.7	5.8
24	15.1	14.9	14.1	13.5	13.4	12.3	8.3	5.6
30		10.7	10.2	9.8	9.2	8.7	7.4	5.1
36			7.8	7.7	6.8	6.6	5.6	4.5
42				6.1	5.4	5.0	4.3	3.7
44					4.8	4.6	4.0	3.4
46					4.5	4.3	3.6	3.1
48					4.2	3.9	3.2	2.8
50					4.0	3.5	2.9	2.5
55						3.0	2.3	

Main boom 37.4 m

Radius (m)	Jib length in (m)							
	23	29	35	41	50	56	71	83
8.9	42.3							
11	37.0	34.5						
12	33.3	31.7	28.4					
13	31.0	29.3	27.0	23.3				
15	26.2	24.8	22.7	21.8	17.2			
16	24.4	22.0	21.4	20.7	17.2	14.0		
19	18.8	18.1	17.4	16.5	15.3	13.3	7.9	
22	15.4	14.3	14.0	13.4	12.2	11.1	7.6	5.0
24	13.8	13.0	12.4	11.6	11.0	10.1	7.3	4.9
26	11.8	11.0	10.6	10.6	9.9	9.2	6.9	4.8
32		8.8	8.3	7.9	7.3	6.7	5.7	4.4
36			7.2	6.7	6.0	5.8	4.7	4.0
42				5.4	4.9	4.5	3.6	2.9
46					4.1	3.9	3.0	2.3
48					3.9	3.5	2.6	2.1
50					3.7	3.2	2.4	
55						2.7		

Main boom 43.4 m

Radius (m)	Jib length in (m)							
	23	29	35	41	50	56	71	83
9.1	36.4	t	t	t	t	t	t	t
11	32.8	29.9						
12	30.2	28.0	24.9					
13	27.9	26.1	24.0	20.5				
15	23.3	22.4	21.1	19.3	15.5			
16	22.1	20.9	19.6	18.3	15.5	12.7		
20	16.5	15.7	14.7	13.9	12.7	11.7	7.2	
22	14.4	13.5	12.9	12.2	11.0	10.5	7.0	4.6
24	12.8	12.1	10.9	10.6	10.1	9.1	6.7	4.6
26	11.4	10.8	10.0	9.8	9.0	8.2	6.3	4.4
32		8.5	7.9	7.4	6.8	6.1	5.0	3.9
38			6.3	5.7	5.2	4.8	3.7	3.1
42				5.2	4.6	4.1	3.2	2.5
44					4.2	3.9	2.9	2.2
50					3.5	3.0	2.1	
55						2.6		

Main boom 49.1 m

Radius (m)	Jib length in (m)							
	23	29	35	41	50	56	71	83
9.3	31.1	t	t	t	t	t	t	t
11	28.9	25.8						
12	26.8	24.7	21.3					
13	24.9	23.1	20.8	17.8				
15	21.2	20.0	18.7	17.0	13.7			
17	18.7	17.5	16.2	15.2	13.2	11.1		
20	15.2	14.4	13.4	12.5	11.3	10.2	6.4	
22	13.4	12.6	11.7	10.8	10.0	9.2	6.3	4.1
26	10.9	10.3	9.5	8.9	8.1	7.3	5.7	4.0
32		8.0	7.4	6.8	6.1	5.5	4.3	3.4
38			6.0	5.4	4.8	4.4	3.3	2.6
42				4.9	4.2	3.8	2.8	2.0
44				4.5	3.9	3.5	2.5	
48					3.5	3.0	2.0	
50					3.3	2.8		
55						2.4		

Main boom 55.1 m

Radius (m)	Jib length in (m)					
	23	29	35	41	50	56
9.5	24.0	t	t	t	t	t
11	24.0	21.7				
12	23.0	21.0	18.1			
14	20.4	18.8	17.2	15.2		
16	17.8	16.6	15.3	14.0	11.4	
17	16.8	15.6	14.3	13.3	11.2	9.5
18	15.7	14.5	13.5	12.5	10.8	9.5
20	13.8	12.9	11.3	11.1	9.8	8.8
22	12.4	10.9	10.6	9.9	8.7	7.9
24	11.0	10.2	9.6	8.7	7.8	7.0
26	10.2	9.4	8.6	8.0	7.1	6.3
32		7.4	6.7	6.1	5.4	4.9
38			5.5	4.9	4.3	3.9
44				4.2	3.6	3.2
50					3.0	2.5
55						2.1

Main boom 58.1 m

Radius (m)	Jib length in (m)				
	29	32	35	38	41
10.8	19.9	t	t	t	t
12	19.4	18.3			
13	18.6	17.6	16.7	15.3	
14	17.5	16.8	15.9	15.0	14.0
16	15.5	14.9	14.3	13.8	13.0
18	13.7	13.2	12.6	12.2	11.4
20	12.2	11.5	10.9	10.9	10.4
24	9.6	9.3	9.1	8.6	8.1
28	8.1	7.8	7.4	7.2	6.8
30	7.5	7.2	6.9	6.6	6.3
32	7.0	6.6	6.4	6.2	5.8
34		6.2	5.9	5.7	5.5
38			5.2	5.0	4.7
40				4.8	4.5
42					4.3
44					4.0

Capacities in metric tons with luffing jib (No. 1713.xx) 55 t counterweight + 15 t carbody counterweight. Above lift chart is for reference only. For actual lift duty and complete chart with all available configurations please refer to lift chart in operator's cab or manual.

Lift chart – luffing jib (No. 1713.xx)

Main boom angle 83°

Main boom 25.7 m

Radius (m)	Jib length in (m)							
	23	29	35	41	50	56	71	83
13	t	t	t	t	t	t	t	t
15	46.3	37.8						
17	35.1	33.4	30.7					
18	32.4	31.3	29.2	25.1				
22	21.7	21.6	22.0	22.0	17.8			
24	18.9	19.3	19.8	19.7	17.0	14.2		
28	12.1	15.3	14.8	15.7	14.9	13.3	8.0	
32		12.3	12.5	12.3	12.6	11.8	7.6	5.1
38			9.1	9.3	9.1	9.4	6.9	4.7
42				7.9	7.7	7.5	6.3	4.5
44				7.3	6.9	6.9	5.9	4.4
46					6.1	6.3	5.6	4.2
48					5.6	5.7	5.2	4.0
50					5.2	5.1	4.8	3.8
55						4.1	3.9	3.3
60						3.1	3.0	2.7
65							2.1	2.0

Main boom 37.4 m

Radius (m)	Jib length in (m)							
	23	29	35	41	50	56	71	83
14.1	t	t	t	t	t	t	t	t
16	36.6	30.1						
18	29.3	27.8	24.9					
20	25.0	24.4	22.9	20.4				
22	21.0	21.0	20.5	19.1	15.0			
24	18.4	18.1	17.7	17.5	14.7	11.9		
30		13.0	12.5	12.8	12.2	11.2	7.0	
32		11.5	11.0	10.9	11.0	10.6	6.9	4.6
34		10.7	10.3	10.3	10.1	10.0	6.7	4.6
40			8.2	7.8	7.6	7.6	6.1	4.3
42				7.2	7.1	6.8	5.9	4.1
44				6.9	6.5	6.2	5.5	4.0
46				6.4	5.9	5.8	5.1	3.9
48					5.3	5.3	4.7	3.7
50					5.0	4.9	4.3	3.5
55					4.1	3.9	3.4	2.9
60						3.2	2.7	2.2

Main boom 43.4 m

Radius (m)	Jib length in (m)							
	23	29	35	41	50	56	71	83
14.8	t	t	t	t	t	t	t	t
17	30.6	25.2						
19	24.9	23.0	20.8					
22	19.6	19.2	18.3	16.6				
24	17.3	17.0	16.3	15.3	13.3			
26	15.1	14.7	14.7	14.0	12.5	10.8		
30	11.8	12.2	11.7	11.2	11.0	9.9	6.4	
34		10.4	10.1	9.6	9.4	8.8	6.2	4.2
36		9.4	9.1	8.9	8.6	8.2	6.0	4.1
40			7.9	7.5	7.0	6.9	5.6	4.0
44				6.5	6.1	5.6	5.1	3.7
46				6.0	5.6	5.3	4.7	3.6
48					5.1	4.9	4.3	3.5
50					4.7	4.6	3.9	3.3
55					4.0	3.7	3.0	2.6
60						3.1	2.4	

Main boom 49.1 m

Radius (m)	Jib length in (m)							
	23	29	35	41	50	56	71	83
15.5	t	t	t	t	t	t	t	t
18	25.7	20.9						
20	20.7	19.0	17.3					
22	18.3	17.3	15.9	14.4				
24	16.2	15.6	14.6	13.3	11.0			
26	14.5	13.9	13.3	12.4	10.6	9.2		
30	11.6	11.2	10.8	10.8	9.3	8.5	5.7	
34		9.8	9.4	8.9	7.8	7.6	5.4	3.7
36		9.1	8.6	8.2	7.3	7.2	5.2	3.7
42			6.9	6.4	5.9	5.7	4.5	3.2
44				6.0	5.6	5.1	4.3	3.1
46				5.7	5.2	4.8	4.0	3.0
48				5.2	4.8	4.5	3.7	2.8
50					4.4	4.2	3.4	2.6
55					3.8	3.4	2.6	2.1
60						2.9	2.1	

Main boom 55.1 m

Radius (m)	Jib length in (m)					
	23	29	35	41	50	56
16.3	t	t	t	t	t	t
18	20.9	17.3				
20	17.8	16.2	14.4			
22	16.3	14.8	13.4	11.6		
26	13.4	12.5	11.4	10.4	8.8	7.5
28	11.9	11.5	10.7	9.8	8.4	7.3
30	11.3	10.7	9.9	9.2	7.9	6.9
36		8.5	7.9	7.3	6.7	6.0
40			6.8	6.4	5.7	5.3
42			6.4	5.9	5.3	4.9
44				5.5	5.0	4.5
46				5.2	4.7	4.2
48				4.9	4.3	4.0
50					4.0	3.7
55					3.5	3.0
60						2.6

Main boom 58.1 m

Radius (m)	Jib length in (m)					
	29	32	35	38	41	
18.4	t	t	t	t	t	
20	15.6	14.1				
22	13.6	12.9	12.3	11.4	10.5	
24	12.6	11.6	11.2	10.7	10.1	
26	11.5	11.0	10.5	10.0	9.4	
28	10.8	10.4	9.8	9.4	8.9	
30	10.1	9.7	9.2	8.9	8.4	
32	9.3	9.1	8.6	8.3	7.9	
34	8.5	8.4	8.1	7.7	7.4	
36	8.0	7.6	7.5	7.3	6.9	
38		7.2	6.8	6.8	6.5	
40		6.7	6.4	6.2	6.0	
42			6.1	5.8	5.6	
44				5.5	5.2	
46				5.1	4.9	
48					4.7	

Capacities in metric tons with luffing jib (No. 1713.xx) 55 t counterweight + 15 t carbody counterweight. Above lift chart is for reference only. For actual lift duty and complete chart with all available configurations please refer to lift chart in operator's cab or manual.

Lift chart – luffing jib (No. 1713.xx)

Main boom angle 75°

Main boom 25.7 m

Radius (m)	Jib length in (m)							
	23	29	35	41	50	56	71	83
20	t	t	t	t	t	t	t	t
22	29.1	26.4	25.4					
26	22.0	21.5	20.6					
28	20.0	19.8	19.1	18.4				
30	18.3	18.2	17.8	17.1				
32		16.7	16.5	16.0	15.0			
34		15.5	15.2	14.6	13.7	12.6		
36		13.9	13.9	13.1	12.4	12.0		
40			11.3	11.1	10.7	10.4	6.9	
42			10.4	10.5	10.0	9.6	6.9	
46				9.1	8.7	8.0	6.4	4.4
48				8.3	8.0	7.5	6.0	4.3
55					6.1	5.6	4.7	3.9
60						4.8	4.0	3.3
70							2.8	2.2
75							2.2	

Main boom 37.4 m

Radius (m)	Jib length in (m)							
	23	29	35	41	50	56	71	83
22.3	t	t	t	t	t	t	t	t
26	23.1	19.8	19.0					
28	18.4	17.7	16.9					
30	17.1	16.5	15.7	15.1				
34	14.8	14.4	13.8	13.2	12.3			
38		12.7	12.2	11.7	10.9	10.3		
40		11.7	11.6	11.0	10.2	9.7		
44			10.2	9.9	9.1	8.6	6.2	
46			9.5	9.4	8.6	8.1	6.1	
48				8.8	8.2	7.7	6.0	3.9
50				8.3	7.8	7.3	5.8	3.9
55					6.8	6.4	5.1	3.7
60					5.4	5.3	4.4	3.4
65						4.4	3.8	3.0
70							3.1	2.5
75							2.5	2.1

Main boom 43.4 m

Radius (m)	Jib length in (m)							
	23	29	35	41	50	56	71	83
23.8	t	t	t	t	t	t	t	t
28	20.2	17.2	16.5					
30	16.0	15.4	14.6					
32	15.0	14.4	13.7	13.1				
36	12.1	12.7	12.1	11.5	10.7			
38		12.0	11.4	10.8	10.0	9.1		
42		10.7	10.2	9.7	8.9	8.4		
46			9.2	8.7	8.0	7.4	5.4	
48				8.2	7.5	7.0	5.4	
50				7.8	7.1	6.6	5.2	3.5
55					6.3	5.8	4.6	3.4
60					5.6	5.1	4.0	3.1
65						4.5	3.4	2.6
70							2.9	2.1
75							2.4	
80							2.0	

Main boom 49.1 m

Radius (m)	Jib length in (m)							
	23	29	35	41	50	56	71	83
25.3	t	t	t	t	t	t	t	t
28	17.8	15.4						
32	14.0	13.4	12.7					
34	13.1	12.5	11.8	10.8				
36	12.4	11.8	11.2	10.4				
38		11.2	10.6	9.9	8.5			
40		10.5	10.0	9.4	8.2	7.2		
42		10.0	9.4	8.9	7.8	7.0		
46			8.5	8.0	7.2	6.4	4.4	
48			8.1	7.6	6.8	6.2	4.4	
50				7.2	6.5	5.9	4.2	
55				6.3	5.7	5.2	3.8	2.6
60					5.0	4.6	3.4	2.3
65						4.0	2.9	2.0
70							2.4	
75							2.0	

Main boom 55.1 m

Radius (m)	Jib length in (m)					
	23	29	35	41	50	56
26.9	t	t	t	t	t	t
30	14.4	12.1				
32	12.6	11.1	9.9			
36	11.2	10.2	9.2	8.3		
38	10.8	9.7	8.8	7.9		
40		9.2	8.3	7.6	6.4	
42		8.9	8.0	7.2	6.1	5.3
44		8.6	7.6	6.8	5.7	5.2
48			7.1	6.3	5.3	4.8
50			6.8	6.0	5.1	4.6
55				5.6	4.6	4.1
60					4.2	3.7
65					3.8	3.3
70						3.0

Main boom 58.1 m

Radius (m)	Jib length in (m)				
	29	32	35	38	41
30.2	t	t	t	t	t
32	10.2	9.4			
34	9.5	9.0	8.5	7.9	
36	9.1	8.6	8.1	7.7	7.1
38	8.6	8.2	7.7	7.4	6.9
40	8.2	7.8	7.4	7.0	6.5
42	7.8	7.5	7.0	6.7	6.2
44	7.6	7.0	6.7	6.4	5.9
46		6.9	6.3	6.1	5.7
48		6.6	6.1	5.8	5.5
50			6.0	5.6	5.2
55					4.8

Capacities in metric tons with luffing jib (No. 1713.xx) 55 t counterweight + 15 t carbody counterweight. Above lift chart is for reference only. For actual lift duty and complete chart with all available configurations please refer to lift chart in operator's cab or manual.

Lift chart – luffing jib (No. 1713.xx)

Main boom angle 65°

Main boom 25.7 m

Radius (m)	Jib length in (m)							
	23	29	35	41	50	56	71	83
26.9	t	t	t	t	t	t	t	t
32	19.6	15.8						
34	14.6	14.4	14.1					
36		13.4	13.1					
38		12.5	12.2	11.9				
40		11.7	11.4	11.1				
44			10.0	9.8	9.4			
46			9.4	9.2	8.8	8.4		
50				8.1	7.8	7.5		
55					6.7	6.4	5.1	
60					5.8	5.5	4.5	
65						4.8	3.8	3.1
70							3.2	2.6
75							2.8	2.2
80							2.4	

Main boom 37.4 m

Radius (m)	Jib length in (m)							
	23	29	35	41	50	56	71	83
31.9	t	t	t	t	t	t	t	t
32	14.2							
34	14.1							
36	13.2							
38	12.3	11.9						
40	11.4	11.2						
42	10.7	10.4	9.9					
44		9.8	9.4					
46		9.2	8.9	8.4				
48		8.6	8.3	7.9				
50			7.8	7.5	6.8			
55				7.4	7.1	6.4		
60					6.1	5.6	5.1	
65						4.9	4.4	3.3
70						4.3	3.9	2.8
							3.4	2.3

Main boom 43.4 m

Radius (m)	Jib length in (m)							
	23	29	35	41	50	56	71	
34.4	t	t	t	t	t	t	t	
38	11.7							
42	10.6	9.9						
44	9.3	8.9	8.3					
46		8.4	7.9					
48		8.0	7.4	7.0				
50		7.5	7.1	6.6				
55			6.7	6.2	5.5			
60			5.8	5.4	4.8	4.3		
65				4.8	4.2	3.7		
70					3.6	3.2	2.0	
75						2.7		
						2.3		

Main boom 49.1 m

Radius (m)	Jib length in (m)							
	23	29	35	41	50	56		
36.8	t	t	t	t	t	t		
38	9.7							
40	9.4							
42	8.9							
44	8.4	7.9						
46	8.0	7.5	6.9					
48		7.1	6.5					
50		6.7	6.2	5.7				
55		6.4	5.8	5.4				
60			5.1	4.7	4.0			
65				4.1	3.4	3.0		
70					2.9	2.5		
					2.5	2.1		

Main boom 55.1 m

Radius (m)	Jib length in (m)							
	23	29	35	41	50	56		
39.4	t	t	t	t	t	t		
42	7.8							
44	7.3							
46	6.9	6.4						
48	6.5	6.0						
50	6.2	5.7	5.2					
55		5.4	4.9	4.4				
60			4.2	3.8	3.1			
65			3.7	3.3	2.6	2.2		
				2.8	2.2			

Main boom 58.1 m

Radius (m)	Jib length in (m)							
	29	32	35	38	41			
44.1	t	t	t	t	t			
46	5.8							
48	5.5	5.3						
50	5.2	5.0	4.7					
55	4.9	4.7	4.4	4.2				
60	4.3	4.1	3.8	3.6	3.3			
65			3.3	3.1	2.8			
					2.4			

Capacities in metric tons with luffing jib (No. 1713.xx) 55 t counterweight + 15 t carbody counterweight. Above lift chart is for reference only. For actual lift duty and complete chart with all available configurations please refer to lift chart in operator's cab or manual.

Lift chart – luffing jib (No. 1713.xx)

Main boom angle 45°

Main boom 25.7 m

Radius (m)	Jib length in (m)								
	23	29	35	41	50	56			
39.8	t	t	t	t	t	t			
40	10.3								
42	10.3								
46	9.6								
48		8.3							
50		7.8							
55			7.0						
60				5.8					
65				5.0					
70					4.0				
75						3.1			
						2.6			

Main boom 37.4 m

Radius (m)	Jib length in (m)								
	23	29	35	41					
48.1	t	t	t	t					
50	6.3								
55	6.0								
60		4.9							
65			3.9						
				3.0					

Main boom 43.4 m

Radius (m)	Jib length in (m)								
	23	29	35						
52.3	t	t	t						
55	4.6								
60	4.3								
65		3.4							
			2.6						

Main boom 49.1 m

Radius (m)	Jib length in (m)								
	23	29							
56.3	t	t							
65	3.2								
		2.1							

Capacities in metric tons with luffing jib (No. 1713.xx) 55 t counterweight + 15 t carbody counterweight. Above lift chart is for reference only. For actual lift duty and complete chart with all available configurations please refer to lift chart in operator's cab or manual.

Working range - fixed jib (No. 0806.xx) 15° and 30°

Main boom 88°- 30°

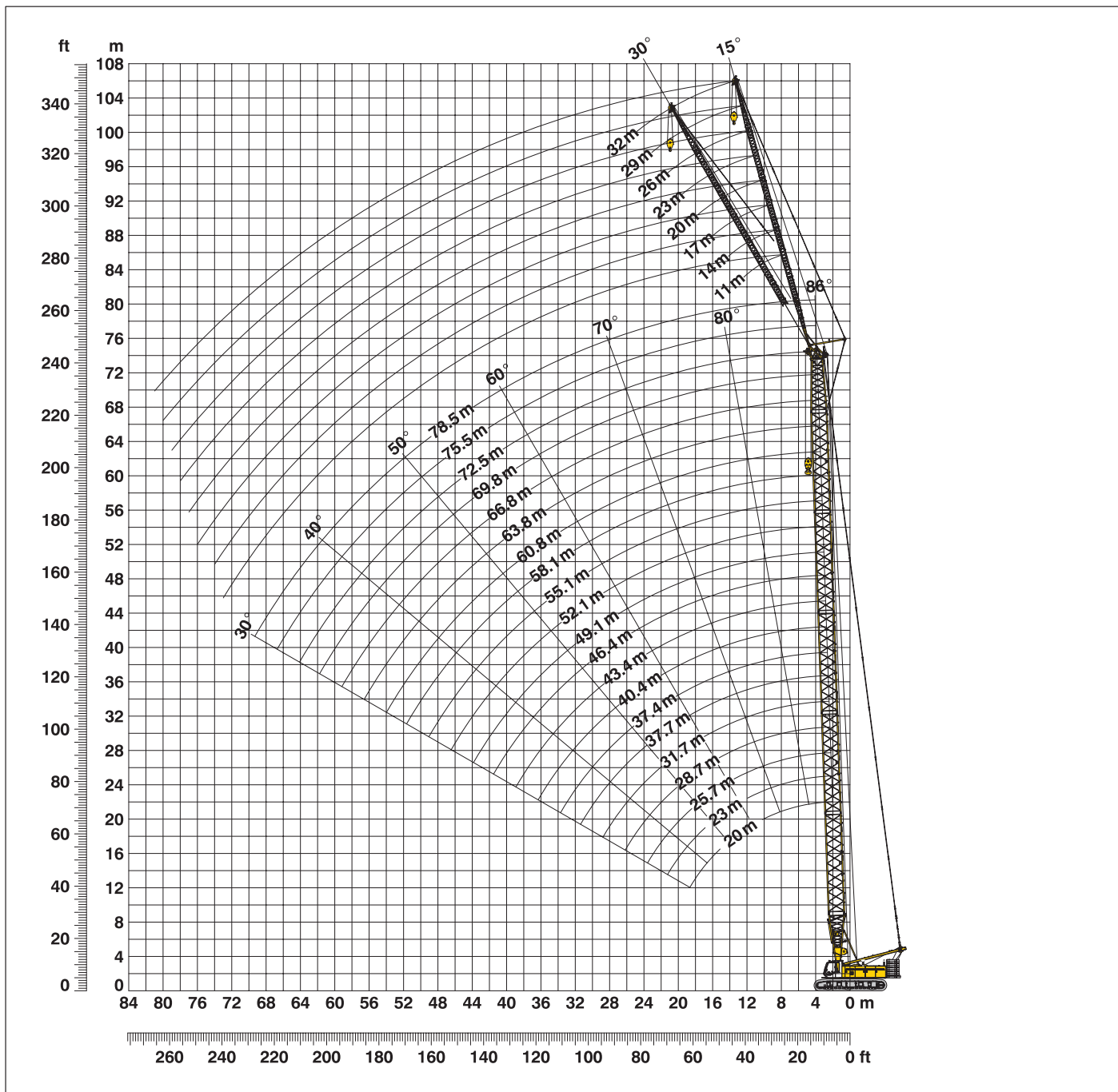

Boom configuration for boom lengths (20 m - 78.5 m) – see table 1 on page 12

Fixed jib configuration for fixed jib lengths (11 m - 32 m)

	Length	Amount of fixed jib extensions							
Fixed jib foot	5.5 m	1	1	1	1	1	1	1	1
Fixed jib insert	3.0 m		1		1		1		1
Fixed jib insert	6.0 m			1	1	2	2	3	3
Fixed jib head	5.5 m	1	1	1	1	1	1	1	1
Fixed jib length (m)		11	14	17	20	23	26	29	32

Lift chart – fixed jib (No. 0806.xx)

Offset 15°

Main boom 20 m

Radius (m)	Fixed jib length in (m)			
	11	20	26	32
5.6	t	t	t	t
10	24.0	14.6		
12	23.8	13.8	12.1	
15	23.1	12.7	12.1	4.5
16	22.6	12.3	12.1	4.4
20	20.6	12.1	11.8	4.1
22	19.6	12.1	11.2	3.9
26	17.5	12.1	10.2	3.7
30	15.2	12.1	10.2	3.5
38		11.2	8.7	3.2
44			7.7	3.1
50				3.1

Main boom 28.7 m

Radius (m)	Fixed jib length in (m)			
	11	20	26	32
5.9	t	t	t	t
10	24.0	14.8		
13	24.0	13.7	12.1	
15	23.3	13.1	12.1	4.5
18	22.2	12.2	12.1	4.3
26	19.3	12.1	11.3	3.8
30	18.1	12.1	10.8	3.6
34	15.3	12.1	10.5	3.5
38	12.1	12.1	9.9	3.3
46		9.3	8.4	3.2
50			7.9	3.1
55				3.1

Main boom 40.4 m

Radius (m)	Fixed jib length in (m)			
	11	20	26	32
6.3	t	t	t	t
11	24.0	14.0		
13	23.7	13.5	12.1	
16	23.1	12.7	12.1	4.4
22	20.8	12.1	12.1	4.0
30	17.7	12.1	11.6	3.7
38	12.6	12.0	10.6	3.4
46	8.2	8.7	9.0	3.2
48	8.7	8.1	8.3	3.2
55		7.4	6.4	3.1
60			5.3	3.0
65				2.9

Main boom 52.1 m

Radius (m)	Fixed jib length in (m)			
	11	20	26	32
6.7	t	t	t	t
11	23.8	13.4		
13	23.4	13.0	12.1	
16	22.2	12.3	12.1	4.3
24	19.6	12.1	11.9	3.9
32	15.6	12.1	11.3	3.6
40	11.1	10.5	10.3	3.3
55	6.3	5.6	5.8	3.1
60		4.5	4.7	3.0
65		3.5	3.8	3.0
70			4.3	2.9
75				2.9

Main boom 58.1 m

Radius (m)	Fixed jib length in (m)			
	11	20	26	32
6.9	t	t	t	t
11	23.4	13.0		
14	22.1	12.5	12.1	
16	21.4	12.1	12.1	4.3
24	19.0	12.1	11.8	3.8
32	15.0	12.1	11.0	3.6
40	10.8	10.0	10.1	3.4
55	4.8	5.2	5.5	3.1
60	4.9	4.1	4.4	3.0
70		2.4	2.6	2.9
75			3.3	2.9
80				2.8

Main boom 66.8 m

Radius (m)	Fixed jib length in (m)			
	11	20	26	32
7.2	t	t	t	t
11	22.7	12.1		
14	21.5	12.1	12.1	
16	20.3	12.1	12.1	4.2
20	19.6	12.1	12.1	4.2
24	18.1	12.1	11.6	4.0
28	16.3	12.0	10.6	3.7
36	10.6	10.9	9.8	3.5
44	8.7	7.7	7.8	3.3
55	5.5	6.1	4.8	3.1
70	2.8	3.3	3.6	2.9
75		2.6	2.9	2.9
80			2.3	2.5

Main boom 72.5 m

Radius (m)	Fixed jib length in (m)			
	11	20	26	32
7.4	t	t	t	t
12	21.0	10.5		
14	18.7	10.3	6.5	
17	17.6	9.8	6.3	4.1
20	16.6	9.3	6.0	4.0
28	14.9	8.4	5.5	3.6
36	10.0	8.0	5.2	3.4
44	6.9	7.4	4.9	3.3
55	5.2	5.7	4.5	3.1
70	2.5	3.0	3.3	2.9
75		2.3	2.6	2.9
80				2.2

Main boom 75.5 m

Radius (m)	Fixed jib length in (m)			
	11	20	26	29
7.5	t	t	t	t
12	19.8	10.5		
14	17.8	10.2	6.4	
16	17.2	9.9	6.3	5.0
24	14.1	8.8	5.6	4.5
32	12.8	8.1	5.2	4.2
40	9.3	7.7	5.0	4.0
48	6.7	7.0	4.7	3.9
55	5.0	5.5	4.6	3.7
65	3.1	3.6	3.9	3.5
70	2.3	2.8	3.1	3.2
75		2.1	2.4	2.5

Main boom 78.5 m

Radius (m)	Fixed jib length in (m)			
	11	14	17	20
7.6	t	t	t	t
9	18.8	15.7		
11	18.3	15.1	13.1	
12	16.6	14.6	12.9	10.0
16	16.3	14.6	12.1	9.5
20	15.6	13.6	12.1	9.5
28	14.3	12.8	10.8	8.9
36	12.3	10.5	9.7	8.0
44	8.9	9.2	9.2	7.6
55	7.6	7.8	8.0	7.1
55	4.8	4.9	5.1	5.2
65	2.9	3.1	3.2	3.4
70	2.1	2.3	2.5	2.6

Capacities in metric tons with fixed jib (No. 0806.xx) 55 t counterweight + 15 t carbody counterweight. Above lift chart is for reference only. For actual lift duty and complete chart with all available configurations please refer to lift chart in operator's cab or manual.

Lift chart – fixed jib (No. 0806.xx)

Offset 30°

Main boom 20 m

Radius (m)	Fixed jib length in (m)			
	11	20	26	32
8.2	t	t	t	t
14	24.0	12.1		
18	19.4	11.8	9.6	
22	16.9	10.5	8.0	3.6
24	16.1	9.9	7.5	3.5
26	15.2	9.7	7.1	3.4
28	14.7	9.7	6.8	3.3
30	14.2	9.7	6.6	3.3
38		9.2	6.5	3.1
40		6.8	6.4	3.1
44			6.2	3.1
50				3.0

Main boom 28.7 m

Radius (m)	Fixed jib length in (m)			
	11	20	26	32
8.5	t	t	t	t
15	24.0	12.1		
19	20.0	12.1	9.6	
22	18.8	12.1	8.7	3.6
26	16.9	11.4	8.1	3.4
30	15.7	11.0	7.6	3.3
34	14.7	10.7	7.2	3.2
36	14.2	10.5	7.1	3.2
38	13.1	10.2	7.0	3.1
46		9.4	6.4	3.0
50			6.1	3.0
55				3.1

Main boom 40.4 m

Radius (m)	Fixed jib length in (m)			
	11	20	26	32
8.9	t	t	t	t
15	23.2	12.1		
19	20.0	12.1	11.5	
24	18.8	12.1	10.2	3.5
32	16.4	12.0	8.7	3.2
36	13.8	11.4	8.1	3.2
40	10.8	10.8	7.6	3.1
44	10.2	9.8	7.1	3.0
48	7.7	8.3	6.7	3.0
55		6.3	6.2	3.0
60			5.4	3.0
65				3.1

Main boom 52.1 m

Radius (m)	Fixed jib length in (m)			
	11	20	26	32
9.4	t	t	t	t
16	21.9	12.1		
19	19.3	12.1	11.2	
24	18.3	12.1	10.3	3.4
32	15.9	12.1	9.0	3.2
40	10.2	11.0	7.9	3.1
44	9.7	9.3	7.5	3.0
48	8.3	7.8	7.2	3.0
55	5.2	5.8	6.2	2.9
65		4.9	4.0	2.9
70			4.4	2.9
75				2.9

Main boom 58.1 m

Radius (m)	Fixed jib length in (m)			
	11	20	26	32
9.6	t	t	t	t
16	21.1	12.1		
20	18.4	12.1	10.7	
24	17.5	12.1	10.2	3.3
32	15.4	11.9	9.1	3.2
40	9.9	10.6	8.1	3.1
44	9.4	9.0	7.7	3.0
55	6.1	6.8	5.9	2.9
60	5.0	4.4	4.7	2.9
70		3.8	2.8	2.8
75			3.4	2.9
80				2.9

Main boom 66.8 m

Radius (m)	Fixed jib length in (m)			
	11	20	26	32
9.9	t	t	t	t
16	19.5	12.1		
20	16.9	12.1	9.8	
24	15.7	12.1	9.5	3.3
28	15.3	11.6	9.3	3.3
36	12.2	10.6	8.5	3.1
40	10.5	9.8	8.2	3.1
55	5.7	6.4	5.3	2.9
65	3.6	4.3	3.3	2.8
70	2.8	3.4	3.8	2.8
80		2.0	2.4	2.7
85				2.1

Main boom 72.5 m

Radius (m)	Fixed jib length in (m)			
	11	20	26	32
10.1	t	t	t	t
16	18.2	8.6		
20	15.6	8.3	5.2	
24	14.5	7.9	5.0	3.3
32	13.5	7.5	4.7	3.2
40	10.0	7.3	4.5	3.0
48	7.3	6.8	4.4	3.0
55	5.4	6.1	4.3	2.9
65	3.4	4.0	4.2	2.8
70	2.6	3.2	3.6	2.8
75		2.4	2.8	2.8
80			2.1	2.5

Main boom 75.5 m

Radius (m)	Fixed jib length in (m)			
	11	20	26	29
10.2	t	t	t	t
16	17.1	8.6		
20	14.7	8.3	5.1	
22	14.2	8.1	5.0	4.0
26	13.3	7.8	4.9	3.9
30	12.8	7.6	4.7	3.9
46	7.6	7.0	4.4	3.6
50	6.4	6.6	4.4	3.6
60	4.1	4.8	4.3	3.5
70	2.4	3.0	3.4	3.4
75		2.3	2.7	2.8
80			2.0	2.2

Main boom 78.5 m

Radius (m)	Fixed jib length in (m)			
	11	14	17	20
10.3	t	t	t	t
13	16.3	13.5		
15	15.3	13.2	10.5	
17	14.8	12.9	10.3	8.2
24	13.1	11.1	9.5	7.5
32	11.4	10.2	8.9	7.2
40	9.4	9.4	8.6	6.9
48	6.7	7.0	7.2	6.6
55	5.0	5.2	5.4	5.6
65	3.1	3.3	3.5	3.7
70	2.3	2.5	2.7	2.9
75				2.1

Capacities in metric tons with fixed jib (No. 0806.xx) 55 t counterweight + 15 t carbody counterweight. Above lift chart is for reference only. For actual lift duty and complete chart with all available configurations please refer to lift chart in operator's cab or manual.

Working range - fixed jib (No. 1008.xx) 15° and 30°

Main boom 88°- 30°

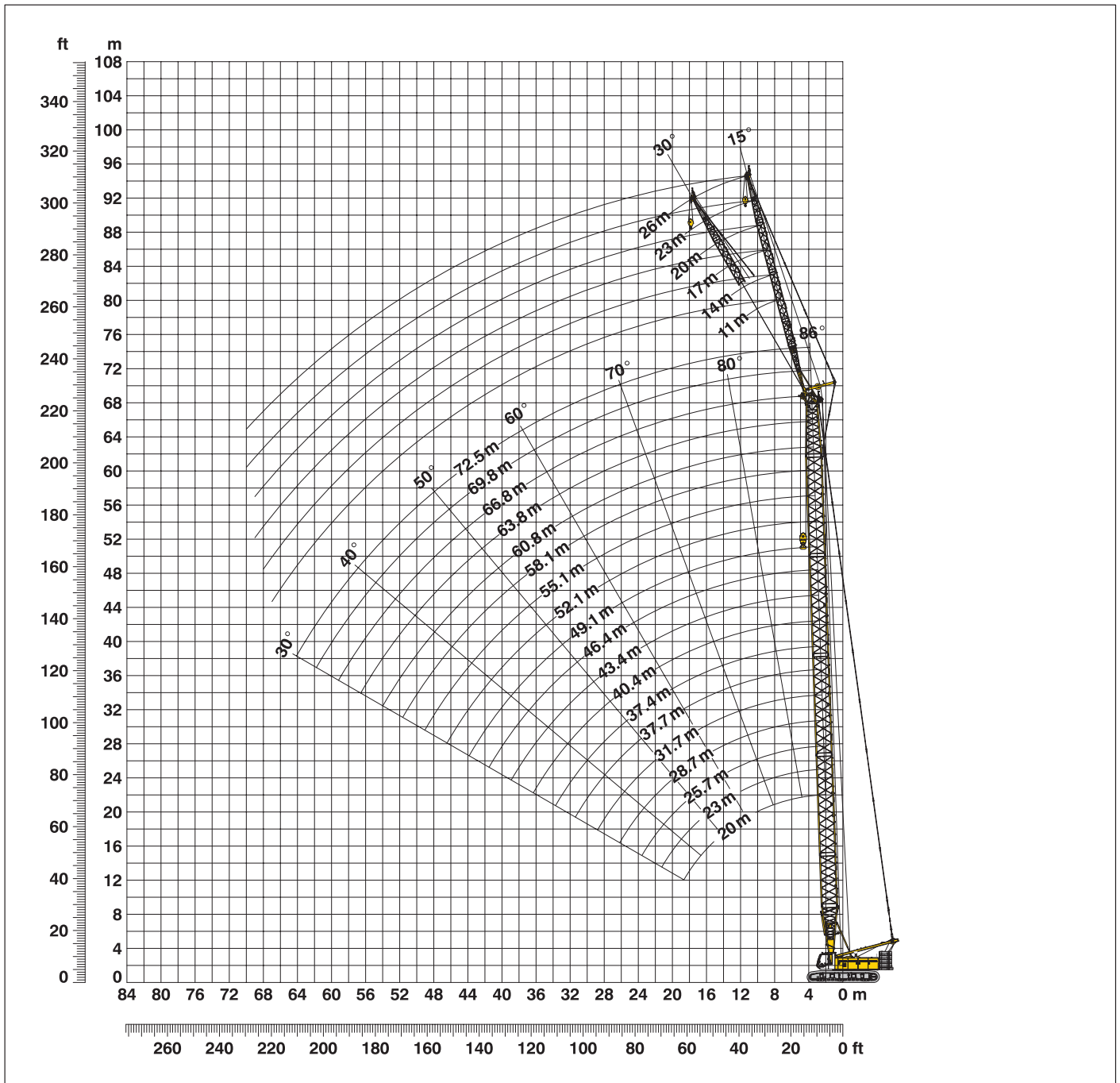

Boom configuration for boom lengths (20 m - 72.5 m) – see table 1 on page 12

Fixed jib configuration for fixed jib lengths (11 m - 26 m)

	Length	Amount of fixed jib extensions					
Fixed jib foot	5.5 m	1	1	1	1	1	1
Fixed jib insert	3.0 m		1		1		1
Fixed jib insert	6.0 m			1	1	2	2
Fixed jib head	5.5 m	1	1	1	1	1	1
Fixed jib length (m)		11	14	17	20	23	26

Lift chart – fixed jib (No. 1008.xx)

Offset 15°

Main boom 20 m

Radius (m)	Fixed jib length in (m)			
	11	14	20	26
5.5	t	t	t	t
7	35.9	35.9		
9	35.9	34.5	26.2	
12	34.7	29.5	21.5	17.5
16	31.5	24.1	17.7	14.1
20	29.6	22.8	14.9	11.8
24	24.0	21.0	14.2	10.5
28	19.4	18.6	13.5	10.2
30	17.5	17.8	12.9	10.2
32		16.2	12.3	10.0
38			11.2	8.7
44				7.7

Main boom 28.7 m

Radius (m)	Fixed jib length in (m)			
	11	14	20	26
5.8	35.9			
7	35.9	34.7		
10	35.9	32.7	26.6	
12	35.9	31.6	24.5	17.5
16	34.4	29.3	21.3	15.1
20	30.3	26.7	18.8	13.4
28	19.0	19.2	15.7	11.0
32	15.7	15.9	14.6	10.7
36	13.1	13.3	13.5	10.3
40		11.3	11.7	9.6
46			9.3	8.4
50				7.9

Main boom 40.4 m

Radius (m)	Fixed jib length in (m)			
	11	14	20	26
6.2	35.9			
8	35.9	34.4		
10	35.9	33.6	26.9	
12	35.9	32.8	25.8	17.2
20	28.2	27.8	20.8	14.4
28	18.4	18.7	17.5	12.6
36	12.5	12.7	13.1	10.9
44	9.0	9.1	9.5	9.7
48	7.6	7.8	8.1	8.3
50		7.2	7.5	7.7
55			6.1	6.4
60				5.3

Main boom 46.4 m

Radius (m)	Fixed jib length in (m)			
	11	14	20	26
6.4	35.9			
8	35.9	33.6		
10	35.9	33.1	25.4	
13	35.5	32.0	24.2	16.5
20	27.0	27.0	20.3	14.2
28	18.0	18.0	17.4	12.5
36	12.2	12.4	12.8	10.9
44	8.6	8.8	9.1	9.4
50	6.7	6.8	7.2	7.4
55		5.5	5.8	6.1
60			4.7	5.0
65				4.0

Main boom 52.1 m

Radius (m)	Fixed jib length in (m)			
	11	14	20	26
6.6	35.9			
8	35.9	32.5		
11	35.4	31.7	23.3	
13	34.8	30.6	22.5	15.7
20	26.0	25.9	19.5	13.8
28	17.2	17.3	16.7	12.3
36	12.0	12.1	12.4	10.8
44	8.4	8.5	8.9	9.1
55	5.1	5.3	5.6	5.8
60		4.2	4.5	4.7
65			3.5	3.8
70				2.9

Main boom 58.1 m

Radius (m)	Fixed jib length in (m)			
	11	14	20	26
6.8	34.8			
8	34.6	30.3		
11	32.9	29.4	21.5	
13	31.4	28.0	20.9	14.8
20	24.9	23.0	18.2	13.3
28	16.4	16.5	15.7	11.4
36	11.5	11.6	11.7	10.6
44	8.0	8.2	8.5	8.6
55	4.8	4.9	5.2	5.5
60	3.7	3.9	4.1	4.4
65		2.9	3.2	3.4
70			2.4	2.6

Main boom 66.8 m

Radius (m)	Fixed jib length in (m)			
	11	14	20	26
7.1	27.9			
9	27.4	24.3		
11	26.4	23.2	18.1	
13	25.2	22.3	17.7	13.3
20	20.6	19.0	15.6	12.2
28	15.3	15.4	13.4	10.6
36	10.6	10.7	10.9	9.8
44	7.4	7.5	7.7	7.8
48	6.2	6.3	6.5	6.6
55	4.4	4.5	4.7	4.8
65	2.4	2.5	2.8	2.9
70				2.1

Main boom 69.8 m

Radius (m)	Fixed jib length in (m)			
	11	14	17	20
7.2	24.6			
9	24.3	20.3		
10	24.0	20.2	18.3	
11	22.5	20.2	18.2	16.2
16	20.6	18.9	17.2	15.4
20	18.5	17.5	16.1	14.5
28	14.9	14.7	13.7	12.5
36	10.3	10.4	10.5	10.6
44	7.1	7.2	7.3	7.4
48	5.9	6.0	6.1	6.2
55	4.1	4.2	4.4	4.4
65	2.2	2.3	2.5	2.5

Main boom 72.5 m

Radius (m)	Fixed jib length in (m)			
	11	14		
7.3	22.4			
9	22.3	19.6		
10	22.1	19.5		
12	21.3	19.2		
16	19.2	17.4		
20	17.3	15.8		
28	14.5	13.2		
36	10.0	10.1		
44	6.9	7.0		
48	5.7	5.8		
55	3.9	4.0		
65	2.1	2.1		

Capacities in metric tons with fixed jib (No. 1008.xx) 55 t counterweight + 15 t carbody counterweight. Above lift chart is for reference only. For actual lift duty and complete chart with all available configurations please refer to lift chart in operator's cab or manual.

Lift chart – fixed jib (No. 1008.xx)

Offset 30°

Main boom 20 m

Radius (m)	Fixed jib length in (m)			
	11	14	20	26
8.1	t	t	t	t
10	32.0			
14	28.4	23.5		
18	23.6	19.1	14.1	
22	21.8	16.5	11.8	9.6
24	21.6	15.7	10.5	8.0
26	20.9	15.7	9.9	7.5
28	20.1	15.3	9.7	7.1
30	19.4	14.8	9.7	6.8
34	17.6	14.4	9.7	6.6
40		12.1	9.5	6.6
46			9.0	6.4
46				6.0

Main boom 28.7 m

Radius (m)	Fixed jib length in (m)			
	11	14	20	26
8.4	t	t	t	t
11	33.3			
14	29.8	25.2		
18	27.2	22.6	15.4	
24	24.5	20.4	13.3	10.0
28	22.8	18.2	11.8	8.4
32	19.3	17.5	11.1	7.8
36	15.8	16.1	10.9	7.3
38	13.2	13.5	10.5	7.1
40	12.1	12.4	10.2	7.0
46		11.4	9.9	6.9
50			9.4	6.4
50				6.1

Main boom 40.4 m

Radius (m)	Fixed jib length in (m)			
	11	14	20	26
8.8	t	t	t	t
11	35.7			
15	34.2	27.9		
19	30.5	25.1	17.0	
24	27.8	22.9	15.2	11.5
32	23.3	20.7	13.6	10.2
40	15.4	15.7	12.0	8.7
44	10.8	11.0	10.8	7.6
48	9.1	9.3	9.8	7.1
50	7.7	7.9	8.3	6.7
55		7.2	7.7	6.6
60			6.3	6.2
60				5.4

Main boom 46.4 m

Radius (m)	Fixed jib length in (m)			
	11	14	20	26
9	t	t	t	t
11	34.5			
15	33.7	27.1		
19	30.1	25.1	16.8	
24	27.4	22.8	15.4	11.5
32	22.4	20.5	13.9	10.3
40	15.1	15.4	12.1	8.9
48	10.5	10.7	11.1	7.8
50	7.4	7.6	8.1	6.9
55	6.8	7.0	7.4	6.8
60		5.6	6.0	6.4
65			4.8	5.2
65				4.1

Main boom 52.1 m

Radius (m)	Fixed jib length in (m)			
	11	14	20	26
9.2	t	t	t	t
12	32.4			
15	30.8	25.8		
19	28.6	24.2	16.5	
24	26.1	22.2	15.4	11.2
32	21.5	19.9	14.0	10.3
40	14.8	15.0	12.3	9.0
48	10.2	10.5	11.0	7.9
55	7.2	7.4	7.8	7.2
60	5.2	5.4	5.8	6.2
65		4.3	4.6	5.0
70			3.6	4.0
70				3.1

Main boom 58.1 m

Radius (m)	Fixed jib length in (m)			
	11	14	20	26
9.5	t	t	t	t
12	29.3			
15	28.1	24.0		
19	26.2	22.6	15.8	
24	24.0	20.8	15.1	10.8
32	20.7	18.9	13.9	10.2
40	14.1	14.3	12.3	9.1
48	9.9	10.2	10.6	8.1
55	6.9	7.1	7.6	7.3
60	3.8	4.0	4.4	4.7
65		3.0	3.4	3.7
70			2.5	2.8
75				2.0

Main boom 66.8 m

Radius (m)	Fixed jib length in (m)			
	11	14	20	26
9.8	t	t	t	t
12	23.4			
16	22.9	19.8		
19	21.1	18.7	13.9	
24	19.9	17.6	13.6	9.8
32	18.0	16.1	12.6	9.5
40	13.1	13.4	11.2	8.9
44	9.2	9.4	9.8	8.2
48	7.7	7.9	8.3	7.8
55	6.4	6.6	6.9	7.2
65	4.5	4.7	5.1	5.3
70	2.5	2.6	3.0	3.3
70			2.1	2.4

Main boom 69.8 m

Radius (m)	Fixed jib length in (m)			
	11	14	17	20
9.9	t	t	t	t
12	21.5			
14	21.1	17.5		
16	20.3	17.2	14.7	
24	19.6	16.8	14.8	13.1
32	16.8	14.9	13.2	10.0
36	12.8	12.9	11.1	9.8
40	10.7	10.9	10.8	9.5
44	8.9	9.1	9.3	9.2
48	7.4	7.6	7.8	8.0
55	6.2	6.3	6.5	6.7
65	4.3	4.5	4.7	4.8
65	2.3	2.5	2.7	2.8

Main boom 72.5 m

Radius (m)	Fixed jib length in (m)			
	11	14		
10	t	t		
12	19.4			
14	19.2	16.9		
18	18.7	16.5		
24	17.0	15.2		
32	14.7	13.4		
36	12.5	11.4		
40	10.4	10.7		
44	8.7	8.9		
48	7.2	7.4		
55	5.9	6.1		
65	4.1	4.3		
65	2.2	2.3		

Capacities in metric tons with fixed jib (No. 1008.xx) 55 t counterweight + 15 t carbody counterweight. Above lift chart is for reference only. For actual lift duty and complete chart with all available configurations please refer to lift chart in operator's cab or manual.

Notice

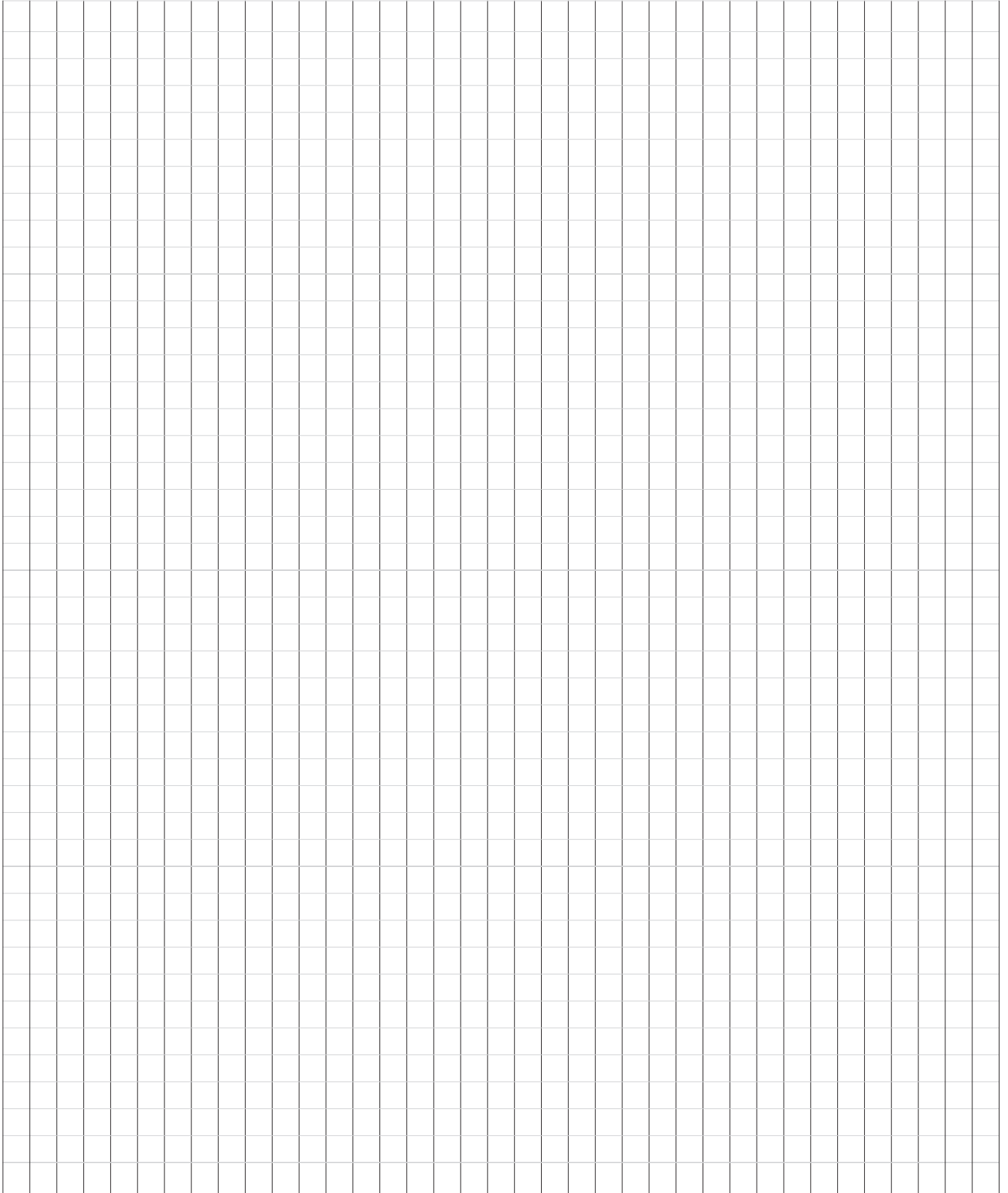

Notice

