

1

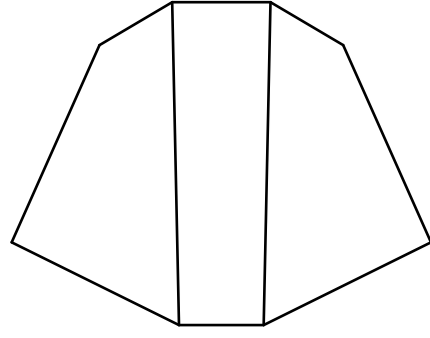

7a

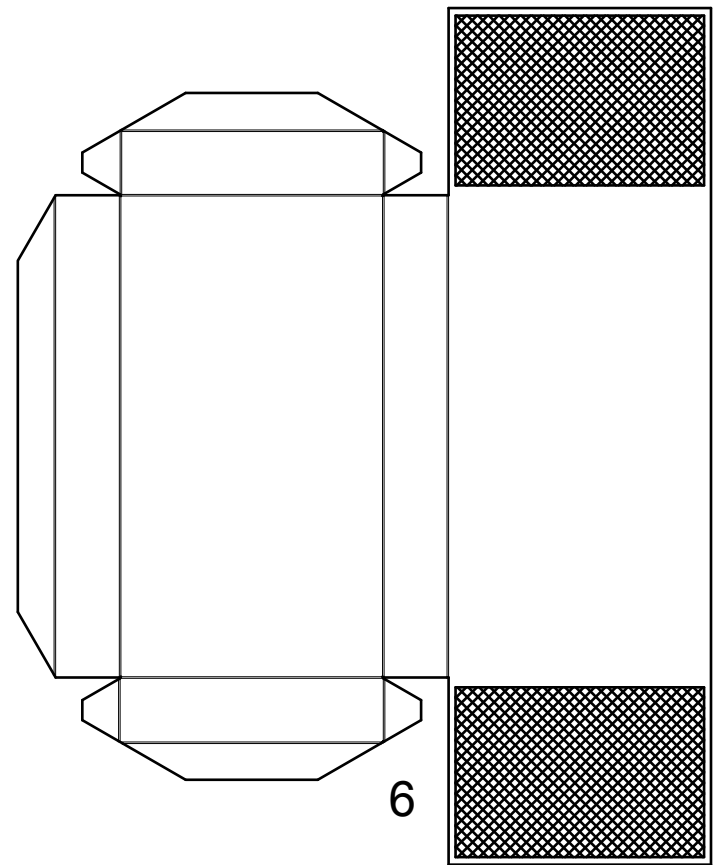
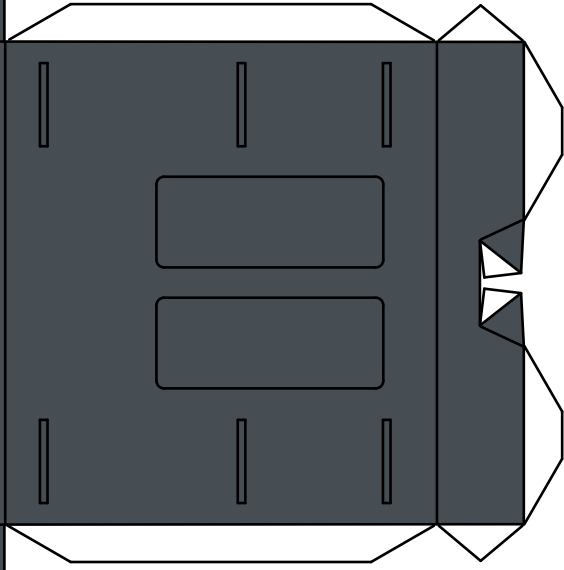

6

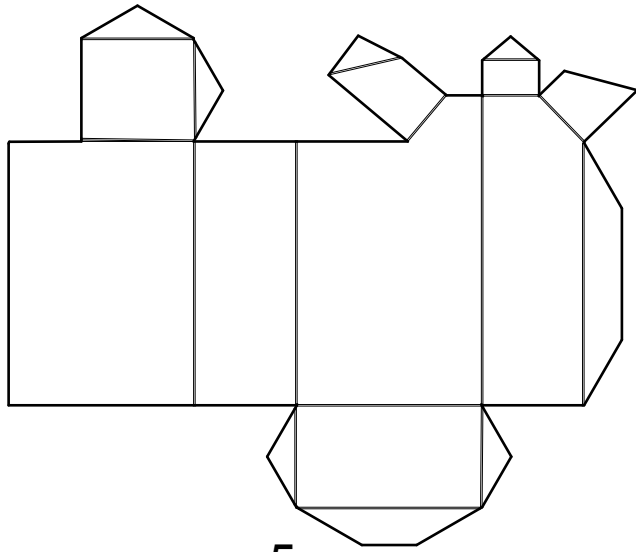

5

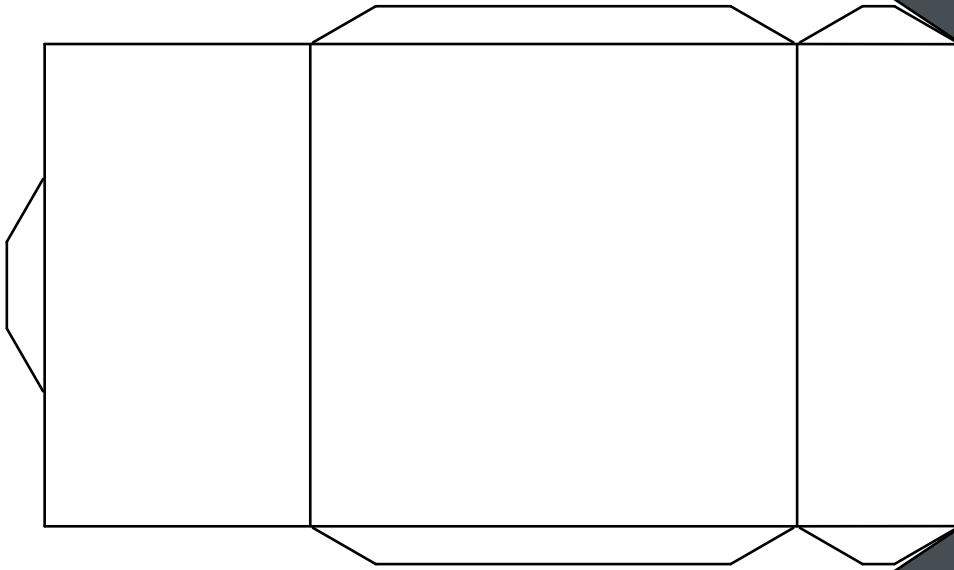
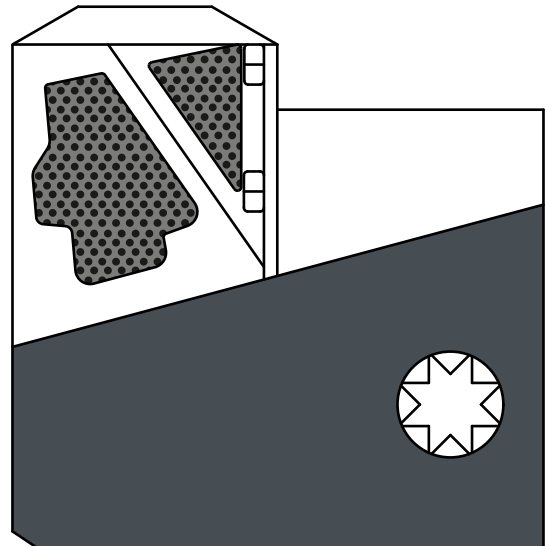

4

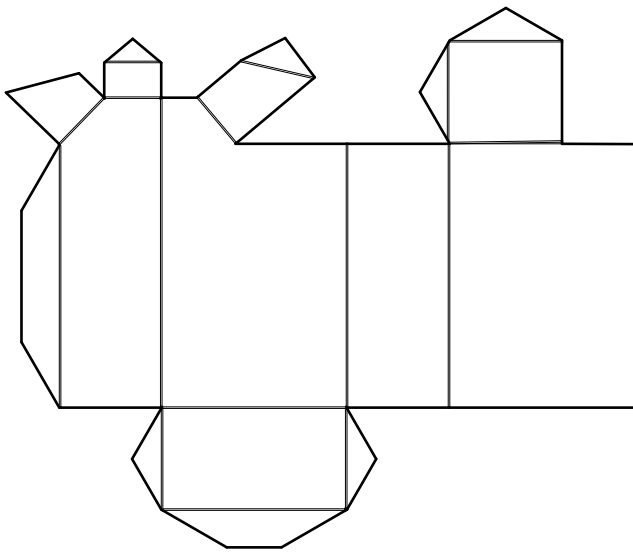
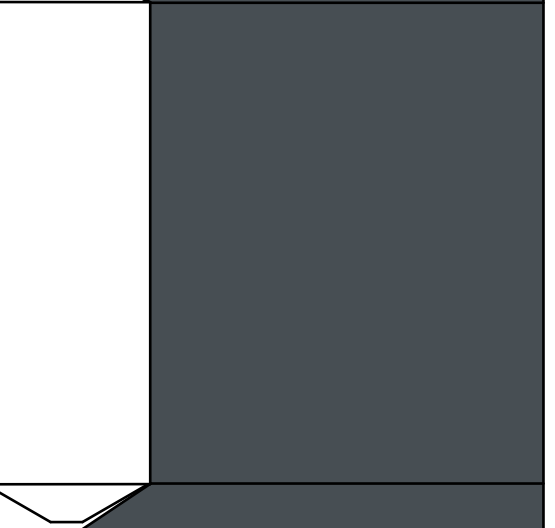

2

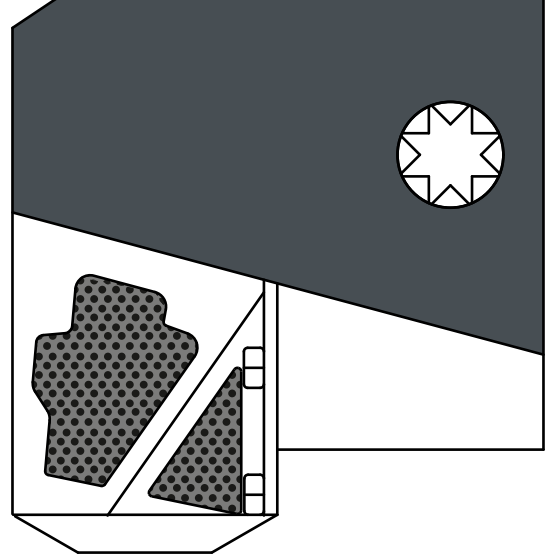

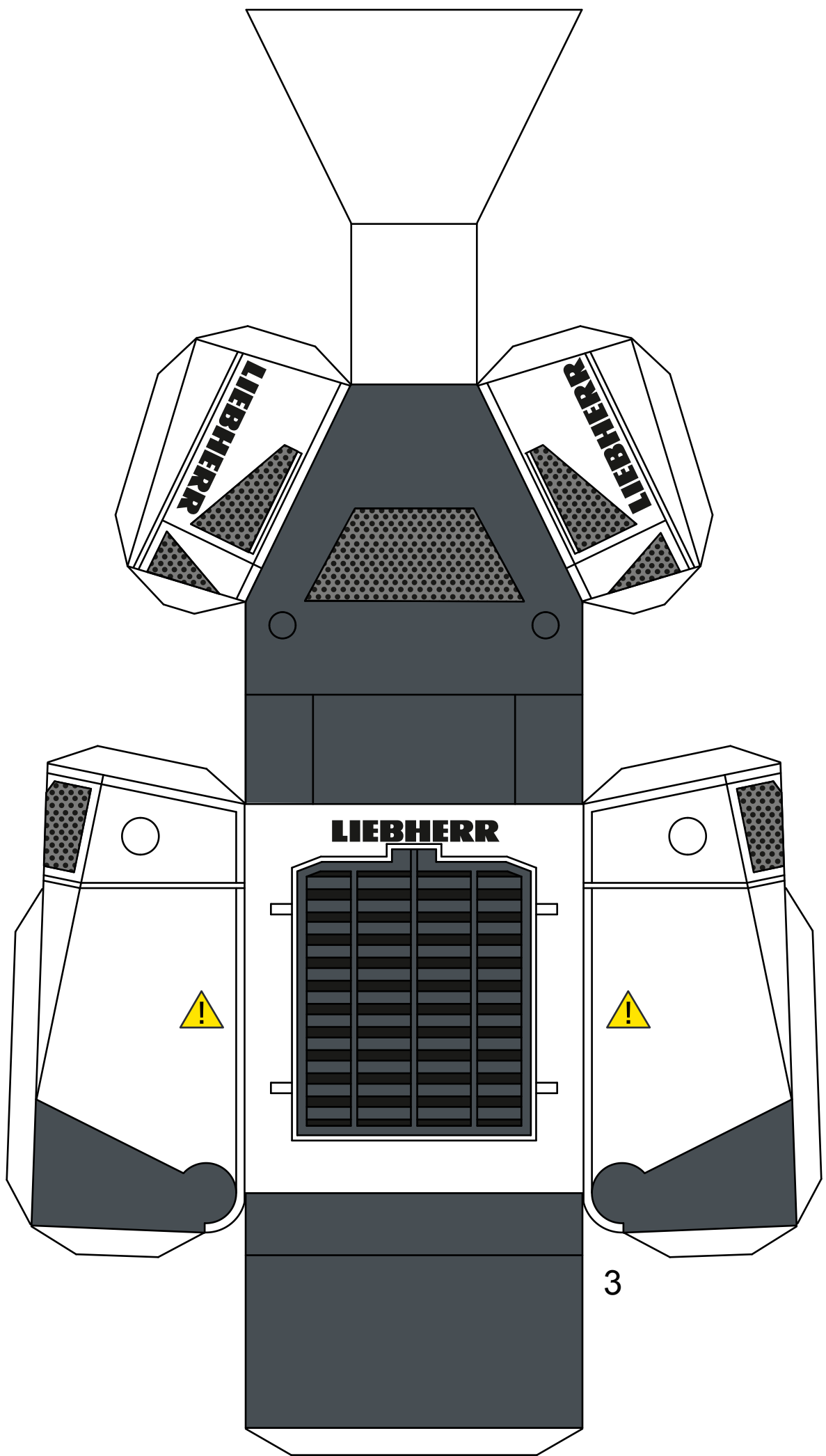

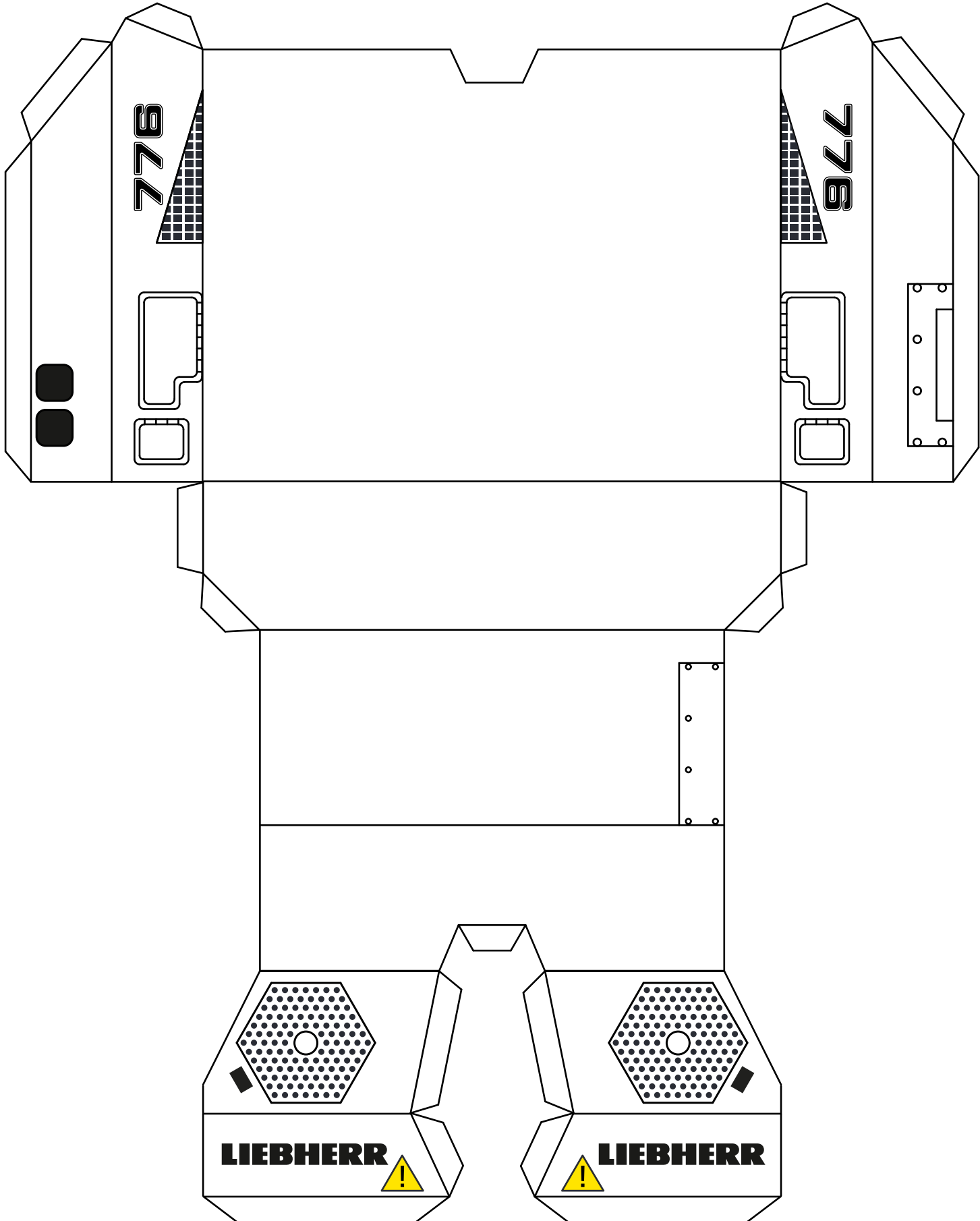

9

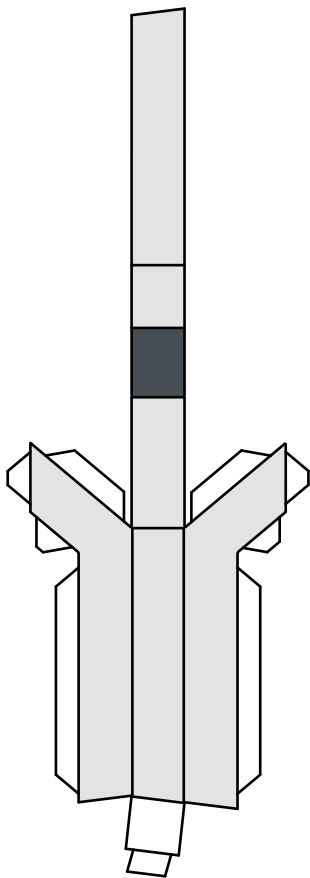

8

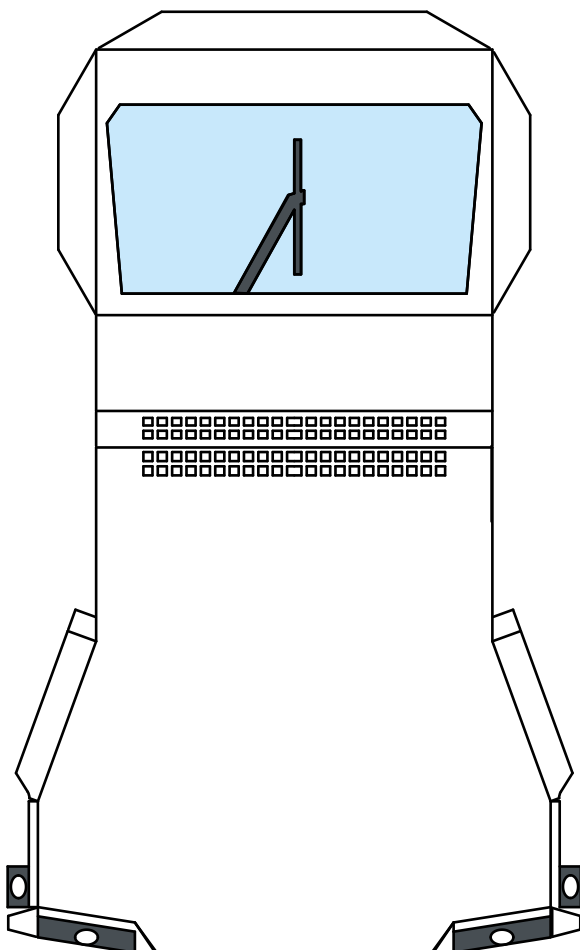

10

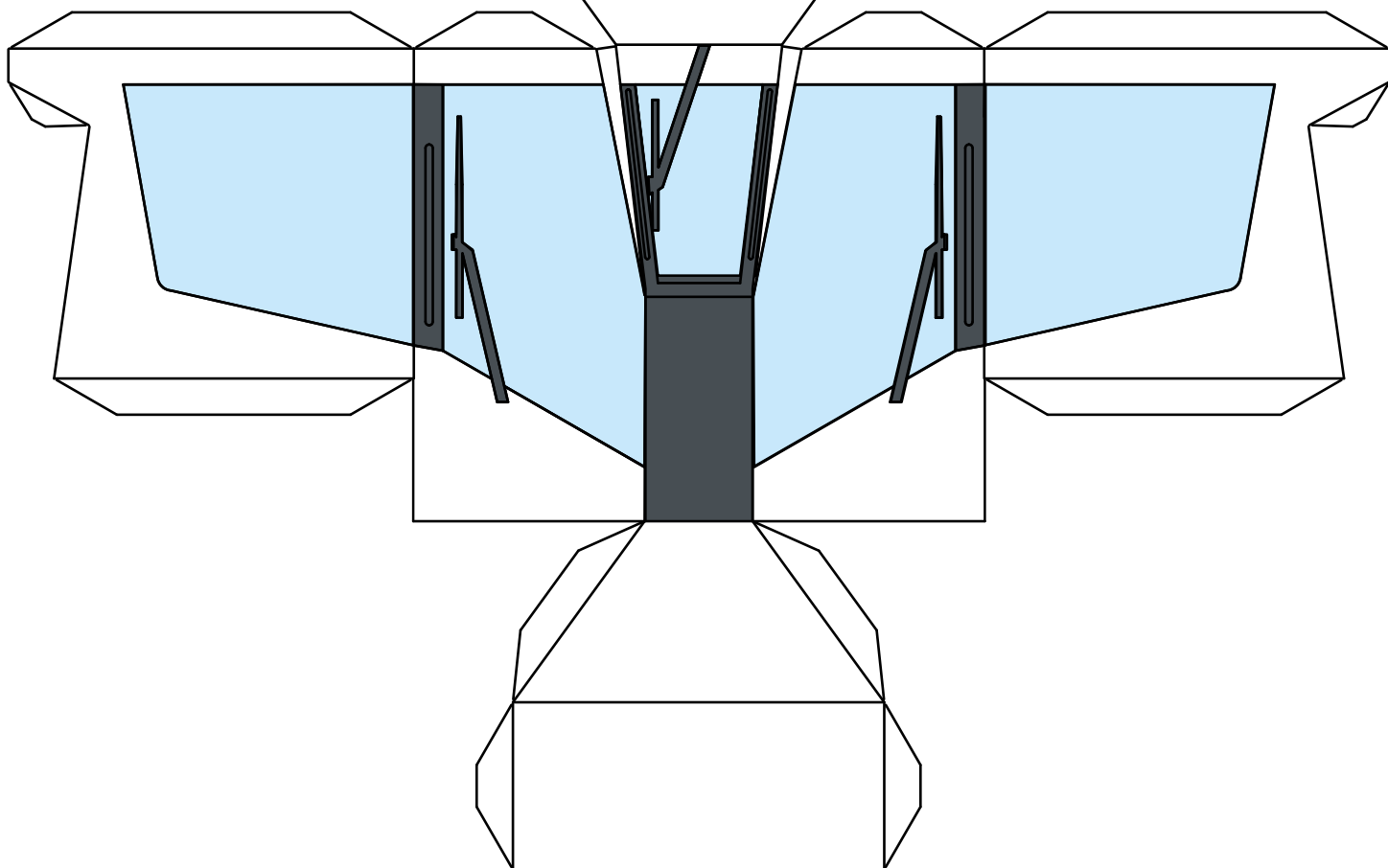
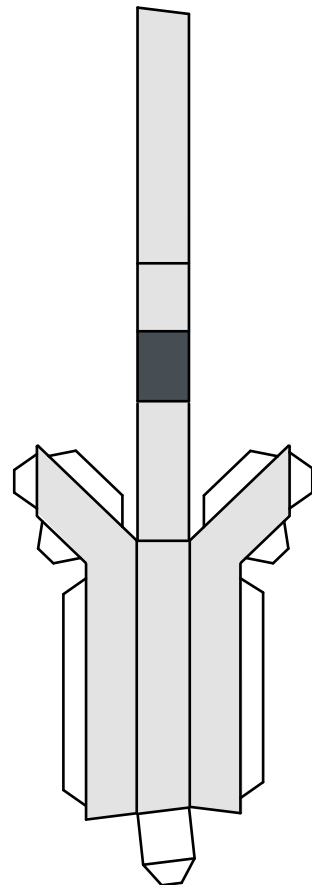

11

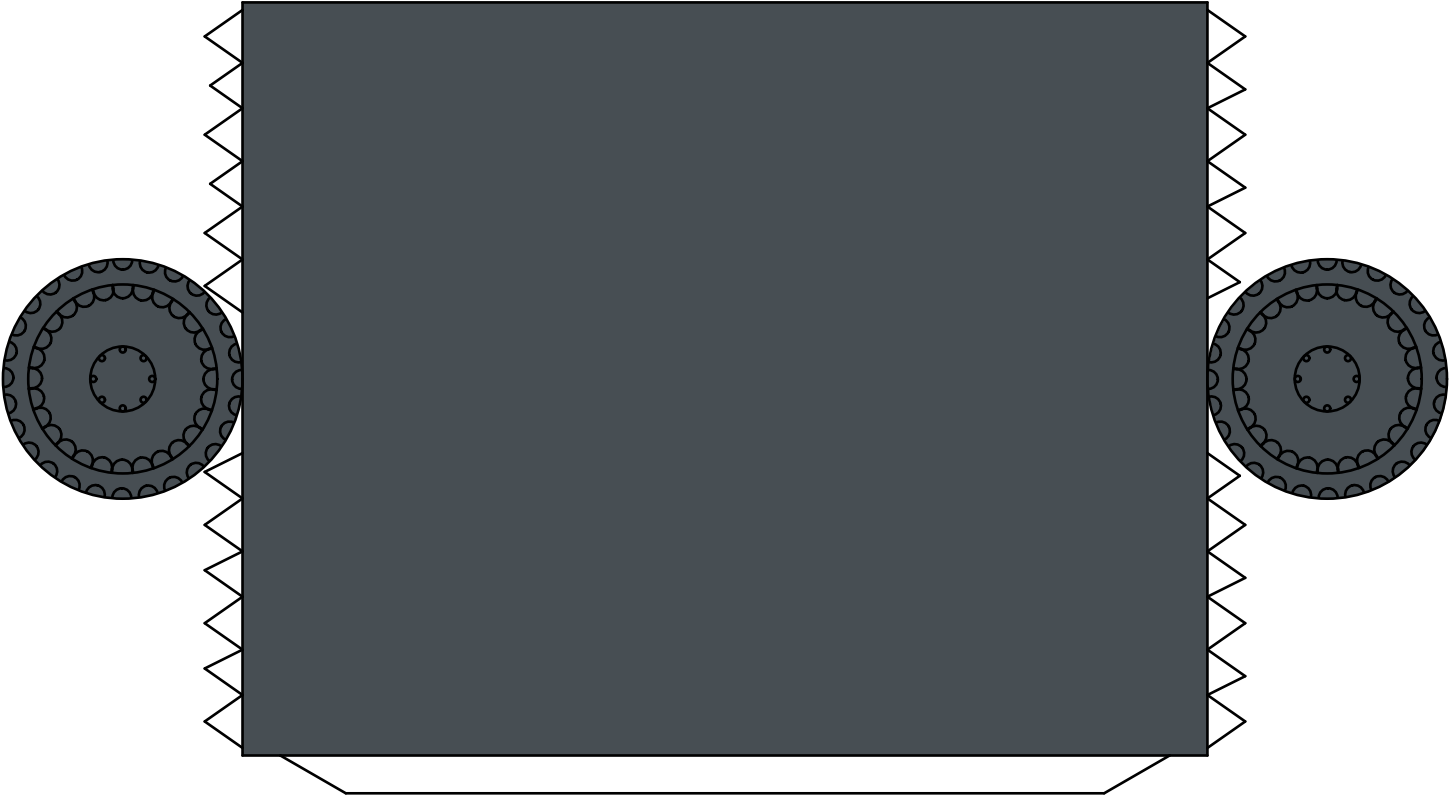

12

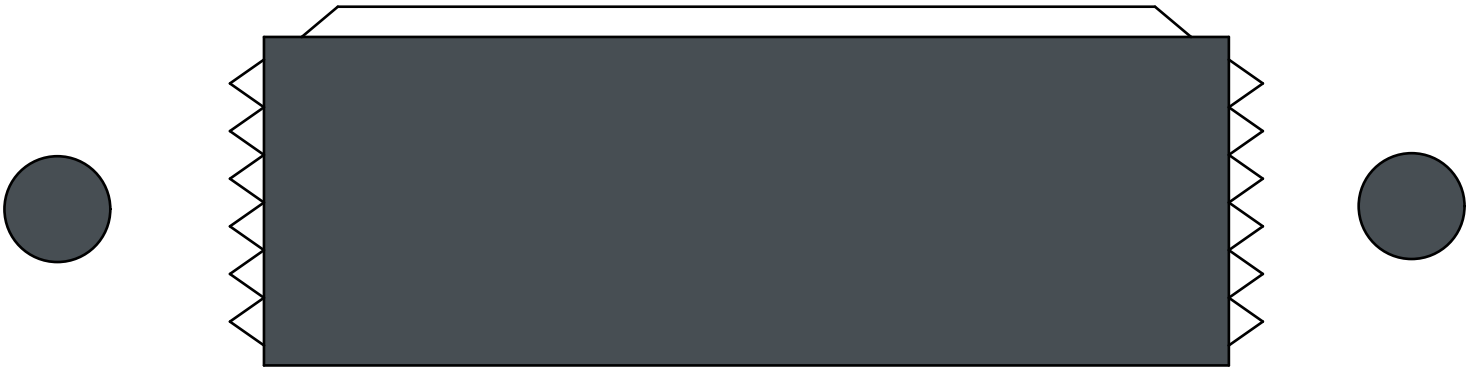

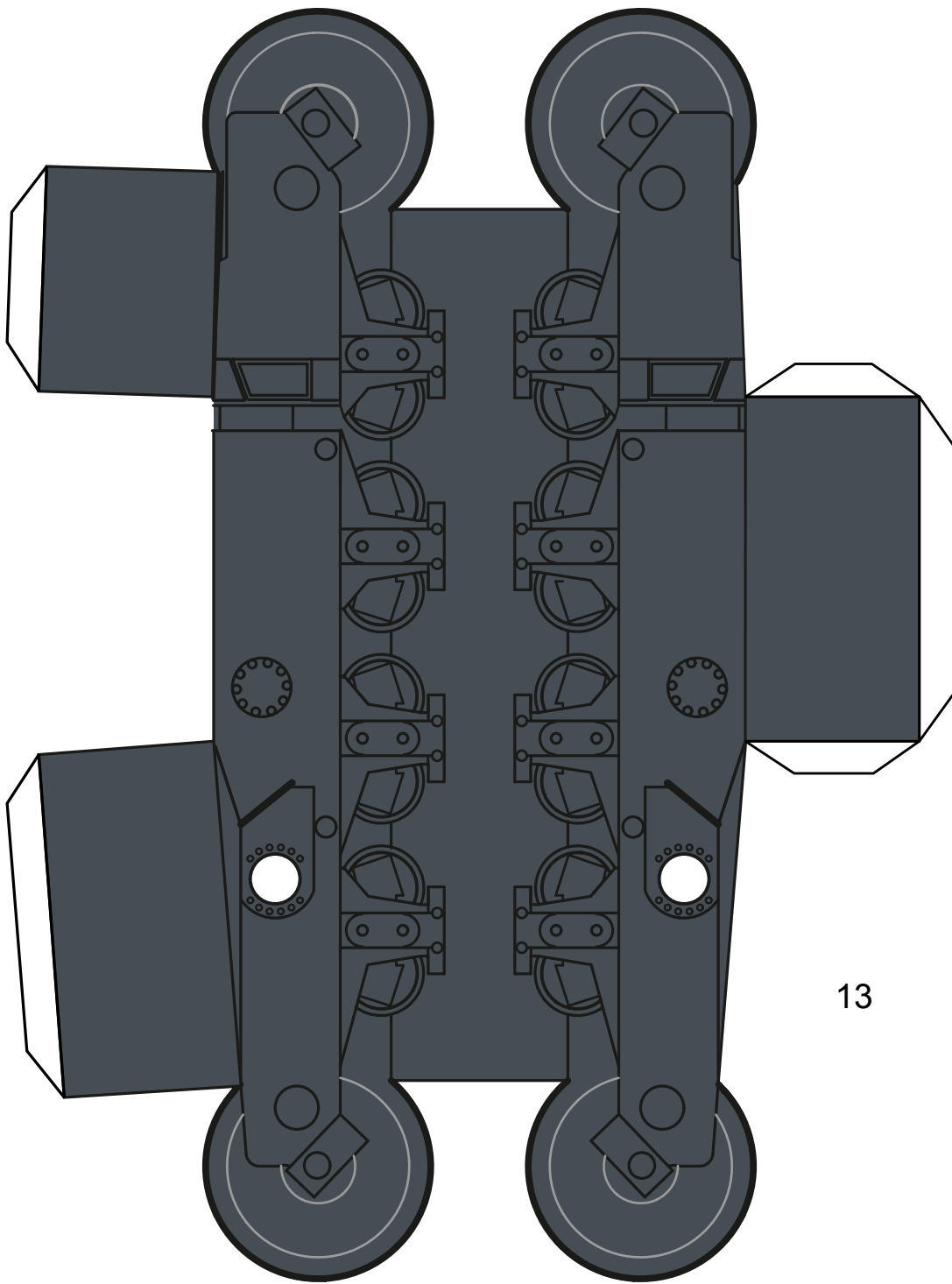

13

13A

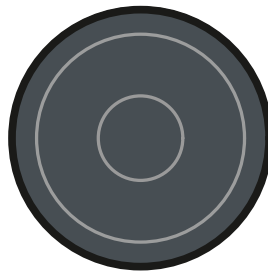

13B

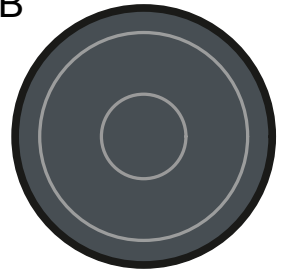

13D

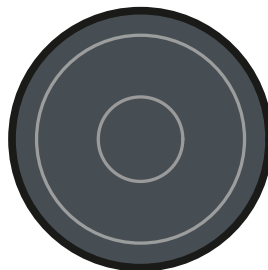

13C

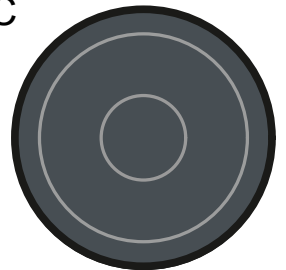

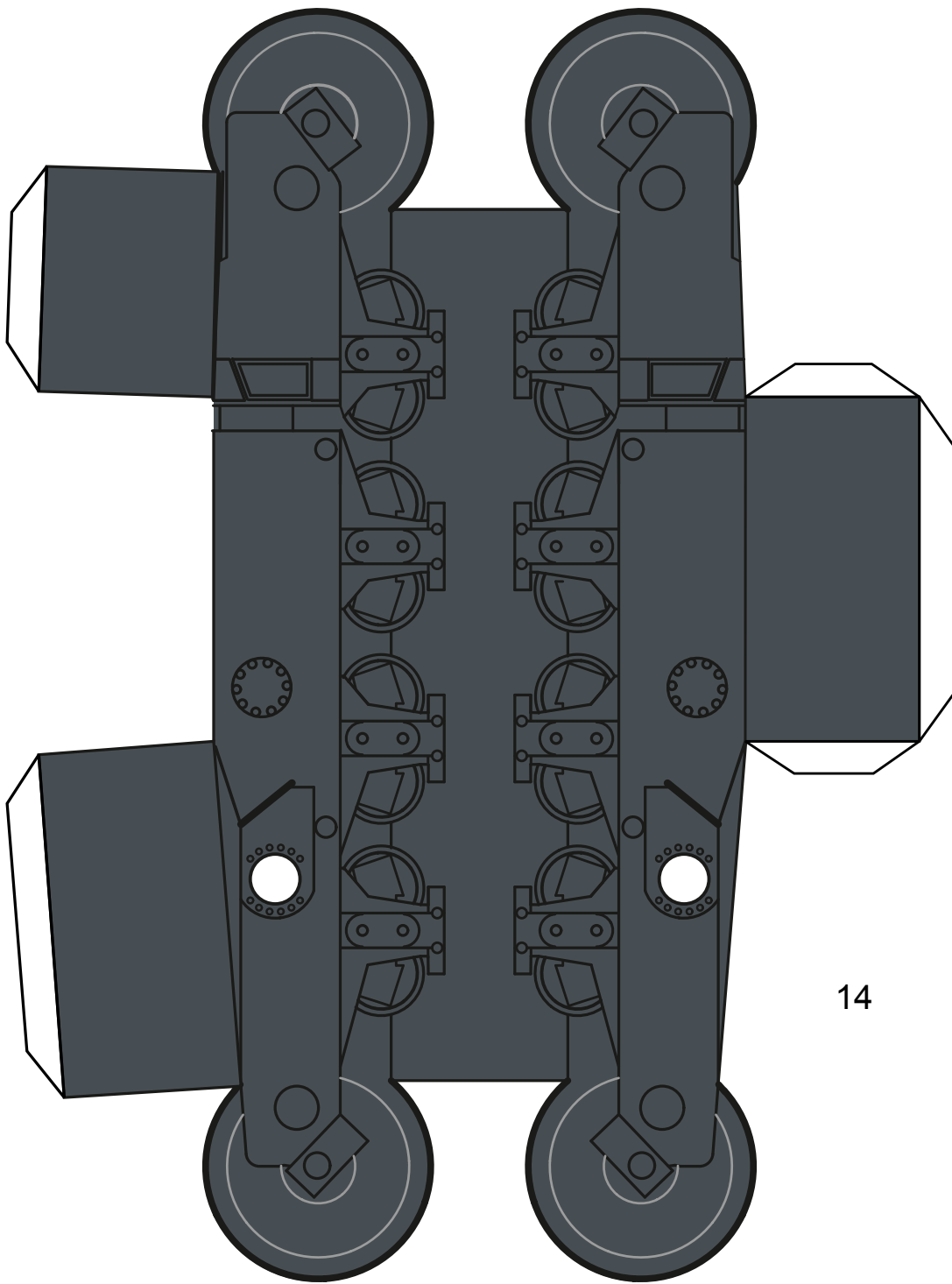

14

14A

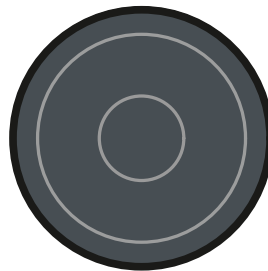

14B

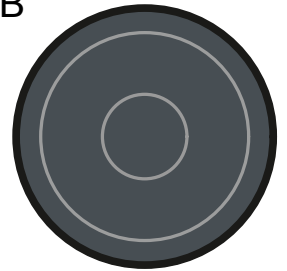

14D

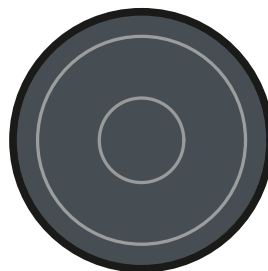

14C

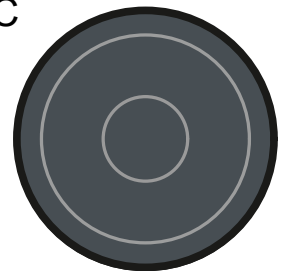



16A

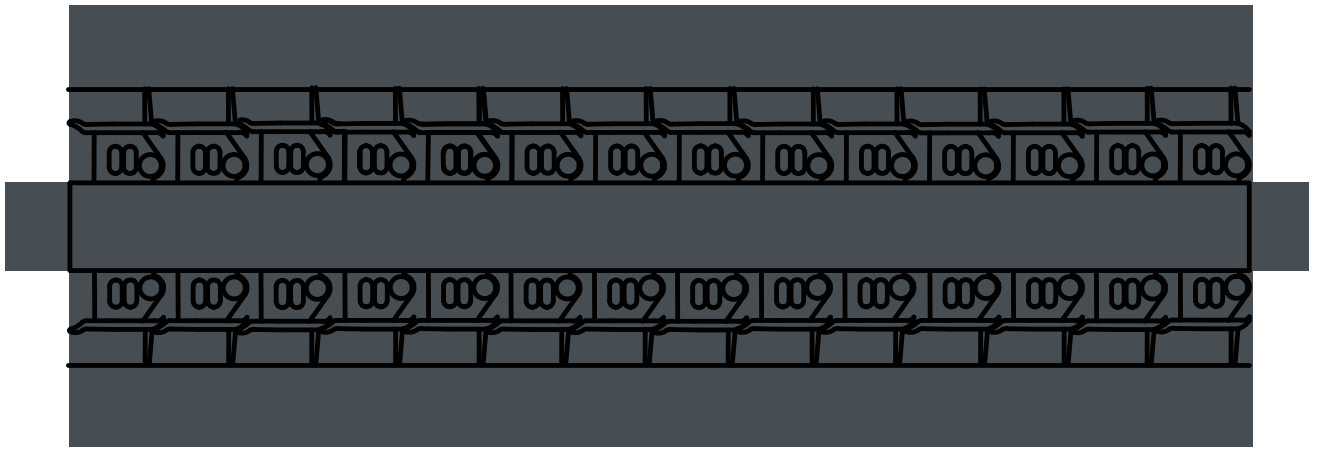

15A



20A



19A



16B



15B

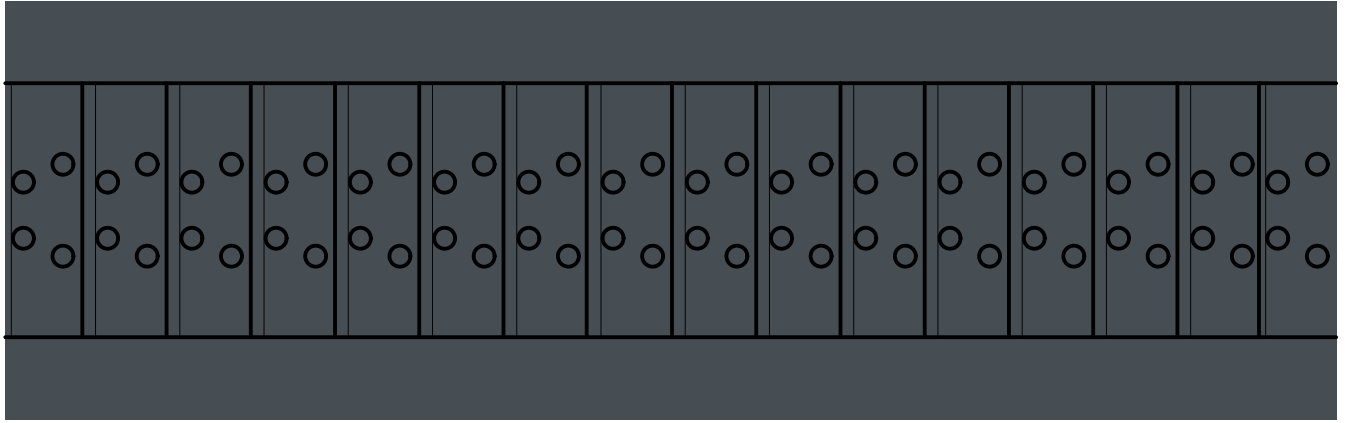

20B

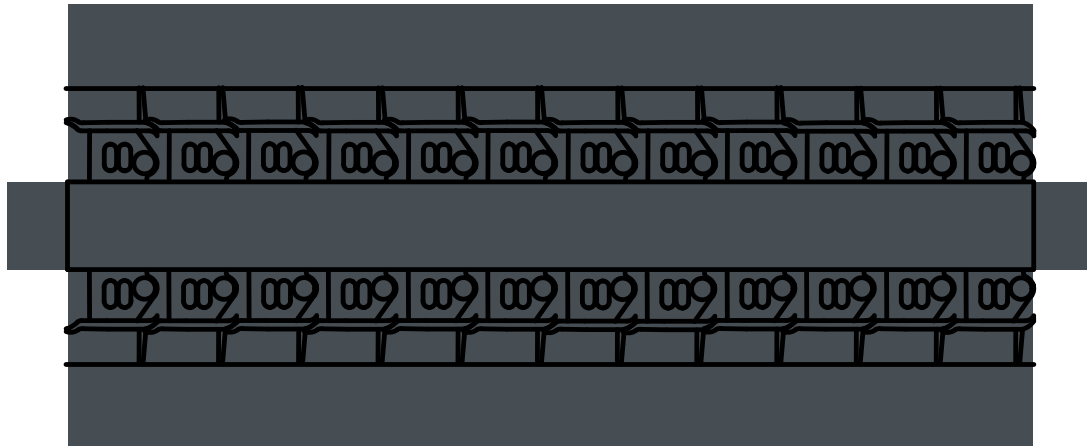

19B



18A

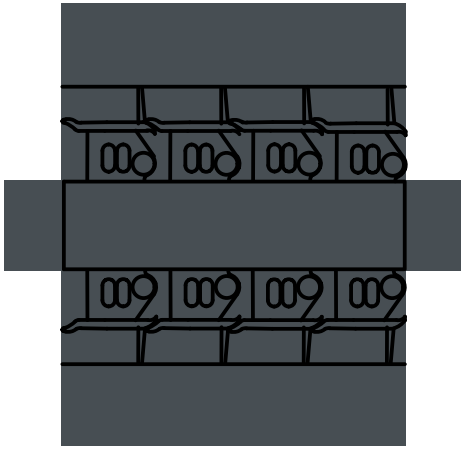

17A

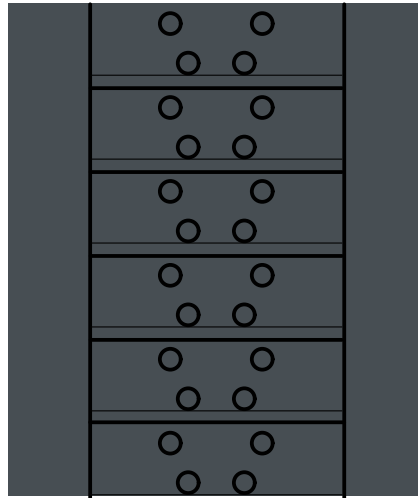

18B

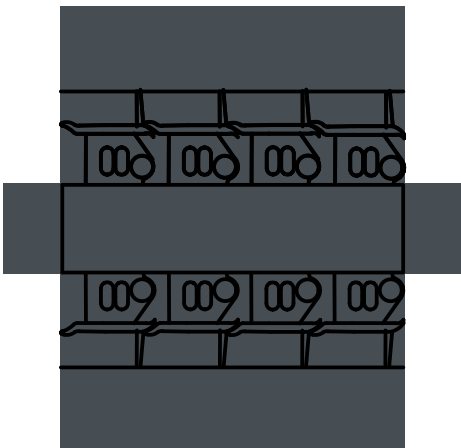

17B

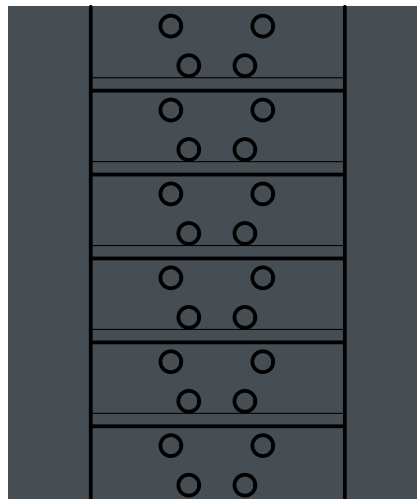

24A

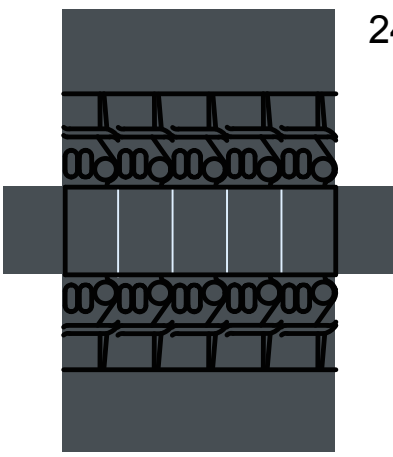

26A

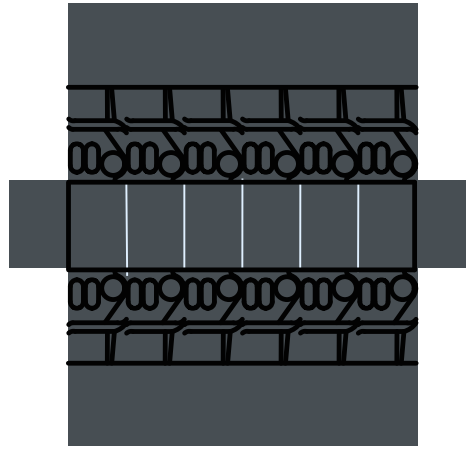

22A

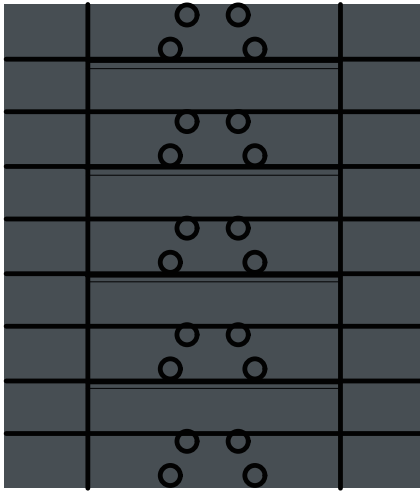
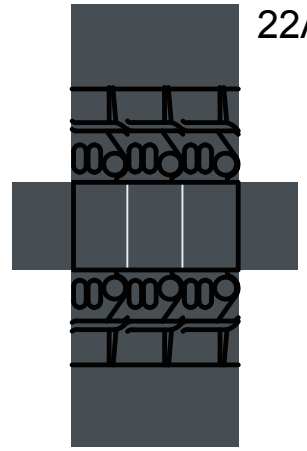

23A

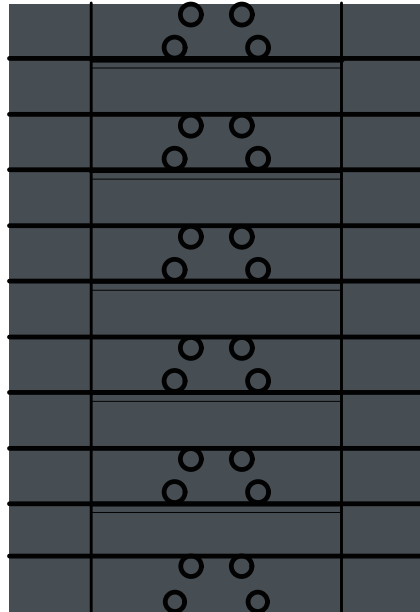

25A

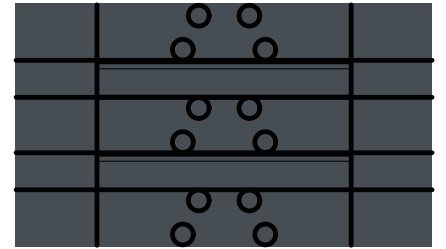

21A

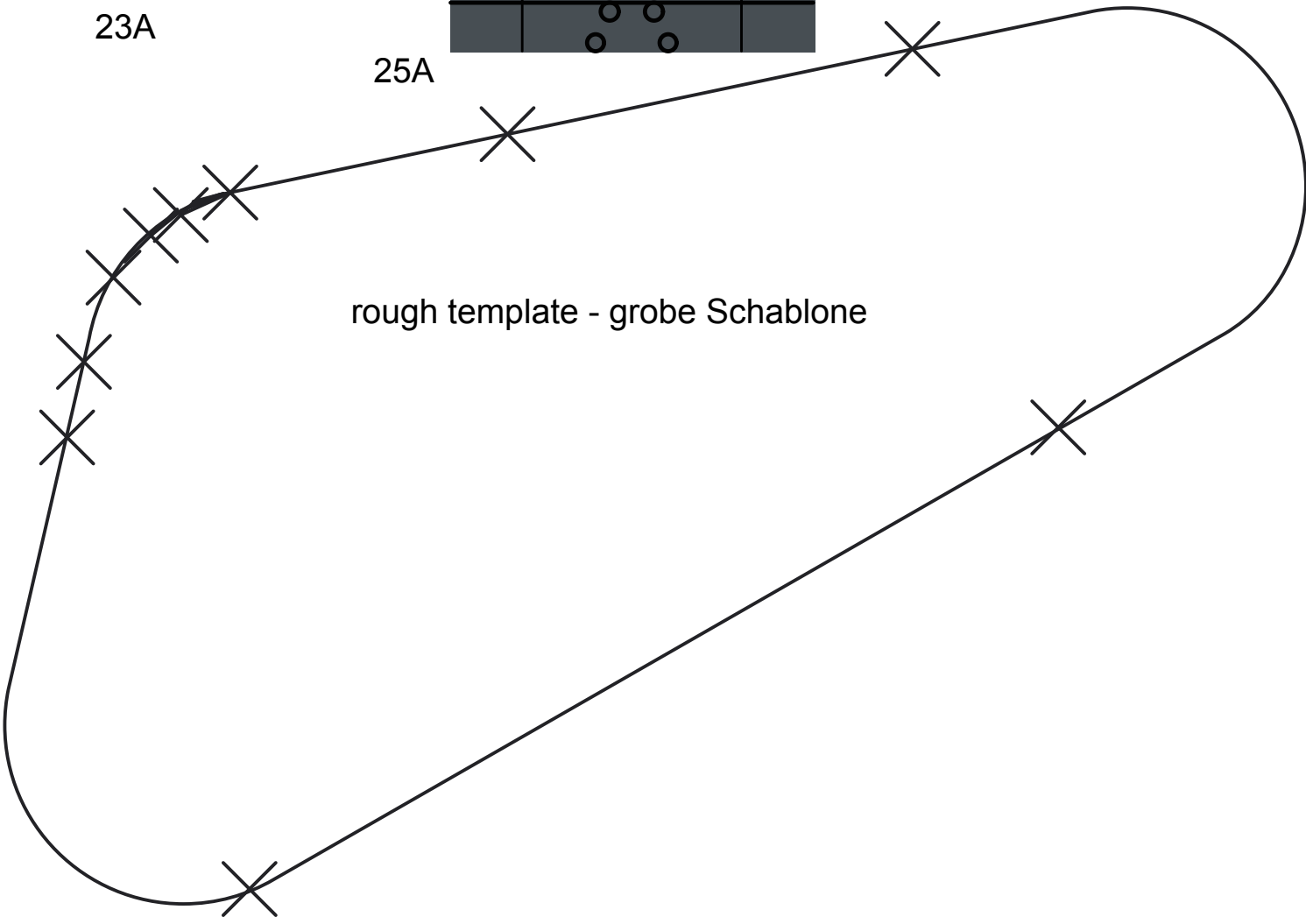

rough template - grobe Schablone

24B

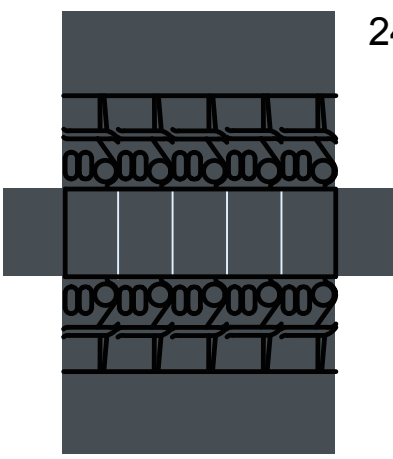

26B

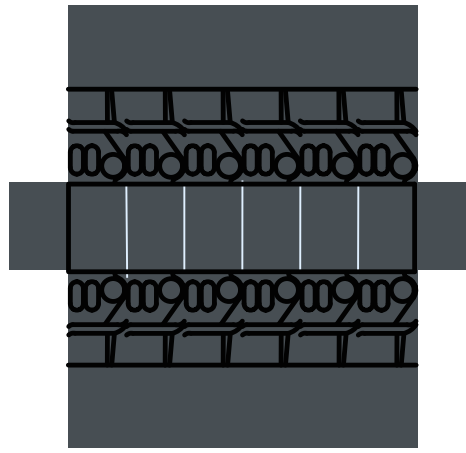

22B

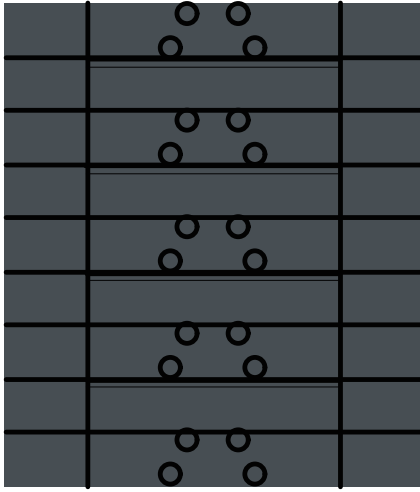
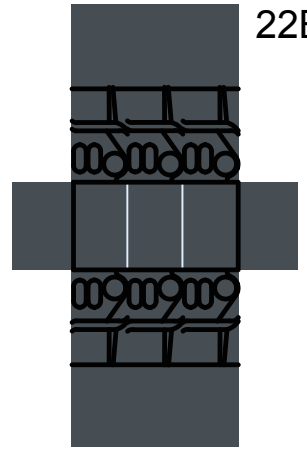

23B



25B

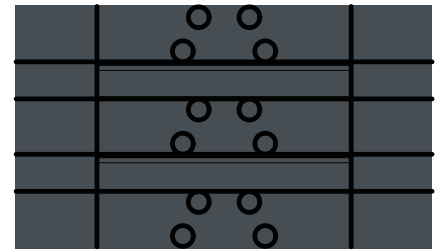

21B

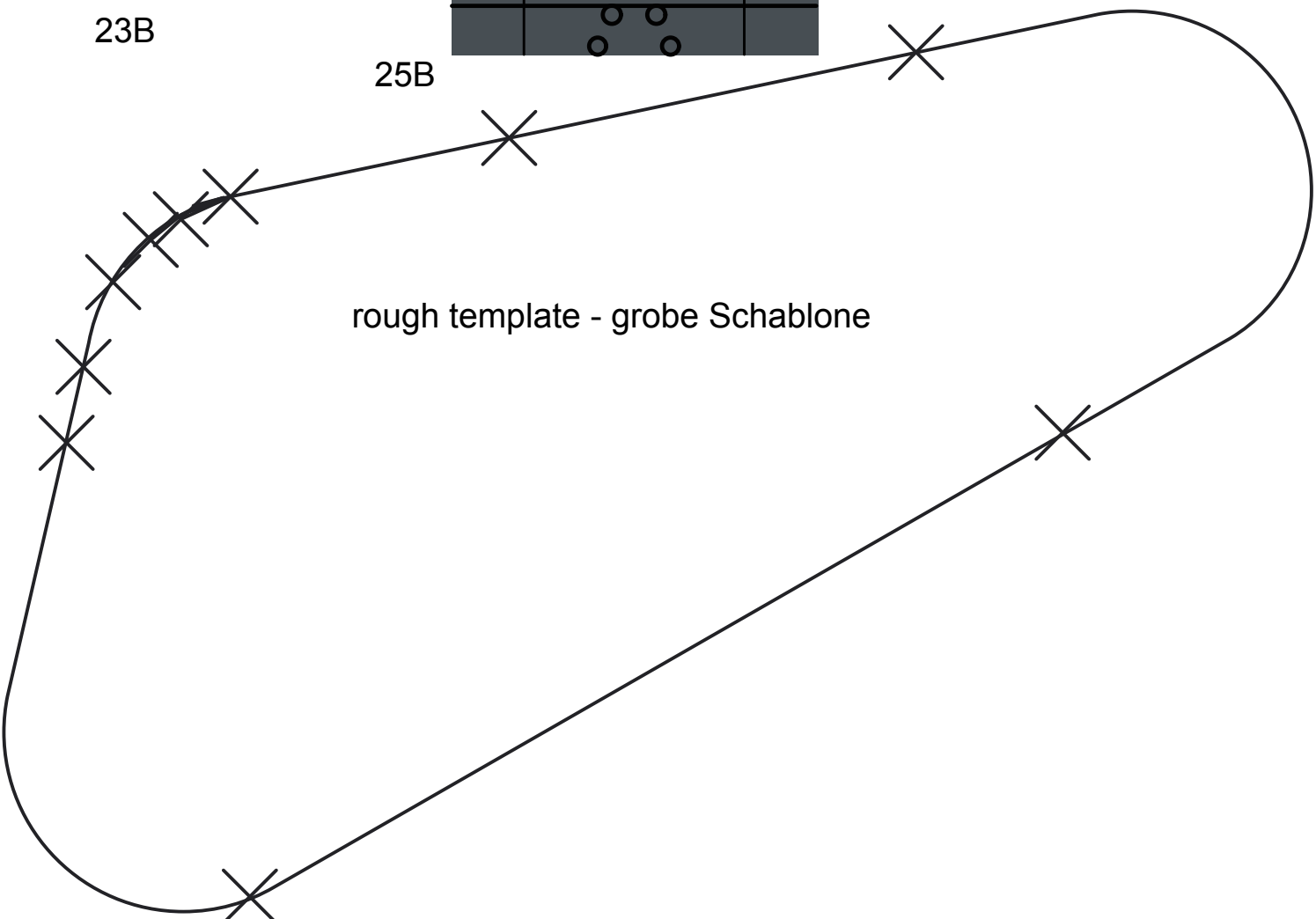

rough template - grobe Schablone

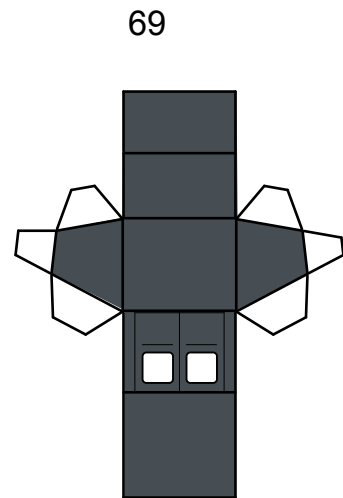
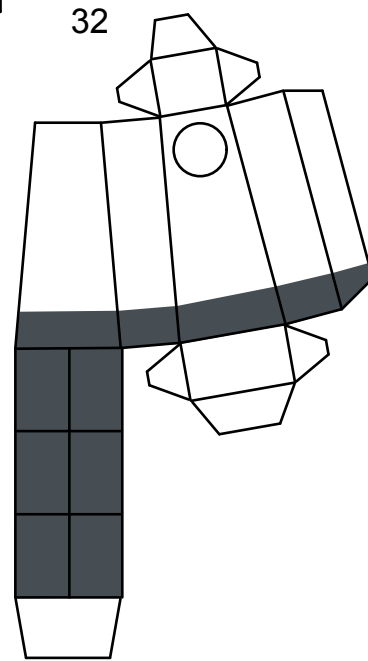
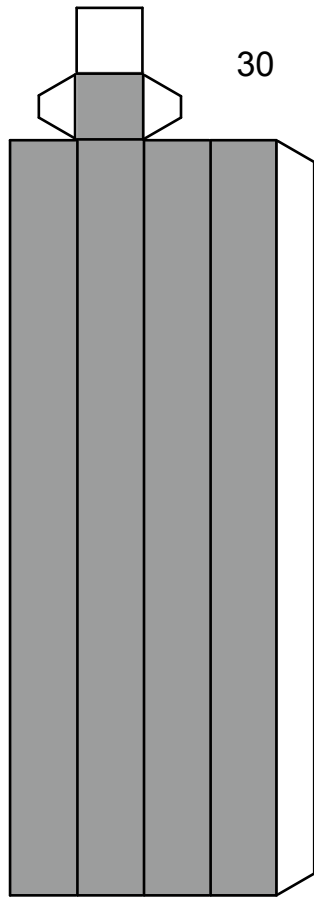
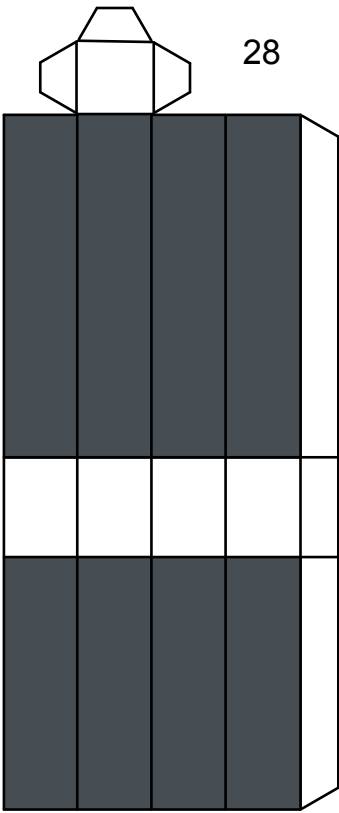
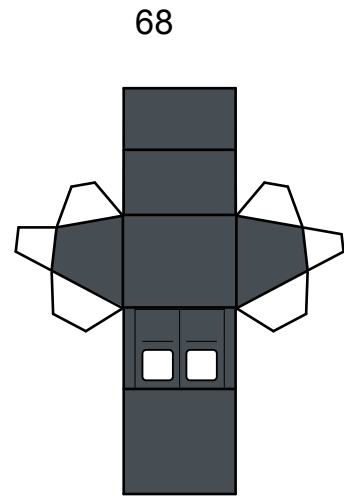
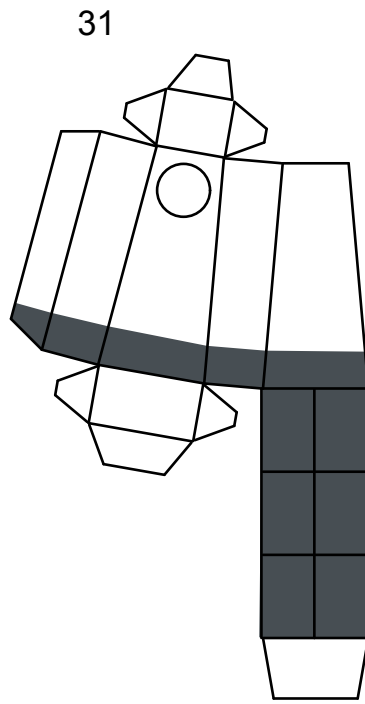
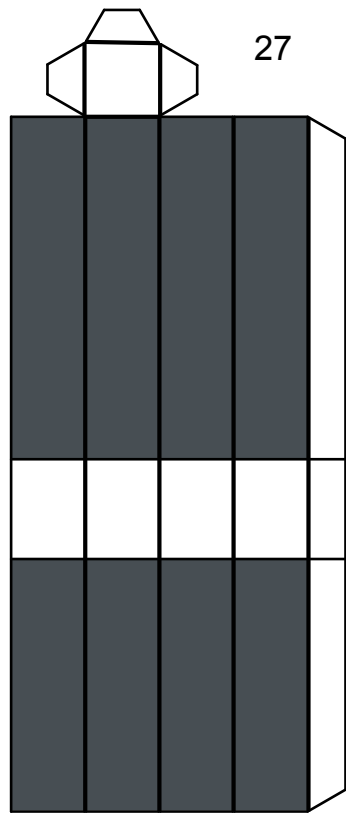
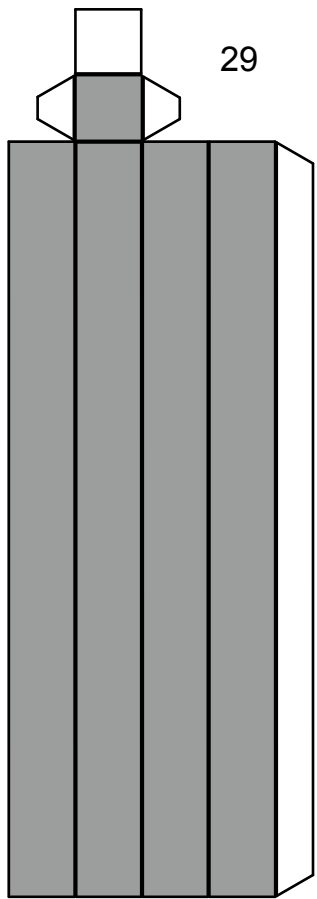

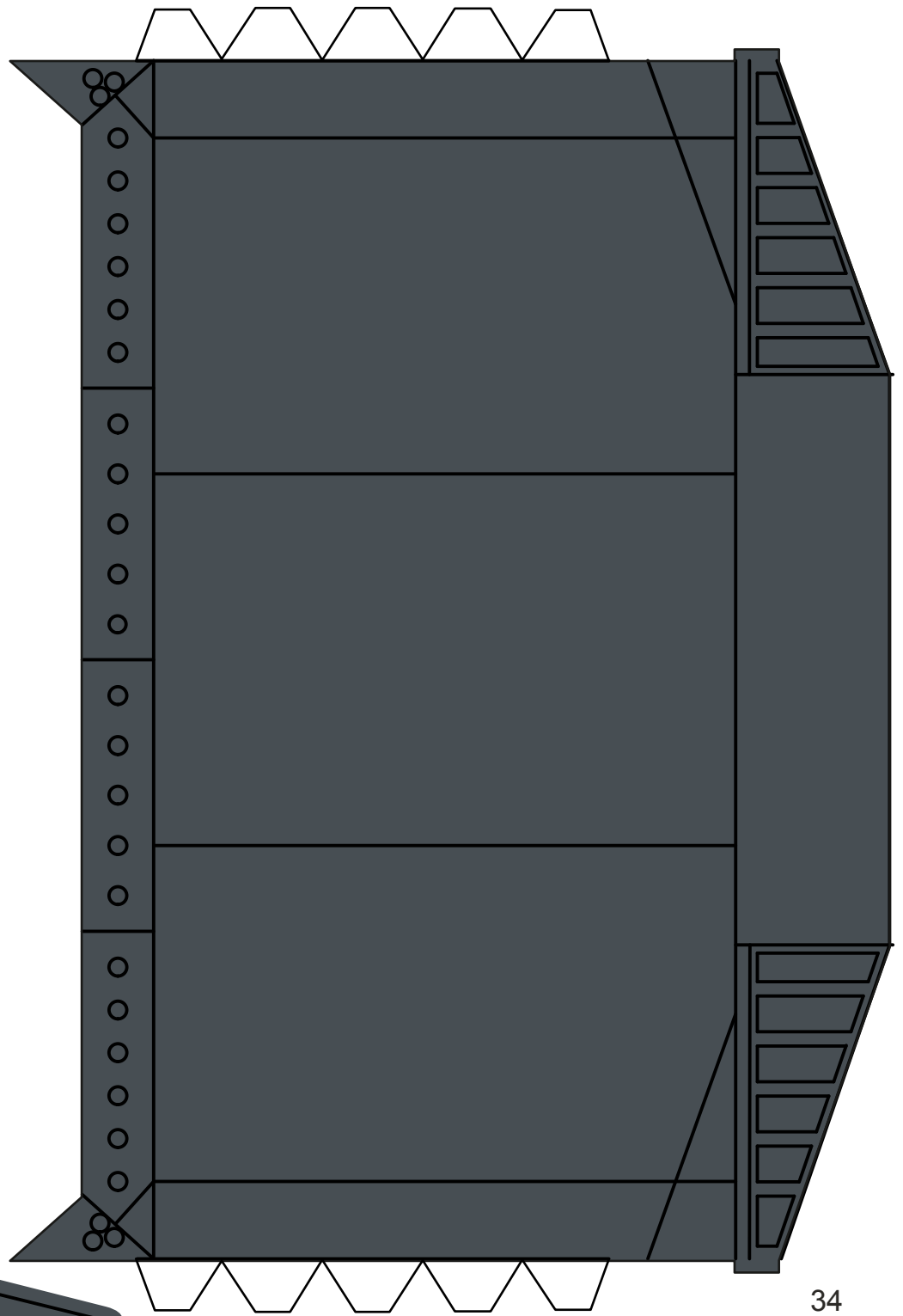

34

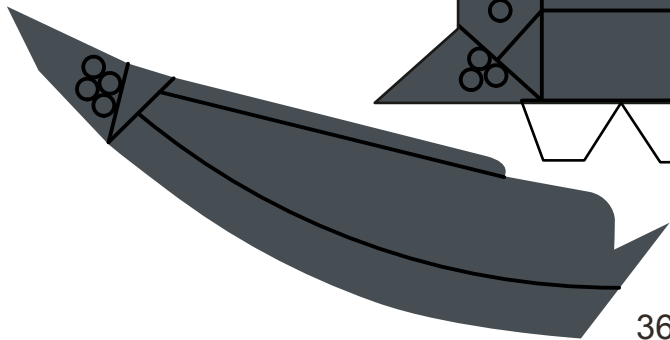

36

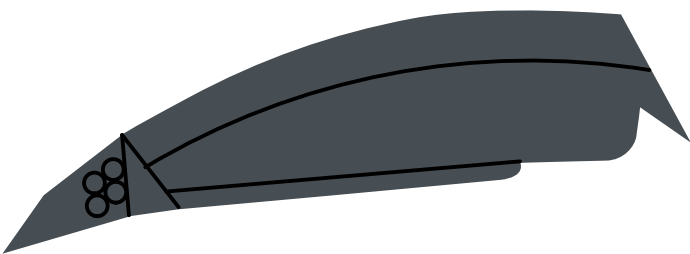

37

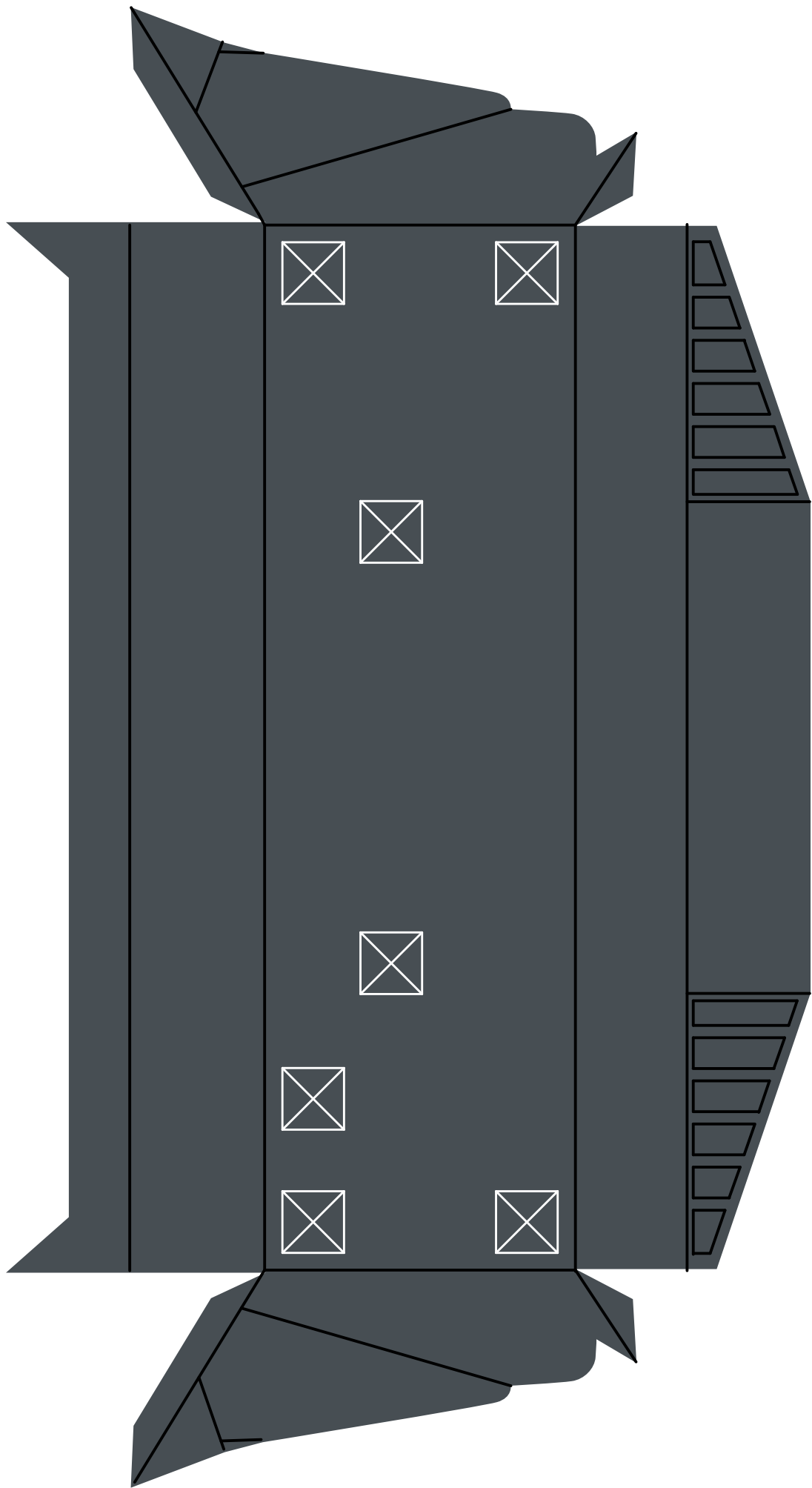



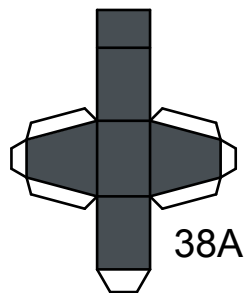
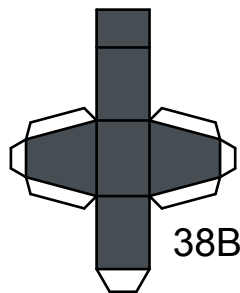
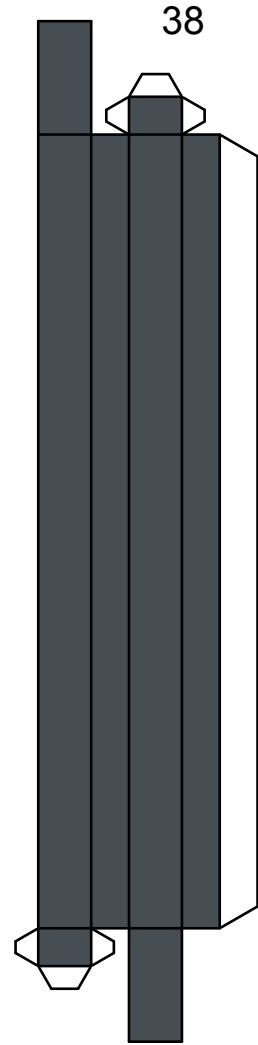
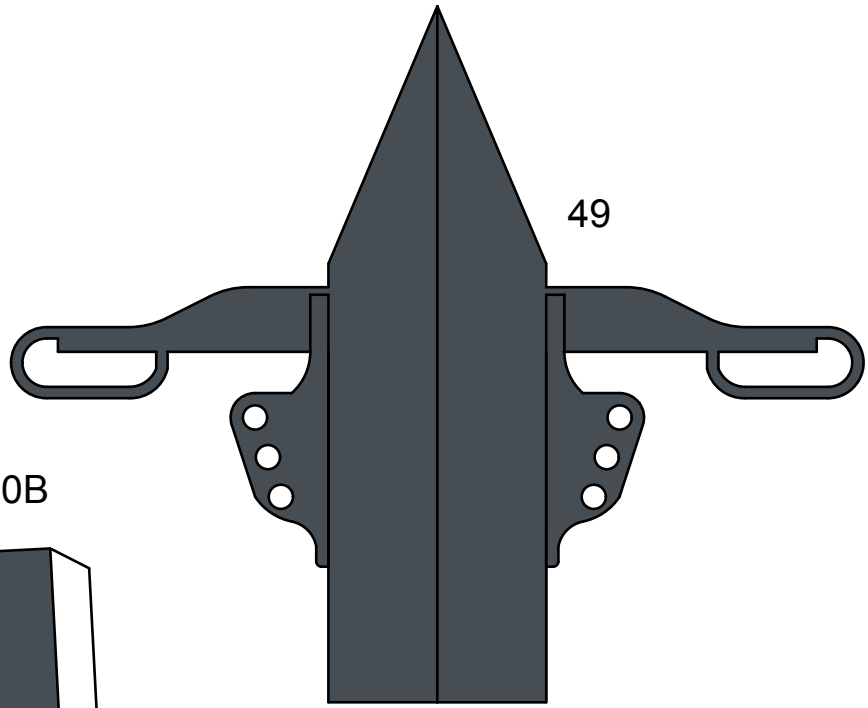
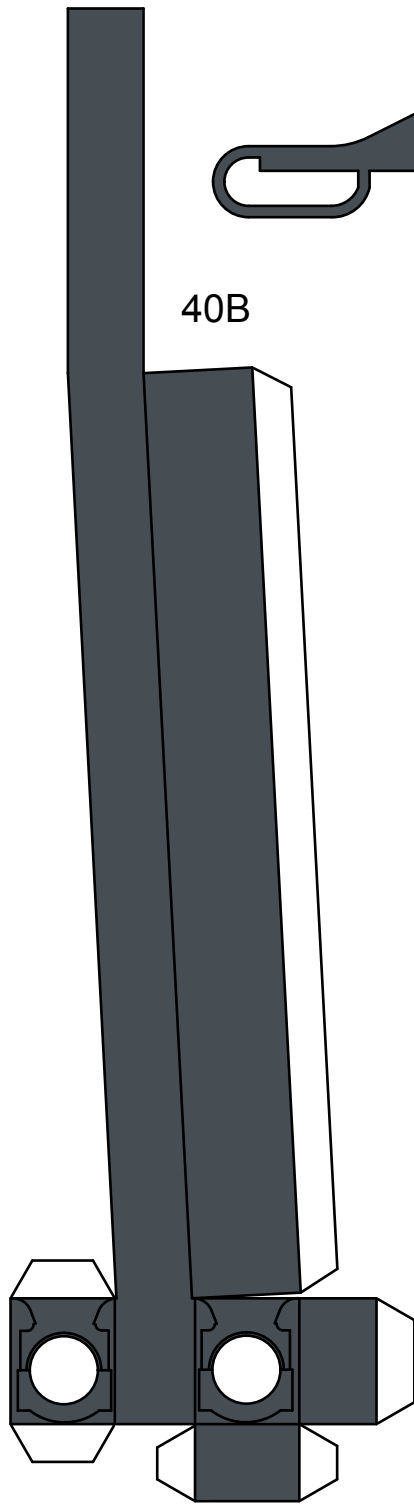
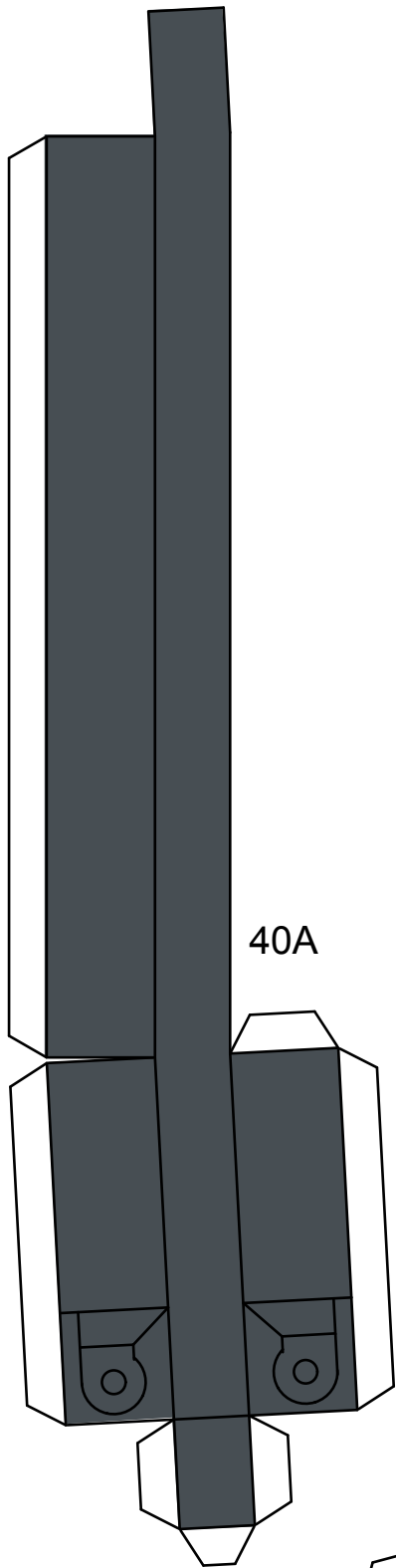

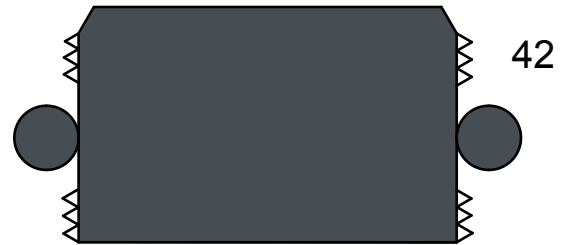
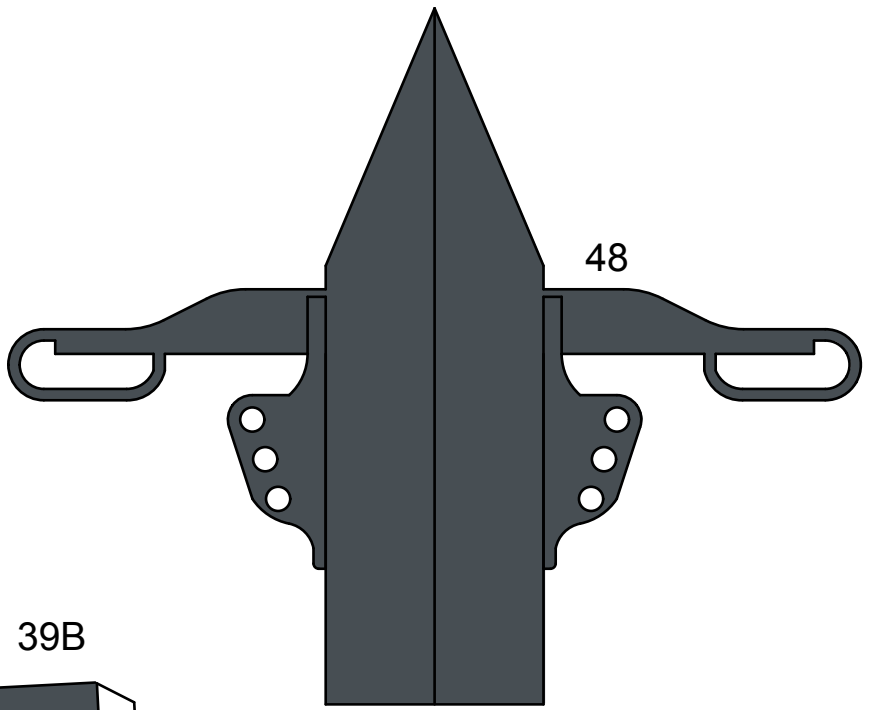
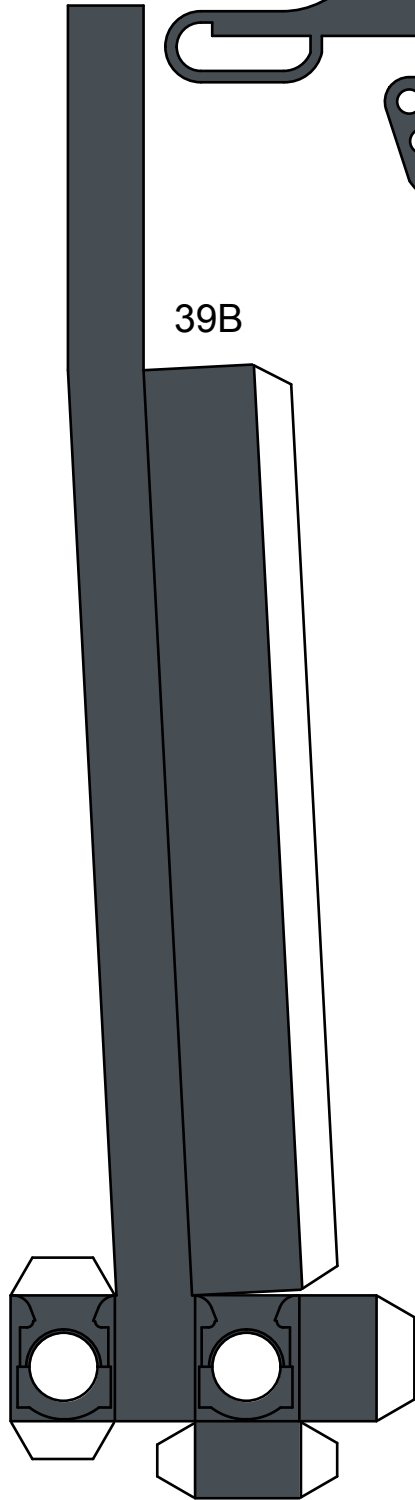

45

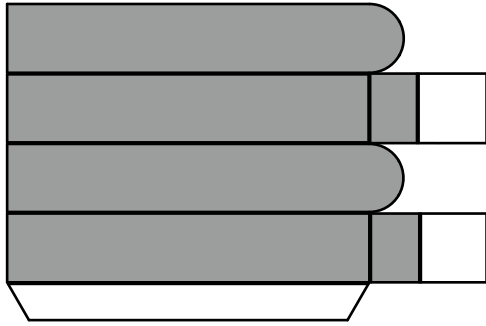

43

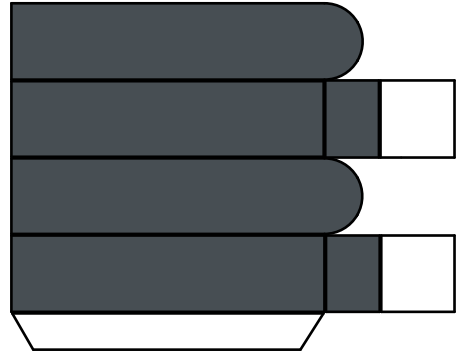

46

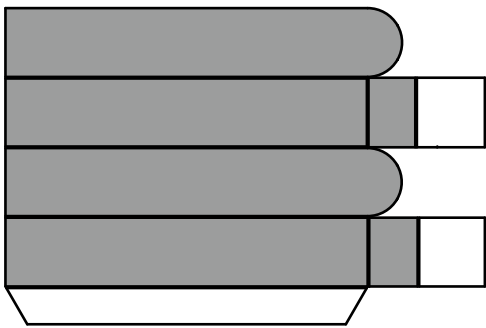

44

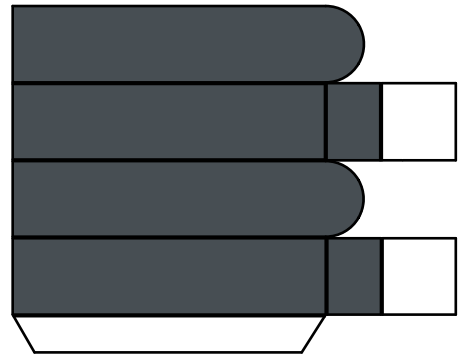

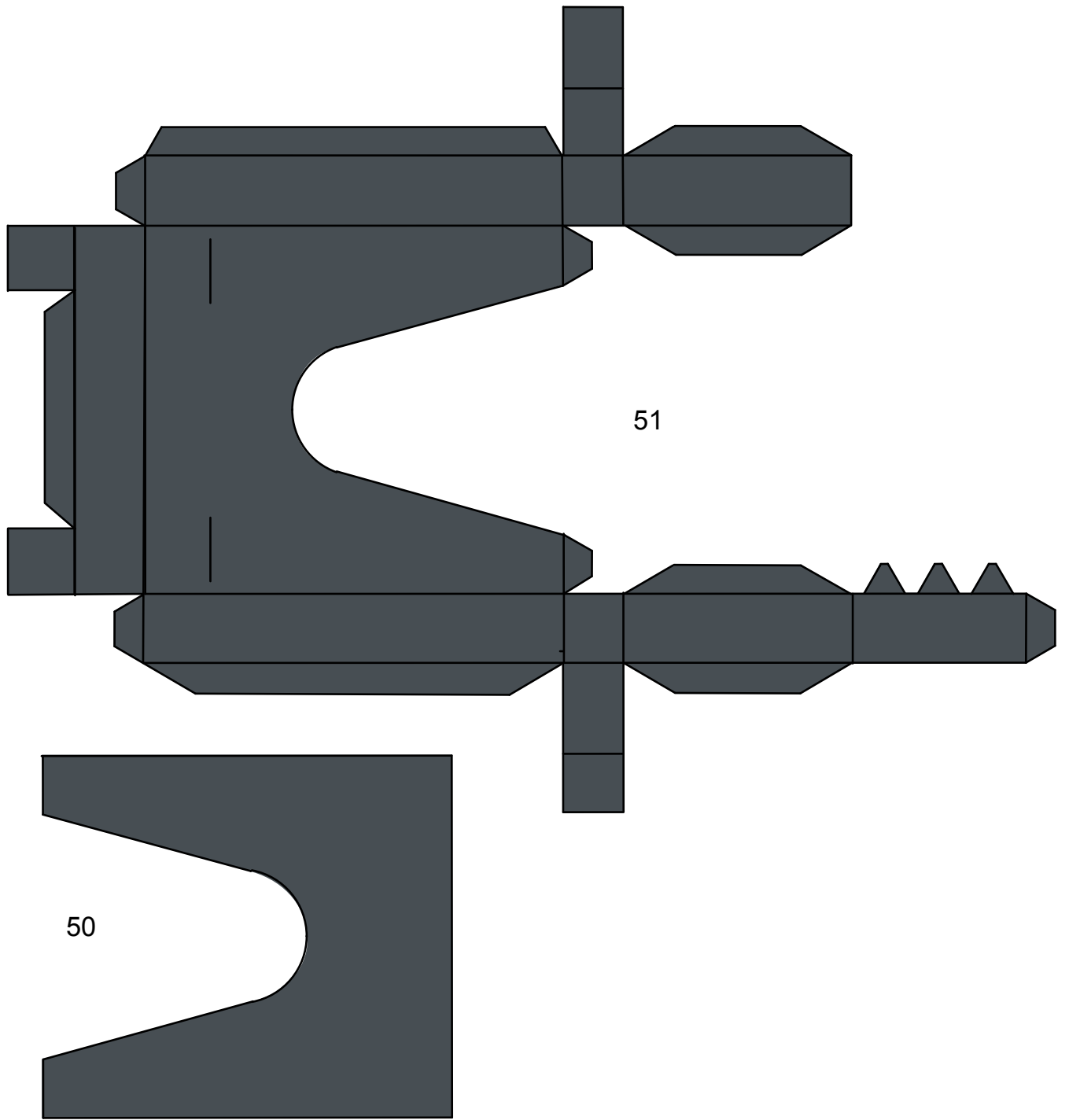

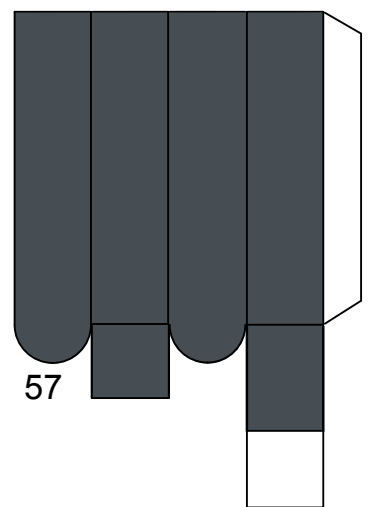
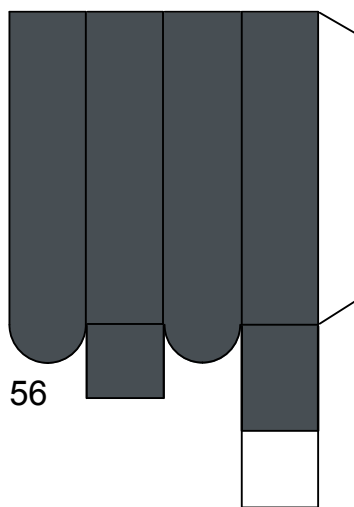
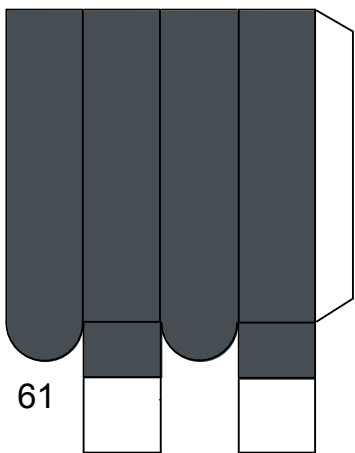
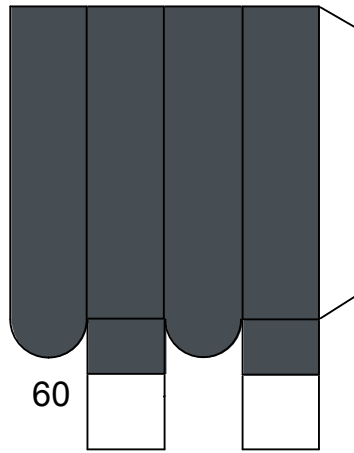
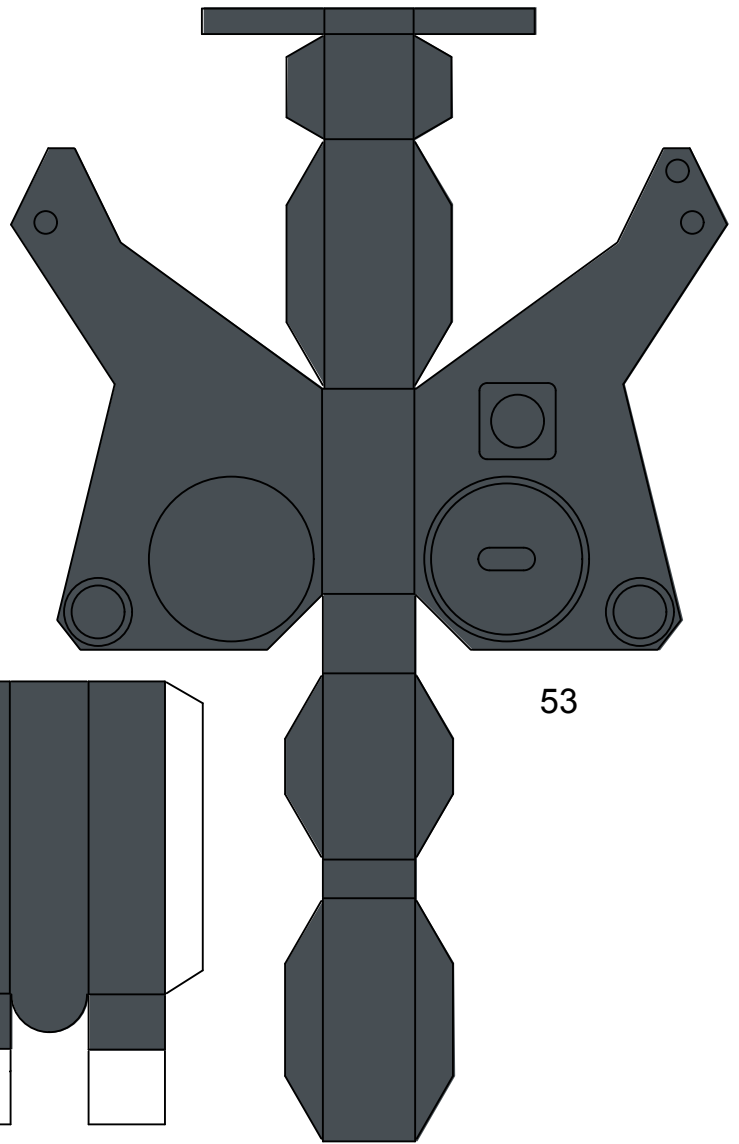
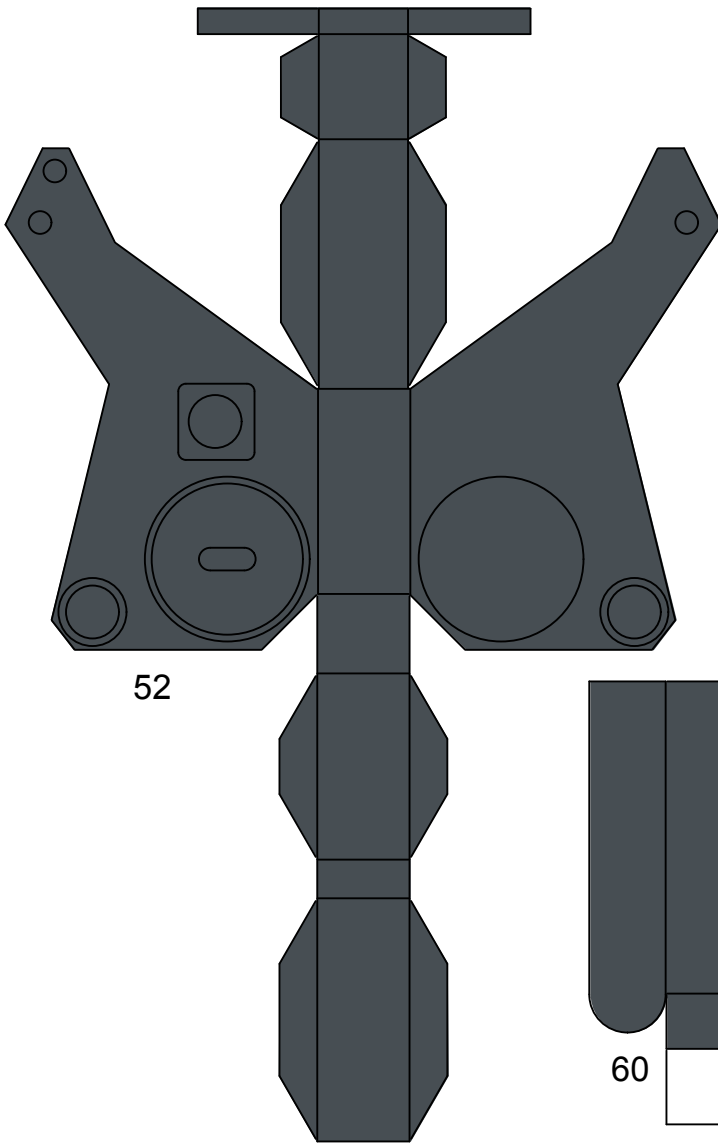

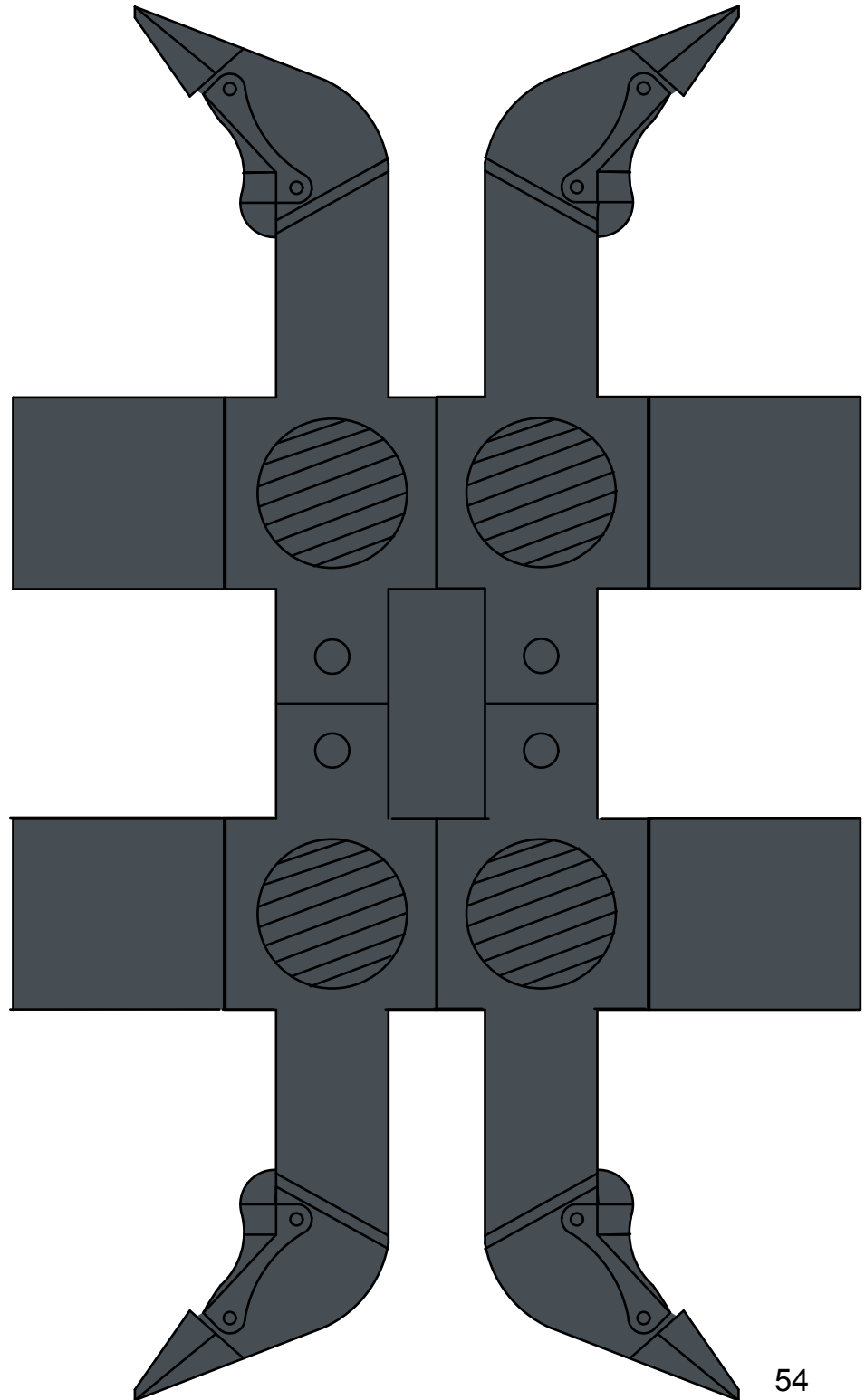
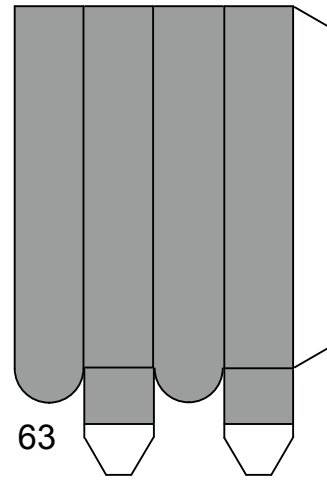
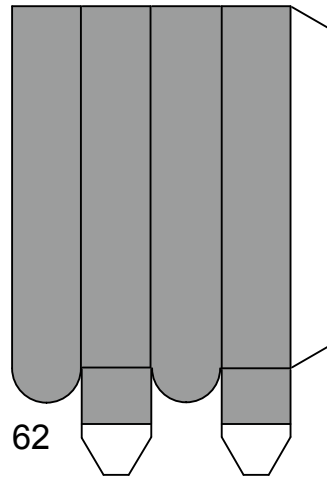
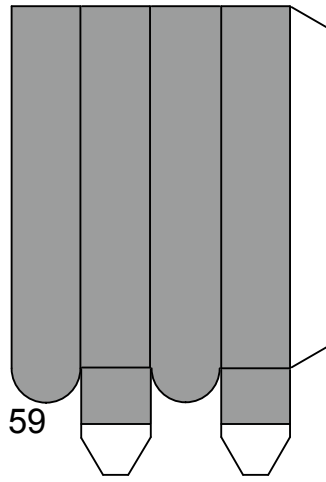
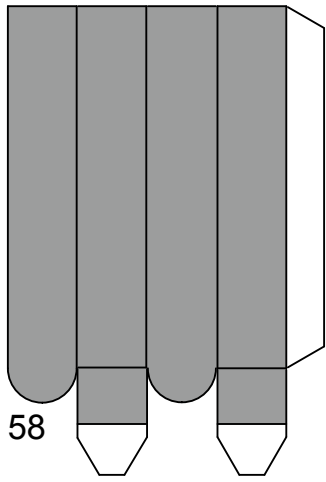

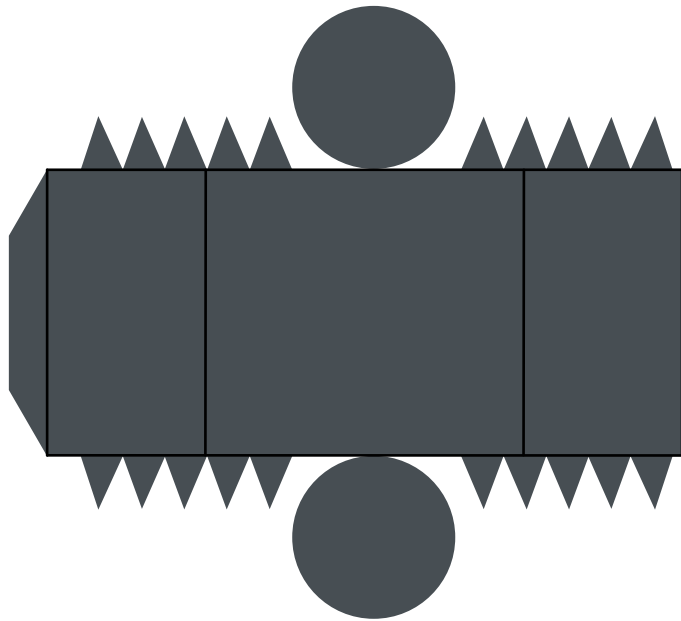
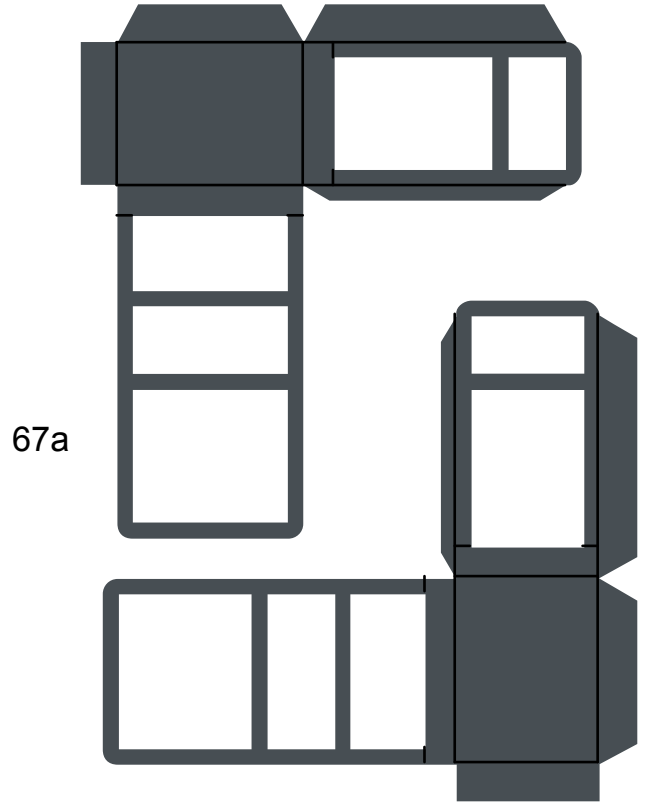
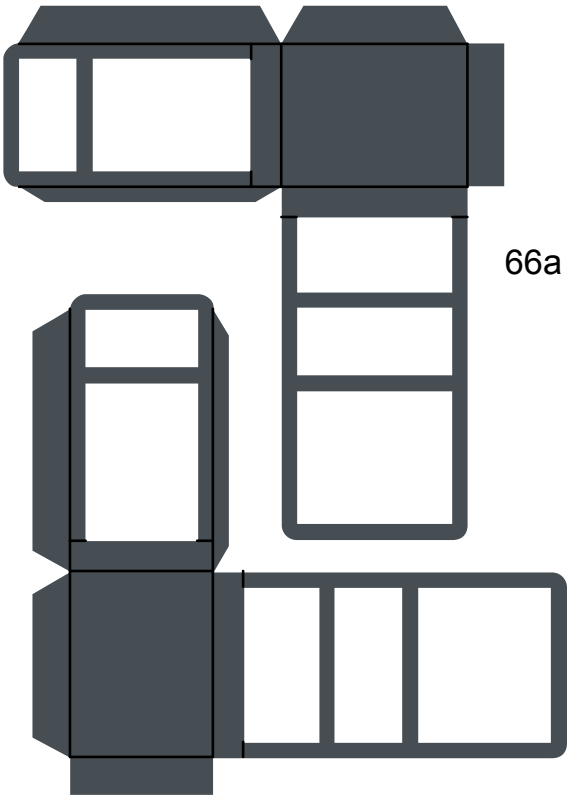

64a

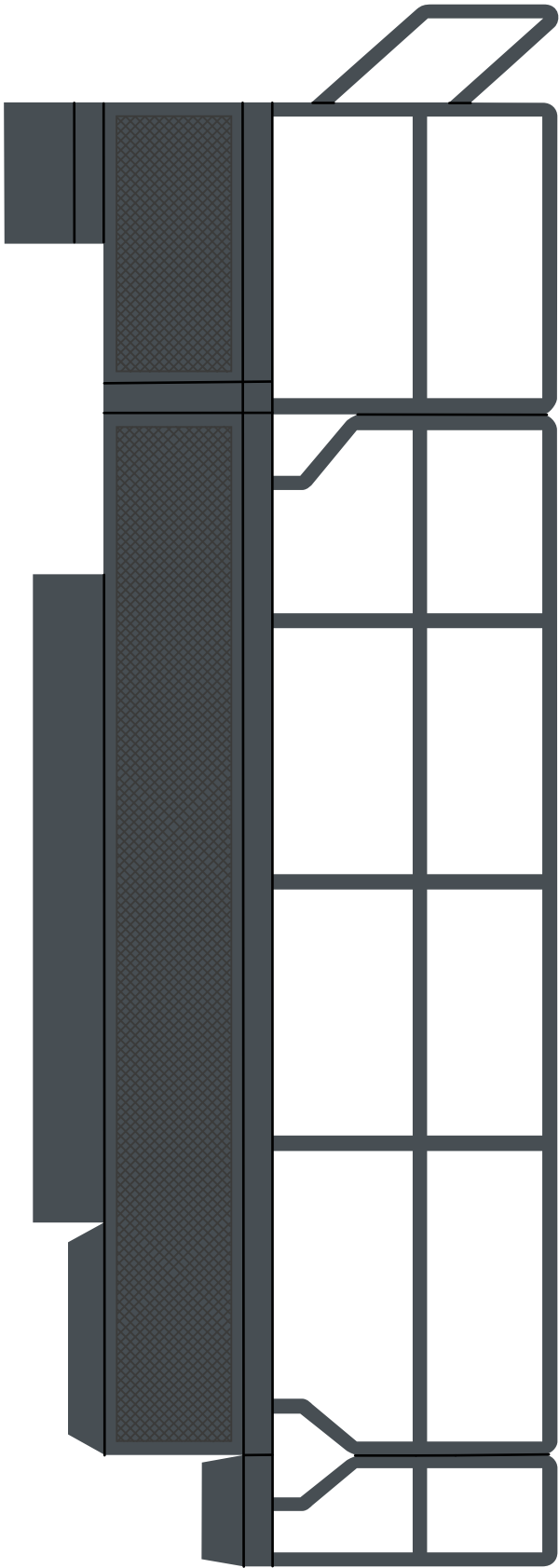

65a

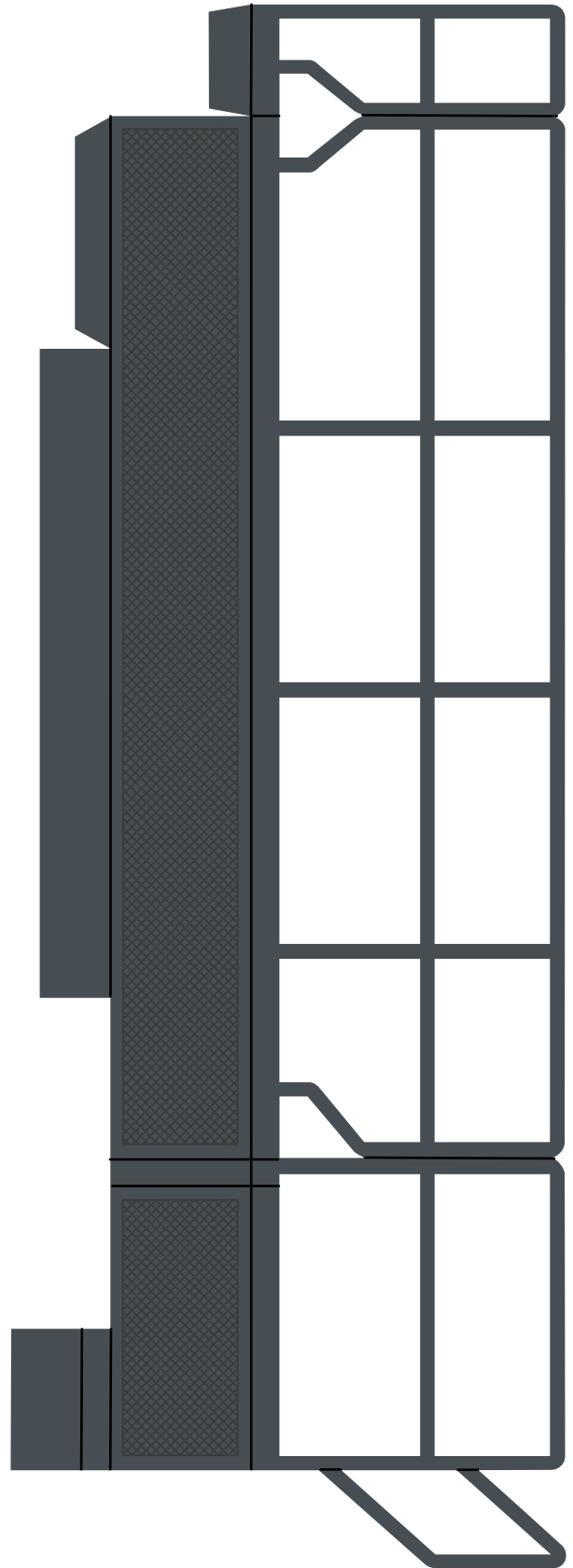



65

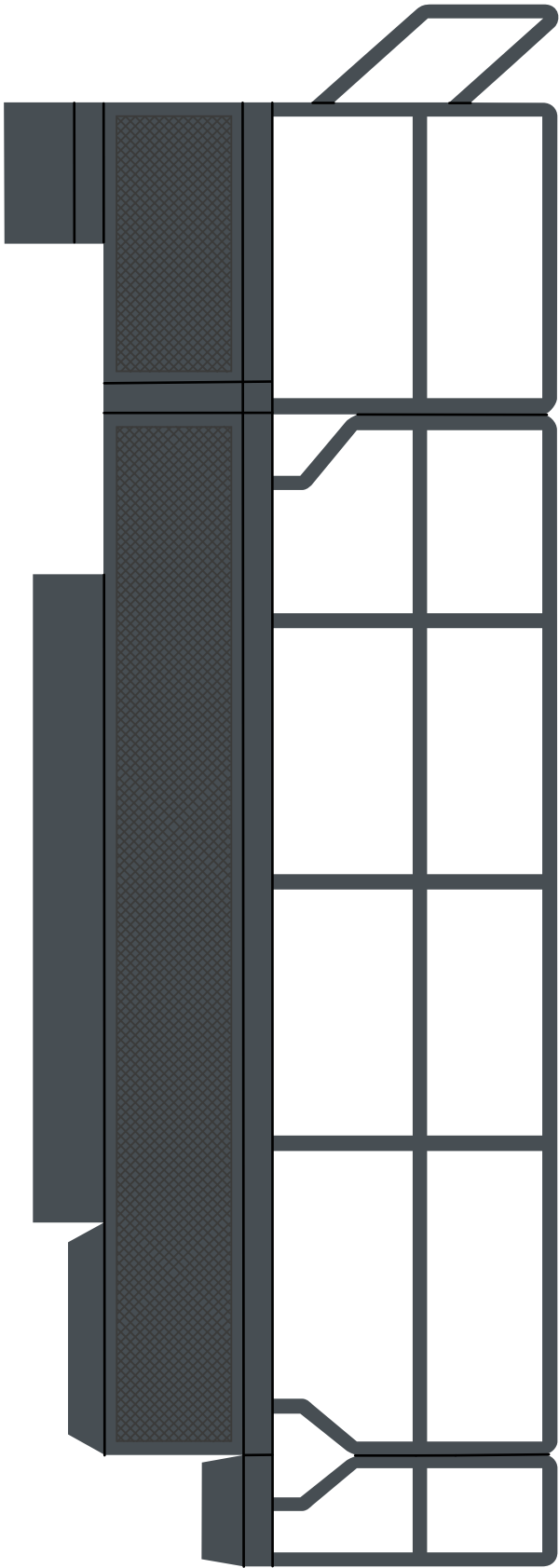

64

