Extraction where others have long since given up

LR 626 G8 – LR 636 G8

LIEBHERR

Crawler loaders



Operating weight

16,460–19,360 kg
21,690–23,047 kg

Engine output

110 kW / 150 HP
135 kW / 184 HP
Stage V / Tier 4f

Performance

Outstanding handling capacity and quick work cycles

Efficiency

Cost efficiency comes standard

Reliability

Robust design in every regard

Comfort

Ample space, ergonomics and comfort – all in one

Maintainability

Simple maintenance and an extensive service network





LR 626 G8 Litronic

Engine (ISO 9249)

110 kW / 150 HP

Tier 4f / EU Stage IV

Operating weight

16.460–19.360 kg / 36,288–42,681 lb

Bucket capacity

1,50–1,80 m³ / 1.96–2.35 yd³

Hydrostatic travel drive

with electronic control unit

Engine (SAE J1349)

110 kW / 150 HP

Tier 4f / EU Stage IV

LR 636 G8 Litronic

Engine (ISO 9249)

135 kW / 184 HP

Tier 4f / EU Stage IV

Operating weight

21.690–23.047 kg / 47,818–50,810 lb

Bucket capacity

1,90–4,60 m³ / 2.5–6.0 yd³

Hydrostatic travel drive

with electronic control unit

Engine (SAE J1349)

135 kW / 184 HP

Tier 4f / EU Stage IV

Performance



Outstanding handling capacity and quick work cycles

Power, agility and innovation are the hallmarks of Liebherr crawler loaders. Whether for moving material, pushing or grading, the Generation 6 of Liebherr crawler loaders offers powerful machines for every application.

High productivity

Powerful engines ...

Liebherr diesel engines are designed for the harsh conditions of construction sites and provide the right amount of power in every situation. Depending on the job requirements, different operating modes are available for maximum power or fuel-saving operation.

... and an intelligent drive system

The hydrostatic travel drive operates smoothly and automatically adjusts the working speed to the required traction. The engine's power is always transmitted to both tracks without interruption. This permits exact and powerful steering; track slip is minimized and operators can concentrate completely on their work.

Quick work cycle and high tipping load

The ability to change direction rapidly combined with quick loading cycles guarantees short cycle times and increased productivity. The high tipping load also ensures an impressive level of stability, e.g. when loading trucks.

Precise control

Excellent maneuverability

When handling materials in a confined space, the hydrostatic travel drive offers an additional benefit. All steering motions – including turning on the spot – are fast and effortless.

“LUDV” hydraulic control block

Load-Independent Flow Distribution: this technical innovation of Load Sensing into the LUDV-system provides greater sensitivity for the operation of the lift frame. It allows the harmonized execution of concurrent movements, such as simultaneously raising and tipping the bucket. Power adaptation on demand (Load Sensing) continues to be guaranteed.

The “All-purpose machine”

Whether it is extensive landscaping, straightforward materials handling, heavy dozer operation, grading service or ripping operations – Liebherr crawler loaders can always be used for a wide variety of applications.

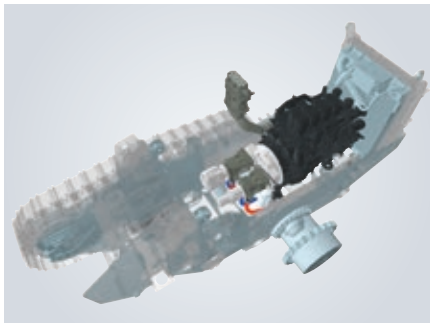

Liebherr hydrostatic drive

- Automatic speed and torque adjustment continuously optimizes transmission of engine power to the tracks as the load changes. This results in maximum traction with minimum track slip
- The advantages of the drive are particularly revealed in heavy dozing and loading operation

Intelligent engine control

- The electronically modelled power and torque curves ensure outstanding pulling power and a dynamic response to increasing loads
- On-demand power boost assures adequate power reserves, even under the most difficult working conditions

Powerful operating equipment

- Solid Z-kinematics design provides very high break-out forces
- LUDV-system: optimized hydraulic technology for quicker loading cycles and a high bucket fill level ensure increased productivity

Efficiency



Cost efficiency comes standard

Liebherr crawler loaders are specifically designed for profitability. A highly efficient drive concept, a long service life for components and minimal maintenance efforts keep operating costs down, and increase your returns.

Unrivalled economy

The latest engine and exhaust technology

The newest generation of Liebherr diesel engines complies with Emission Stage V / Tier 4 final. Liebherr-SCR technology: the exhaust gas undergoes selective catalytic reduction through injection of urea (DEF, AdBlue®). A diesel particulate filter is not required. As a result, the engine operates in a temperature range of maximum efficiency. The constant, low engine speed, in combination with Common-Rail injection, ensures optimized cylinder charging and, in turn, even more efficient fuel combustion.

Highly efficient driveline

The high efficiency of the hydrostatic drive extends over almost the entire speed range. In combination with the intelligent working hydraulics, the engine's power is transmitted with maximum efficiency and fuel consumption is minimized.

Lower CO₂ emissions

With exhaust emission values that comply with the most stringent legislation and even greater fuel economy than that of previous models, the Liebherr LR 636 crawler loader sets new standards for environmental friendliness. The "ecological footprint" is smaller than ever.



Eco-mode

- The selectable Eco-Mode reduces the engine speed at the press of a button and additionally lowers fuel consumption. Ideal for medium and light weight duty
- If the machine idles for an extended period of time, the engine can shut down automatically and avoid wasting fuel needlessly (optional)

Optimized for every job

Wide variety of equipment

The variety of front and rear equipment ensures the perfect configuration for every application: standard bucket, 4-in-1 bucket, waste handling bucket, rear ripper, winch and draw-bar are all available.

Undercarriage with rotary bushings

As the perfect feature when working on very abrasive ground, Liebherr offers a track assembly with free-turning bushings (FTB). The large, free-turning bushings minimize track and sprocket wear; in addition, chain links and rollers have even more wear material. This extends the service life of the entire track assembly considerably in these specific applications.

Equipment for special applications

Applications such as handling of waste materials place major demands on the versatility and toughness of the machines. Specially developed equipment kits ensure maximum efficiency and a long service life, even under these harsh operating conditions.



LR 636 landfill kit

- Liebherr offers a fully equipped variant of the LR 636 for use on landfills
- Many components have been developed especially for use on landfills and provide optimum protection as well as long service life



Always informed with LiDAT

- The Liebherr LiDAT data transmission and positioning system contributes to effective fleet management
- Utilizing the latest communication technology, LiDAT provides extensive information on machine operation and in this way ensures economical management, optimized service call scheduling and remote monitoring

Reliability



Robust design in every regard

Today's construction sites require machines with maximum versatility and ruggedness. Crawler loaders from Liebherr meet these requirements in an ideal manner: Thanks to components designed specifically for construction machinery, proven technology and innovative customer-specific solutions, you can expect maximum availability.

Liebherr driveline

Long-lasting engines

Diesel engines from Liebherr have powered construction machinery around the world for decades. Developed for the harshest operating conditions, their rugged construction and low nominal operating speed guarantee maximum reliability and a long service life.

Wear-free drive concept

The proven Liebherr hydrostatic travel drive, with its high performance hydraulic pumps and engines, operates virtually free of wear. Based on over 30 years of experience in crawler loaders, this drive concept also offers the highest level of reliability.

Long-lasting final drives

The large final drives used in the Liebherr crawler loaders are extremely robust and designed for the heaviest loads. Double mechanical seals with monitoring for leaks ensure reliable operation.

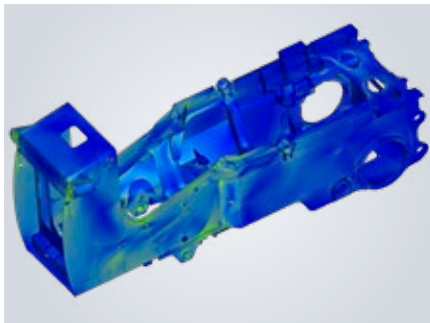

From the screen to the construction site

- Optimized layout: Components are analyzed with the aid of the latest development software as early as the design phase
- Extensive test bench runs are the next important step in the development process
- Long-term field tests under rigorous test conditions ensure maximum machine availability

Key technologies from Liebherr

- Liebherr has decades of experience in developing, designing and manufacturing components and, as a result, offers maximum reliability
- Important key components such as diesel engines, distribution gearboxes, hydraulic cylinders, final drives and electronics are manufactured in our own facility, optimized for combined operation and represent the highest quality

Rugged design

Main frame with proven box-section design

The main and track roller frames are constructed in a proven box-section design which provides maximum torsional resistance and optimal absorption of forces. Components subjected to high loads are manufactured from cast steel.

Optimized equipment

The lifting frame's tough Z-kinematics and the hard-wearing buckets are made of high-grade steel to ensure machine reliability and durability. The design is low-maintenance as bearing points are accessible from ground level. The generously dimensioned ripper is ideal and highly effective even in heavy-duty applications, making the Liebherr crawler loaders the ultimate all-rounder on the construction site.

An intelligent cooling system

A hydraulically driven fan is activated on demand to regulate the operating temperature independently of the engine's speed. This guarantees short warm-up times and reliable cooling – even in extremely dusty surroundings. A reversible fan is available for machines operating in special applications.



Liebherr lubricants and operating fluids

- Nowadays lubricants are considered to be a design element and are therefore a major component of all modern construction machines
- Liebherr offers an extensive range of high quality lubricants and operating fluids. These are designed specifically for use in Liebherr machines and ensure excellent durability for all components with the lowest possible operating costs

Comfort



Comfort, space and ergonomics: All in one

The working area in the generation 6 Liebherr crawler loaders is characterized by the exceptional level of comfort offered to the operator. Comfort is provided by the generous space, ergonomic layout, quiet and with the best possible visibility, the Liebherr comfort cab provides the ideal conditions for concentrated work, without fatigue.

Deluxe cab

Ergonomic and purposely designed

The well-thought-out design of the operator's cab provides the best conditions for relaxed and productive work. All instruments and operating controls are organized logically and ergonomically, and are easily reached. An unobstructed view of the work equipment and perfect all-round visibility allows the operator to concentrate fully on the task at hand.

Convenience in daily use

Carefully considered details such as adjustable armrests, a variety of stowage options, a cooled storage compartment and a powerful air conditioning system improve the operator's comfort and boost daily productivity.

Quiet and dust-free

Thanks to effective sound insulation and modern, low-noise diesel engines, the Liebherr crawler loaders features exemplary noise levels that lie well below the legal limits. The pressurized cab keeps the operator's environment free of dust from the surroundings.



Individual set-up

- The intuitive touch-screen display continuously provides all important operating data
- At the same time, the display screen also serves as a monitor for the reversing camera
- At the push of a button, the operator can adjust a wide variety of machine settings – e.g., the response of the travel drive – precisely to his needs

Simple and intuitive operation

Single-lever control

All driving functions can be controlled smoothly and precisely with only one operating lever – including the “turning on the spot” function. The travel joystick is optionally available in either a proportional or “V-lever” version including foot-pedal steering – this allows control to be matched optimally to the needs of the operator.

Safety-plus comfort seat

The standard air-sprung seat adjusts perfectly to the operator and deactivates the machine automatically on exiting the cab.

The hydrostatic drive as service brake

The crawler loader never loses traction even when driving on slopes. Thanks to the self-locking nature of the hydrostatic drive system, the operator can bring the machine to a stop at any time simply by bringing the joystick to the “neutral” position. An automatically activated parking brake provides additional safety.



Visibility = safety

- The reversing camera comes standard and increases the operator's field of vision and enhances safety on the construction site as well as helping to improve productivity when using the ripper
- The camera is permanently active and when reversing, the image can be selected in either small or large format



Panoramic windows

- A plus for safety and productivity: the front screen extends a long way down to give the best possible view of the working equipment
- The cab's integrated ROPS/FOPS protection also ensures unmatched all-round visibility

Maintainability



Simple maintenance and an extensive service network

Thanks to their minimal maintenance requirements, Liebherr crawler loaders make a reliable contribution to your economic success. A dense service network means short distances, efficient structures and fast service response times for the user.

Cost-effective maintenance

Simple daily checks

All items that the operator checks during daily routine inspections are readily accessible on one side of the engine. The hydraulically tilted cab comes as standard and provides easy access to components as well. Service work can be performed quickly and efficiently.

Long maintenance intervals

The maintenance intervals are optimally matched to the individual components. Maintenance-free mountings are often used in exposed areas. Hydraulic oil change intervals of up to 8,000 operating hours reduce costs and minimize downtime.

Optimal planning

Planned costs

Liebherr crawler loaders come with extensive standard warranties for the entire machine and the drive train. Customized inspection and service programmes allow optimal planning of all maintenance activities.

Remanufacturing

The Liebherr remanufacturing program offers cost-effective reconditioning of components to the highest quality standards. Various reconditioning levels are available: Replacement components, general overhaul or repair. The customer receives components with original part quality at a reduced cost.

The focus is on the customer

Qualified advice and service

Competent advice is given at Liebherr. Experienced specialists provide adequate guidance for your specific requirements: application-oriented sales support, service agreements, value-priced repair alternatives, original parts management, as well as remote data transmission for machine planning and fleet management.

Continuous dialogue with users

We utilize the expert knowledge and practical experience of our customers to consistently optimize our machines and services – real solutions for real situations.



Easy access

- All service points are centrally located and easily accessible. Thanks to wide-opening access doors, the daily inspection of the machine is simple and time-saving
- The standard lighting of the engine area simplifies maintenance and inspection

Tilt-out cooling fan

- In especially dusty applications, the standard swing-out fan contributes significantly to easy cleaning of the radiator system. The HD radiator grille requires no tools to open

Rapid spare parts service

- 24-hour delivery: Spare parts service is available for our dealers around the clock
- Electronic spare parts catalogue: Fast and reliable selection and ordering via the Liebherr online portal
- With online tracking, the current processing status of your order can be viewed at any time

Technical data LR 626



Diesel engine

Liebherr diesel engine	D 924-A7 Emissions limits in accordance with 97/68/EG, 2016/1628/EU Stage V, EPA/CARB Tier 4 Final
Nominal power (net) ISO 9249 SAE J1349	110 kW / 150 hp 110 kW / 147 hp
Maximum power (net) ISO 9249 SAE J1349	125 kW / 170 hp 125 kW / 167 hp
Rated engine speed	2,100 1/min.
Displacement	4.5 l / 1.19 gal
Bore / stroke	104 mm (4.1 in) / 132 mm (5.2 in)
Model	4 cylinder in-line engine, water-cooled, turbocharger, air-to-air intercooler
Fuel injection system	Direct injection, Common Rail, electronic control
Engine lubrication	Pressurised lube system, for inclinations up to 40°
Operating voltage	24 V
Alternator	140 A
Starter	5.5 kW / 7.37 hp
Batteries	2x180 Ah / 12 V
Air filter	Dry-type air cleaner with under pressure indicator and automatic dust ejector, main and safety elements
Cooling system	Combination cooler, with single cooling units for water, hydraulic fluid and intake charge air
Cooling fan	Hydrostatically driven fan with thermostatic control



Hydraulics

Hydraulic system	Load-sensing demand control
Pump type	Variable displacement pump in swashplate design
Flow max.	189 l/min. / 49.9 gpm / 41.6 Imp. gpm
Pressure relief	250 bar / 3.625 psi
Filter system	Return filter with magnetic rod in hydraulic tank
Control	Single joystick for all movements of the loading bucket and 4 in 1 bucket; control of the floating position lift and lower shutoff and bucket return



Travel drive, control

Transmission system	Infinitely variable hydrostatic travel drive, consisting of 2 axial piston variable displacement pumps and 2 axial piston variable displacement motors in swashplate design, independent drive for left and right track
Travel speed	Infinitely variable electronic speed control, V-max adjustable via step switch on the throttle (V1, V2, V3) 2.5- 6.0 km/h (1.6-3.7 mph) 4.0- 8.0 km/h (2.5-5.0 mph) 6.5-10.0 km/h (4.0-6.2 mph)
forwards and backwards V1-max: V2-max: V3-max:	
Load limit control	The load limit control electronically monitors the speed of the diesel engine and regulates the diesel engine torque according to the required driving force
Steering	Hydrostatic, manoeuvrability up to turning on the spot (counterrotation of the tracks)
Service brake	Hydrostatic, dynamic self-locking effect
Parking / emergency brake	Multi-disc brake, wear-free, automatically applied with neutral joystick position
Cooling system	Hydraulic fluid cooler in combination cooler
Filter system	Micro cartridge filter in replenishing circuit
Final drive	Spur gear in combination with planetary gear
Control	Single joystick for all travel and steering functions, as well as turning on the spot Optional: Throttle with steering pedals



Operator's cab

Cab	Closed cab with positive pressure ventilation, can be tilted 40° using hand pump, integrated ROPS roll-over protection (EN ISO 3471) and FOPS stone chip protection (EN ISO 3449)
Heating and air conditioning	Air conditioning meets requirements according to ISO 10263, air is distributed over 12 air vents and 10 blower levels, 6 air routing modes can be set on the control panel
Driver's seat	Air-sprung comfort seat or premium seat, fully adjustable, drive and operating hydraulics control mounted on armrest Optional: Air conditioned seat cushion
Glazing	Windscreen: Laminated safety glass Optional: Polycarbonate Side window: Tempered safety glass Optional: with sliding window (individually selectable on each side) Rear window: Tempered safety glass Optional: Polycarbonate
Monitoring	Touch display: Display of current machine information, automatic monitoring of operating conditions and individual setting of machine parameters
Work lights	LED standard (1,200 lm each) 4 on the front, 2 on the rear Optional: 4 on the front, 4 on the rear LED-HD (4,200 lm each) 4 on the front, 2 on the rear Optional: 4 on the front, 4 on the rear
Vibration emission	
Hand and arm vibrations	< 2.5 m/s ² , in accordance with ISO 5349-1:2001
Whole-body vibrations	0.26-1.18 m/s ² , complies with technical report ISO/TR 25398:2006
Measuring inaccuracy	In accordance with EN 12096:1997

Undercarriage

Mounting	Cushion mounted via pivot shafts and equalizer bar
Track chains	Sealed and oil-lubricated, chain tension through compression spring and grease clamping cylinder, optional oil-lubricated sleeve chain with FTB available
Chain links on each side	38
Sprocket segments, each side	5
Track rollers, each side	6
Carrier rollers, each side	1
Track shoes, standard	508 mm / 20", double grouser
Track shoes, optional	457 mm / 18", double grouser 560 mm / 22", double grouser 610 mm / 24", double grouser 660 mm / 26", double grouser Wider track shoes available on request
Grouser height	35 mm / 1.3"

Sound levels

Operator sound exposure to ISO 6396	
L_{pA} (in the cab)	78 dB(A)
External sound power level to 2000/14/EG	
L_{WA} (to surroundings)	109 dB(A)

Refill capacities

Fuel tank	320l / 84.53 gal / 70.4 Imp. gal
Diesel Exhaust Fluid (DEF) tank	49l / 12.94 gal / 10.8 Imp. gal
Cooling system	31l / 8.19 gal / 6.8 Imp. gal
Engine oil with filter	19l / 5.01 gal / 4.2 Imp. gal
Hydraulic tank	93l / 24.56 gal / 20.5 Imp. gal
Pivot shaft, each side	4.3l / 1.14 gal
Final drive, each side	8.5l / 2.25 gal / 1.9 Imp. gal

Cycle times

Lifting	5.6 s
Dumping (maximum cylinder stroke)	1.6 s
Dumping (at maximum height)	1.0 s
Tilting back (maximum cylinder stroke)	2.3 s
Tilting back (at maximum height)	1.5 s
Lowering¹⁾	3.3 s

¹⁾ Float position and empty bucket

Drawbar pull

Maximum	195 kN
at 1.5 km/h (0.9 mph)	193 kN
at 3.0 km/h (1.8 mph)	114 kN
at 6.0 km/h (3.7 mph)	56 kN
at 9.0 km/h (5.6 mph)	37 kN

Dimensions LR 626

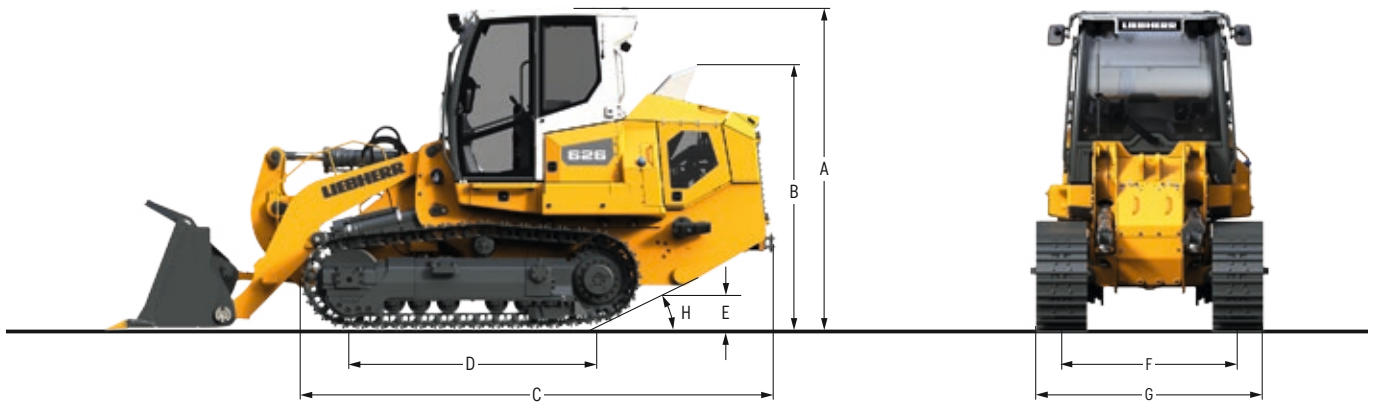

Dimensions

A Height over cab	mm	3,160
	ft in	10'4.4"
B Height over exhaust pipe	mm	2,590
	ft in	8'6"
C Length to front track	mm	4,610
	ft in	15'1.5"
D Distance idler/sprocket centre	mm	2,450
	ft in	8'0.5"
E Ground clearance	mm	420
	ft in	1'4.5"
F Track gauge	mm	1,740 ¹⁾
	ft in	5'8.5"
G Track shoes 457 mm Machine width	mm	2,197
	ft in	7'2.5"
G Track shoes 508 mm Machine width	mm	2,248
	ft in	7'4.5"
G Track shoes 560 mm Machine width	mm	2,300
	ft in	7'6.5"
G Track shoes 610 mm Machine width	mm	2,452 ²⁾
	ft in	8'0.5" ²⁾
G Track shoes 660 mm Machine width	mm	2,502 ²⁾
	ft in	8'2.5" ²⁾
H Approach angle		30°

¹⁾ Track gauge at 610 mm and 660 mm track shoes: 1,842 mm

²⁾ minimum bucket width 2,650 mm required

Front attachments LR 626

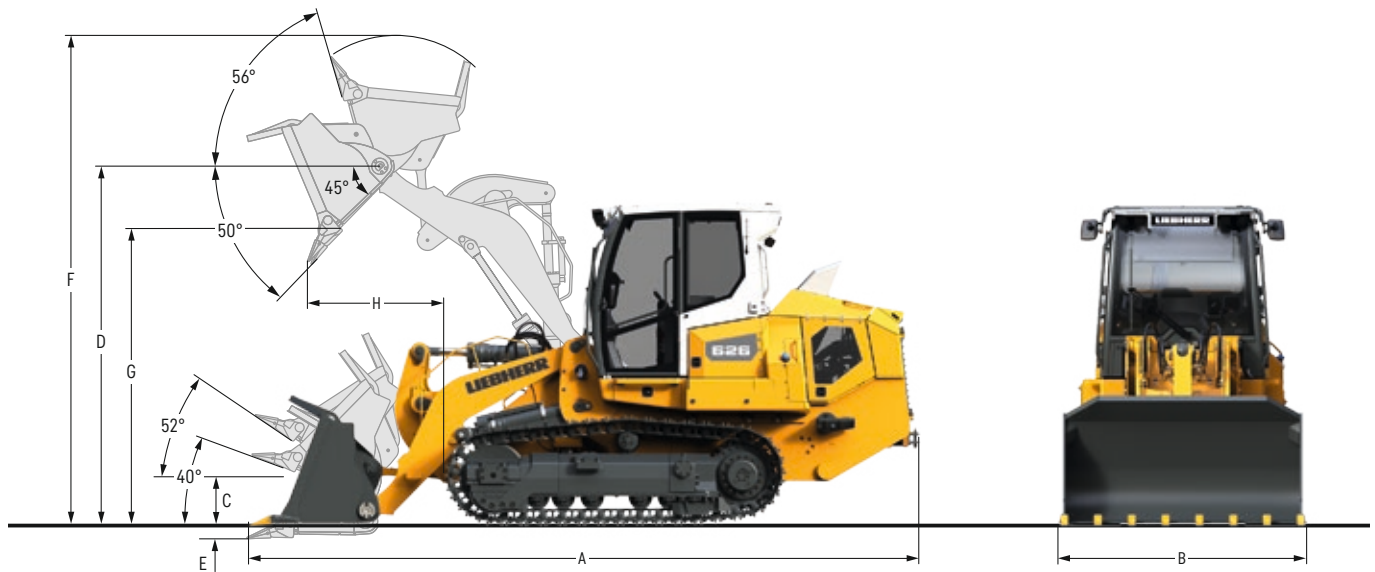

Standard bucket

Version with		Bolt-on adapters, shanks and segments	Flush weld-on adapters, shanks	Bolt-on cutting edge
Nominal rated bucket capacity, heaped, ISO 7546	m ³	1.8	1.7	1.8
	yd ³	2.35	2.22	2.35
Nominal rated bucket capacity, heaped, SAE J742	m ³	1.8	1.7	1.8
	yd ³	2.35	2.22	2.35
Breakout force, ISO 14397	kN	127	138	127
	lb	28,550	31,023	28,550
Static tipping load, ISO 14397	kg	11,519	11,752	11,619
	lb	25,395	25,908	25,615
A Overall length bucket on ground with rear bumper	mm	6,523	6,545	6,362
	ft in	21'4.8"	21'5.7"	20'10.5"
B Bucket width ²⁾	mm	2,482	2,450	2,420
	ft in	8'1.7"	8'0.5"	7'11.3"
C Height, hinge pin transport position	mm	541	541	541
	ft in	1'9.3"	1'9.3"	1'9.3"
D Height, hinge pin max.	mm	3,663	3,663	3,663
	ft in	12'0.2"	12'0.2"	12'0.2"
E Digging depth max.	mm	136	111	136
	ft in	5.4"	4.4"	5.4"
F Overall height with bucket at full lift	mm	5,007	5,007	5,007
	ft in	16'5.1"	12'0.2"	12'0.2"
G Dumping clearance at full lift and 45° tipping angle, ISO 7131	mm	2,849	2,917	2,849
	ft in	9'4.2"	9'6.8"	9'4.2"
H Reach at full lift and 45° tipping angle, ISO 7131	mm	1,051	1,018	1,051
	ft in	3'5.4"	3'4.1"	3'5.4"
Bucket weight	kg	1,219	1,090	1,119
	lb	2,687	2,403	2,467
Operating weight ¹⁾	kg	16,589	16,458	16,487
	lb	36,572	36,283	36,347
Ground pressure, ISO 16754 ¹⁾	kg/cm ²	0.59	0.59	0.59
	psi	8.56	8.56	8.56

¹⁾ Incl. coolant and lubricants, full fuel tank, ROPS/FOPS cab, operator, bucket, and track shoes with 508 mm.

²⁾ With 508 mm track shoes. With alternative track shoes on request.

Front attachments LR 626

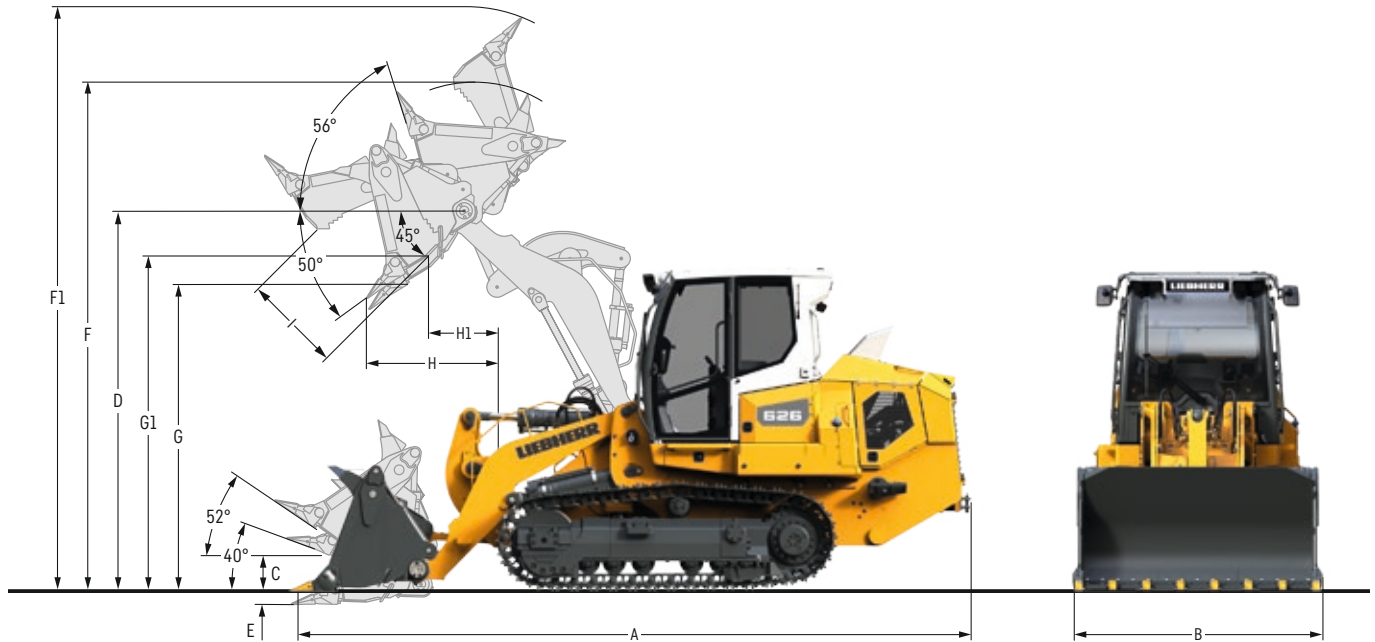

4-in-1 Multi-purpose bucket

Version with		Bolt-on adapters, shanks and segments	Bolt-on adapters, shanks
Nominal rated bucket capacity, heaped, ISO 7546	m ³ /yd ³	1.6/2.1	1.5/1.96
Nominal rated bucket capacity, heaped, SAE J742	m ³ /yd ³	1.6/2.1	1.5/1.96
Breakout force, ISO 14397	kN/lb	113/25,403	123/27,651
Static tipping load, ISO 14397	kg/lb	10,199/22,485	10,410/22,950
A Overall length bucket on ground	mm ft in	6,623 21'8.7"	6,623 21'8.7"
B Bucket width²⁾	mm ft in	2,482 8'1.7"	2,482 8'1.7"
C Height, hinge pin transport position	mm ft in	541 1'9.3"	541 1'9.3"
D Height, hinge pin max.	mm ft in	3,663 12'0.2"	3,663 12'0.2"
E Digging depth max.	mm ft in	186 7.3"	186 7.3"
F Overall height with bucket at full lift (bucket closed)	mm ft in	5,015 16'5.4"	5,015 16'5.4"
F1 Overall height with bucket at full lift (bucket open)	mm ft in	5,591 18'4.11"	5,591 18'4.11"
G Dumping clearance at full lift and 45° tipping angle (bucket), ISO 7131	mm ft in	2,743 9'0.8"	2,811 9'2.7"
G1 Dumping clearance at full lift and 45° tipping angle (blade), ISO 7131	mm ft in	3,253 10'8"	3,253 10'8"
H Reach at full lift and 45° tipping angle (bucket), ISO 7131	mm ft in	1,086 3'6.8"	1,053 3'5.5"
H1 Reach at full lift and 45° tipping angle (blade), ISO 7131	mm ft in	625 2'0.6"	625 2'0.6"
I Width of opening	mm ft in	1,201 3'11.3"	1,201 3'11.3"
Bucket weight	kg/lb	1,820/4,012	1,731/3,816
Operating weight¹⁾	kg/lb	17,239/38,005	17,150/37,809
Ground pressure, ISO 16754¹⁾	kg/cm ² psi	0.62 8.99	0.61 8.85

¹⁾ Incl. coolant and lubricants, full fuel tank, ROPS/FOPS cab, operator, bucket, and track shoes with 508 mm.

²⁾ With 508 mm track shoes. With alternative track shoes on request.

Rear attachments LR 626

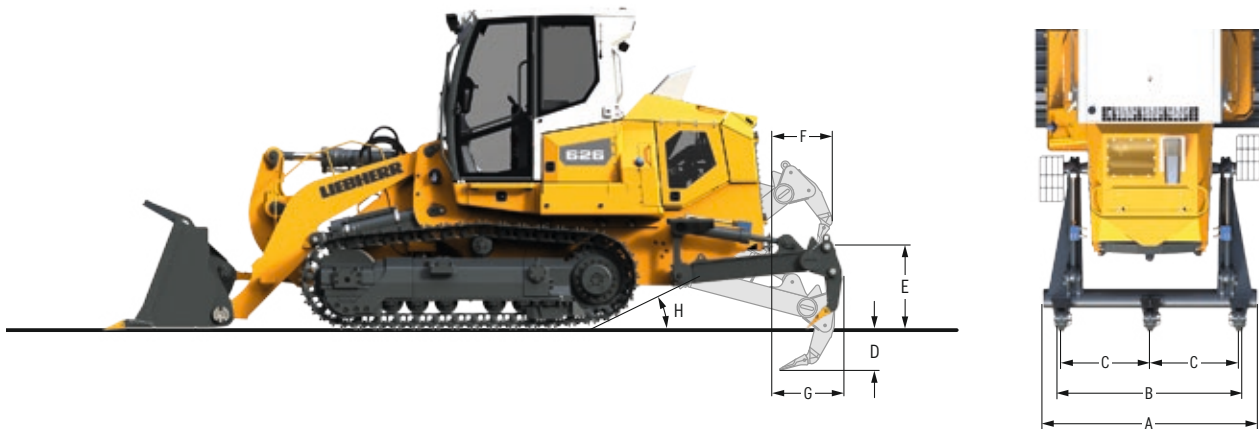

3-Shank ripper radial

A Beam width	mm	2,096
	ft in	6'10.5"
B Ripping width	mm	1,800
	ft in	5'10.9"
C Distance between shanks	mm	870
	ft in	2'10.3"
D Penetration max.	mm	348
	ft in	1'1.7"
E Ground clearance max. below shanks	mm	715
	ft in	2'4.1"
F Reach, rear ripper raised	mm	638
	ft in	2'1.1"
G Reach, rear ripper in transport position	mm	769
	ft in	2'6.3"
H Approach angle, rear ripper raised		21°
	Weight of rear ripper	kg
Change in operating weight	lb	1,911
	kg	830
Change in ground pressure	lb	1,830
	kg/cm ²	0.03
Change in static tipping load	psi	0.42
	kg	1,806 ¹⁾
	lb	3,981 ¹⁾

¹⁾ Change in static tipping load for standard bucket 1.8m³: 1,787 kg; for 4-in-1 bucket: 1,682 kg

Technical data LR 636



Diesel engine

Liebherr Diesel engine	D 934 EVO Emission regulations according to 97/68/EC, 2016/1628/EU Stage V, EPA/CARB Tier 4f
Rated power (net) ISO 9249 SAE J1349	135 kW / 184 HP 135 kW / 181 HP
Maximum power (net) ISO 9249 SAE J1349	160 kW / 218 HP 160 kW / 215 HP
Rated speed	1.800 ¹ /min.
Displacement	7.01 / 427 in ³
Bore / stroke	122 mm (4.80 in) / 150 mm (5.91 in)
Design	4 cylinder in-line engine, water-cooled, turbocharged, air-to-air intercooler
Injection system	Direct fuel injection, Common Rail, electronic control
Lubrication	Pressurized lube system, engine lubrication guaranteed for inclinations up to 45°, on all sides
Operating voltage	24 V
Alternator	140 A
Starter	7.8 kW / 11 HP
Batteries	2 x 180 Ah / 12 V
Air cleaner	Dry-type air cleaner with pre-cleaner and automatic dust ejector, main and safety elements with radial seal
Cooling system	Combination cooler with single cooling units for water, hydraulic oil and intake charge air
Cooling fan	Hydrostatically driven, thermostatically controlled



Hydraulics

Hydraulic system	Load-sensing demand control
Pump type	Variable displacement pump (swash-plate design)
Pump flow max.	234 l/min. / 61.8 gpm / 51.5 Imp.gpm
Pressure limitation	260 bar / 3,770 psi
Filter system	Return filter with magnetic rod in hydraulic tank
Control	Single joystick implement control for all bucket functions, with magnetic detent functions for float position as well as for automatic bucket positioner and for automatic lift kickout
Control block *	Additional hydraulic circuit front and rear for attachments optionally available

* Not available in combination with 4-in-1 bucket or rear ripper



Travel drive, control

Transmission system	Closed-loop infinitely variable hydrostatic travel drive powered by two axial piston variable displacement pumps and two axial piston variable displacement motors in swash-plate design, each track is driven independently from each other
Travel speed*	Sinfinitely variable electronic speed control, V-max via step switch on the encoder adjustable (V1, V2, V3) 2.5- 6.0 km/h (4.0 km/h) / 1.5-3.7 mph (2.5 mph) 2.5- 6.0 km/h (4.5 km/h) / 1.5-3.7 mph (2.8 mph) 4.0- 8.0 km/h (6.0 km/h) / 2.5-5.0 mph (3.7 mph) 4.0- 8.0 km/h (8.0 km/h) / 2.5-5.0 mph (5.0 mph) 6.5-10.0 km/h (10.0 km/h) / 4.0-6.2 mph (6.2 mph) 6.5-10.0 km/h (10.0 km/h) / 4.0-6.2 mph (6.2 mph)
Electronic control	The load limit control monitors electronically the speed of the diesel engine and controls the Diesel engine torque as a function of necessary driving force
Steering	Hydrostatic, unlimited manoeuvrability for full power turns and counterrotation
Service brake	Hydrostatic, dynamic braking effect from travel drive system
Parking/emergency brake	Multi-disc brake, wear-free, automatically applied with neutral joystick position
Cooling system	Hydraulic oil cooler integrated into combination cooler
Filter system	Micro cartridge filters in replenishing circuit
Final drive	Combination spur gear with planetary gear, double sealed (duo cone seals) with electronic seal-integrity indicator
Control	Single joystick for all travel and steering functions, as well as for counterrotation

* Travel speed ranges can be set on the travel joystick



Operator's cab

Cab	Resiliently mounted cab with positive pressure ventilation, can be tilted with hand pump 40° to the rear. With integrated ROPS Rollover Protective Structure (EN ISO 3471) and FOPS Falling Objects Protective Structure (EN ISO 3449).
Heating and air conditioning	Air conditioning meets requirements according to ISO 10263, air is distributed over 12 air vents and 10 blower levels, 6 air routing modes can be set on the control panel
Operator's seat	Air-suspended comfort seat, fully adjustable
Glazing	- Windscreen / Laminated Safety Glass Optional: Polycarbonate - Side window / Tempered Safety Glass Optional: with sliding window (individually selectable on each side) - Rear Window / Tempered Safety Glass Optional: Polycarbonate
Monitoring	Touch screen: display of current machine information, automatic monitoring of operating conditions. Individual setting of machine parameters
Work lights	- LED-Standard (1200 lm each) 4 front side, 2 rear side Optional: 4 front side, 4 rear side - LED-HD (4200 lm each) 4 front side, 2 rear side Optional: 4 front side, 4 rear side
Vibration emission	
Hand / arm vibrations	< 2.5 m/s ² , according with ISO 5349-1:2001
Whole-body vibrations	0.26-1.18 m/s ² , complies with technical report ISO/TR 25398:2006
Measuring inaccuracy	According with standard EN 12096:1997

Undercarriage

Mounting	Pivot shafts and equalizer bar (cushion mounted)
Track chains	Sealed and oil lubricated, chain tension through compression spring and grease clamping cylinder, optional oil-lubricated sleeve chain with FTB available
Links, each side	38
Sprocket segments, each side	5
Track rollers, each side	6
Carrier rollers, each side	1
Track shoes, standard	560 mm / 22", double grouser
Track shoes, optional	508 mm / 20", double grouser, FTB 560 mm / 22", double grouser with trapezoidal hole or FTB 610 mm / 24", double grouser with trapezoidal hole 710 mm / 28", double grouser Wider track shoes available on demand.
Grouser height	42.5 mm / 1.67"

Sound levels

Operator sound exposure ISO 6396 L_{pA} (in the cab)	78 dB(A)
Exterior sound pressure 2000/14/EC L_{WA} (to the environment)	110 dB(A)

Refill capacities

Fuel tank	400 l / 105.7 gal / 88 Imp.gal
Diesel Exhaust Fluid (DEF) tank	45 l / 11.9 gal / 9.9 Imp.gal
Cooling system	38 l / 10 gal / 8.4 Imp.gal
Engine oil, with filter	29 l / 7.7 gal / 6.4 Imp.gal
Hydraulic tank	93 l / 24.6 gal / 20.5 Imp.gal
Pivot shaft, each side	4.5 l / 1.2 gal / 1 Imp.gal
Final drive, each side	20 l / 5.3 gal / 4.4 Imp.gal
Duo cone seal, each side	9.5 l / 2.5 gal / 2.1 Imp.gal

Cycle times

Lifting	5.4 s
Dumping (maximum cylinder stroke)	2.2 s
Dumping (at max. height)	1.5 s
Tilting back (maximum cylinder stroke)	2.9 s
Tilting back (at max. height)	2.0 s
Lowering¹⁾	2.4 s

¹⁾ Float position and empty bucket

Drawbar pull

Max.	280 kN
at 1.5 km/h	277 kN
at 3.0 km/h	138 kN
at 6.0 km/h	69 kN
at 9.0 km/h	46 kN

Dimensions LR 636

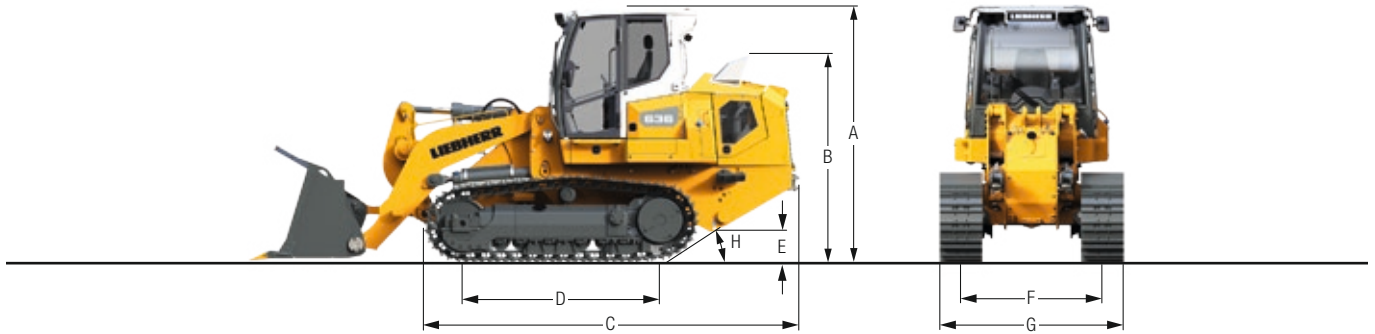

Dimensions

A Height over cab	mm	3,330
	ft in	10'11"
B Height over exhaust pipe	mm	2,715
	ft in	8'11"
C Length to front of track	mm	4,930
	ft in	16'2"
D Distance idler / sprocket center	mm	2,580
	ft in	8'6"
E Ground clearance	mm	483
	ft in	1'7"
F Track gauge	mm	1,830 ¹⁾
	ft in	6'0"
G Track shoes 508 mm / 20"	mm	2,338 ²⁾
	Machine width ft in	7'8"
G Track shoes 560 mm / 22"	mm	2,390 ²⁾
	Machine width ft in	7'10"
G Track shoes 610 mm / 24"	mm	2,440 ²⁾
	Machine width ft in	8'0"
G Track shoes 710 mm / 28"	mm	2,680 ²⁾
	Machine width ft in	8'10"
H Approach angle		30°

¹⁾ Track guard with 610 mm / 24" track shoes: 1,970 mm / 6'6"

²⁾ Minimum bucket width 2,500 mm / 8'2" mm required

Front attachments LR 636

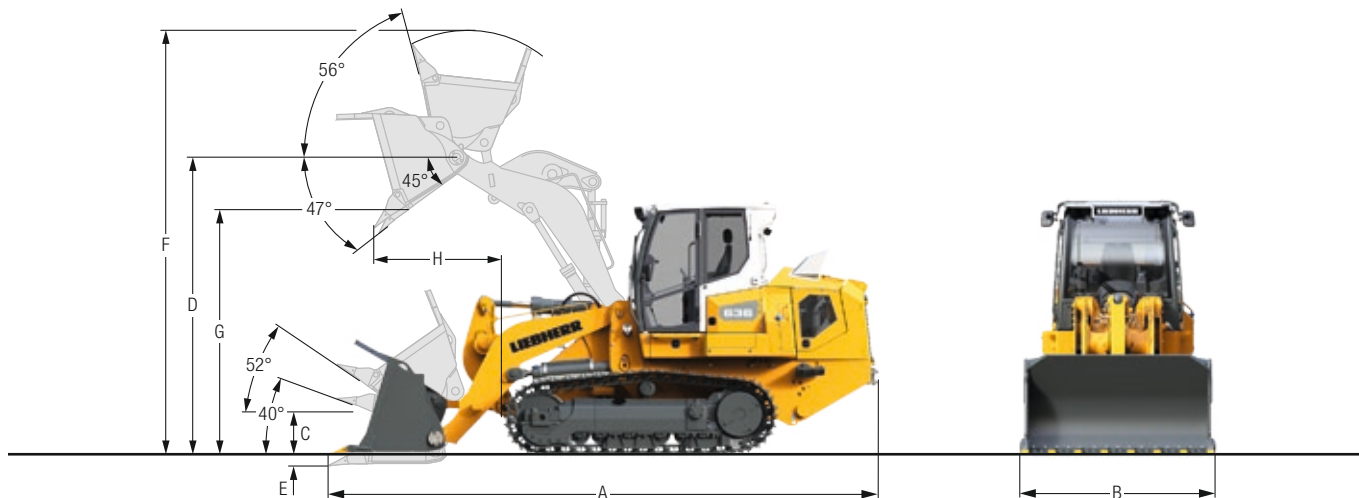

Standard bucket

Version with		Bolt-on adapters, weld-on adapters and shanks	Flush mounted weld-on adapters and shanks	Bolt-on cutting edge
Nominal rated bucket capacity, ISO 7546	m ³	2.4	2.3	2.4
	yd ³	3.14	3.01	3.14
Nominal rated bucket capacity, SAE J742	m ³	2.5	2.3	2.5
	yd ³	3.27	3.01	3.27
Breakout force, ISO 14397	kN	164	180	164
	lb	36,856	40,451	36,856
Static tipping load, ISO 14397	kg	14,950	15,130	15,080
	lb	32,959	33,356	33,246
A Overall length bucket at ground with rear bumper	mm	7,130	7,170	6,960
	ft in	23'5"	23'6"	22'10"
B Bucket width, overall ²⁾	mm	2,571	2,500	2,500
	ft in	8'5"	8'2"	8'2"
C Height of hinge pin, transport position	mm	576	576	576
	ft in	1'11"	1'11"	1'11"
D Height of hinge pin, max.	mm	4,051	4,051	4,051
	ft in	13'3"	13'3"	13'3"
E Digging depth, max.	mm	151	121	151
	ft in	5.94"	4.76"	5.94"
F Overall height with bucket at full lift	mm	5,477	5,477	5,477
	ft in	18'	18'	18'
G Dump clearance at full lift and 45° discharge, ISO 7131	mm	3,059	3,146	3,059
	ft in	10'0"	10'4"	10'0"
H Reach at full lift and 45° discharge, ISO 7131	mm	1,244	1,195	1,244
	ft in	4'1"	3'11"	4'1"
Bucket weight	kg	1,720	1,539	1,589
	lb	3,792	3,393	3,503
Operating weight ¹⁾	kg	21,870	21,690	21,740
	lb	48,215	47,818	47,928
Ground pressure ¹⁾	kg/cm ²	0.66	0.66	0.66
	psi	9.44	9.36	9.39

¹⁾ Including coolant and lubricants, full fuel tank, ROPS / FOPS cab, operator, bucket, counterweight(s) and track shoes with 560 mm / 22".

²⁾ Track shoes with 560 mm / 22". With other track shoes on demand at your dealer.

Front attachments LR 636

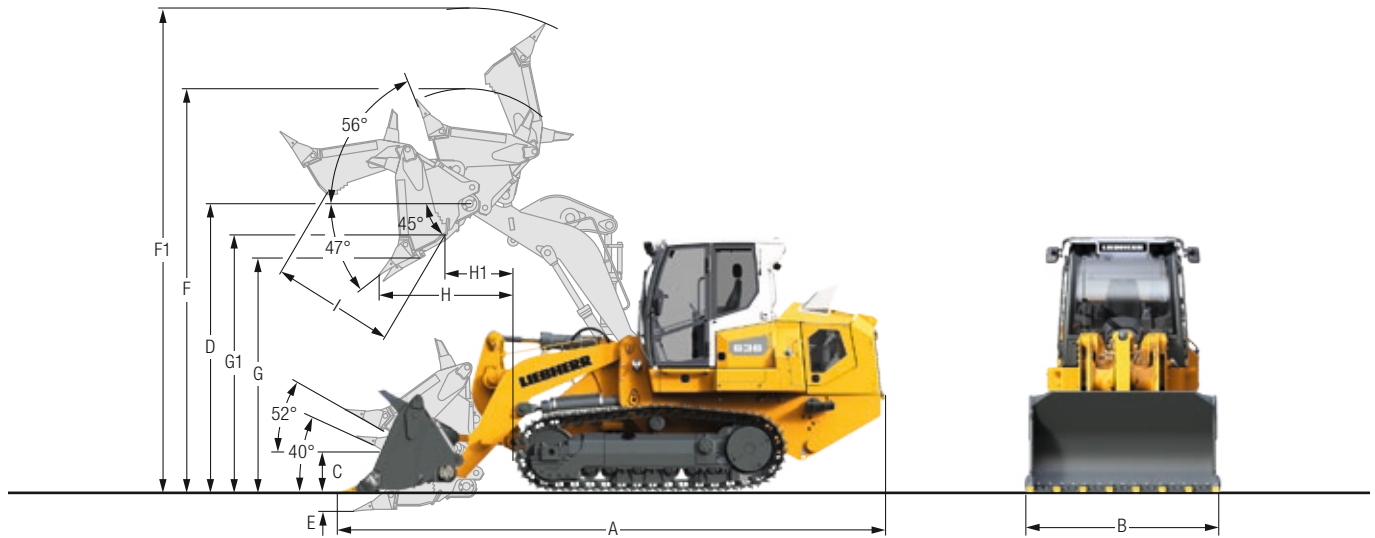

Multi-purpose bucket

Version with		Bolt-on adapters, weld-on adapters and shanks	Flush mounted weld-on adapters and shanks	Bolt-on cutting edge
Nominal rated bucket capacity, ISO 7546	m ³ / yd ³	2.0/2.62	1.9/2.49	2.0/2.62
Nominal rated bucket capacity, SAE J742	m ³ / yd ³	2.1/2.75	1.9/2.49	2.1/2.75
Breakout force, ISO 14397	kN / lb	155 / 34,845	169 / 37,992	155 / 34,845
Static tipping load, ISO 14397	kg / lb	13,025 / 28,715	13,775 / 30,369	13,150 / 28,991
A Overall length bucket at ground with rear bumper	mm ft in	7,094 23'3"	6,978 22'11"	7,094 23'3"
B Bucket width, overall ²⁾	mm ft in	2,529 8'4"	2,500 8'2"	2,490 8'2"
C Height of hinge pin, transport position	mm ft in	576 1'11"	576 1'11"	576 1'11"
D Height of hinge pin, max.	mm ft in	4,051 13'3"	4,051 13'3"	4,051 13'3"
E Digging depth, max.	mm ft in	220 8.66"	190 7.48"	220 8.66"
F Overall height with bucket at full lift (bucket closed)	mm ft in	5,458 17'11"	5,458 17'11"	5,458 17'11"
F1 Overall height with bucket at full lift (bucket open)	mm ft in	6,160 20'3"	6,070 19'11"	6,160 20'3"
G Dump clearance at full lift and 45° discharge (bucket), ISO 7131	mm ft in	2,966 9'9"	3,053 10'0"	2,966 9'9"
G1 Dump clearance at full lift and 45° discharge (blade), ISO 7131	mm ft in	3,576 12'9"	3,576 11'9"	3,576 11'9"
H Reach at full lift and 45° discharge (bucket), ISO 7131	mm ft in	1,238 4'1"	1,189 3'11"	1,238 4'1"
H1 Reach at full lift and 45° discharge (blade), ISO 7131	mm ft in	691 2'3"	691 2'3"	691 2'3"
I Width of opening	mm / ft in	1,290 / 4'3"	1,290 / 4'3"	1,290 / 4'3"
Bucket weight	kg / lb	2,281 / 5,029	2,115 / 4,663	2,161 / 4,764
Operating weight ¹⁾	kg / lb	22,541 / 49,694	22,424 / 49,436	22,410 / 49,406
Ground pressure ¹⁾	kg/cm ² / psi	0.69 / 9.84	0.69 / 9.80	0.68 / 9.79

¹⁾ Including coolant and lubricants, full fuel tank, ROPS/FOPS cab, operator, bucket, counterweight and track shoes with 508 mm / 20".

²⁾ Track shoes with 508 mm / 20". With other track shoes on demand at your dealer.

Rear attachments LR 636





3-Shank ripper radial

In combination with		Standard bucket up to 3.01yd ³	Standard bucket greater than 3.01yd ³	Multi-purpose bucket (all sizes)
A Beam width	mm	2,100	2,100	2,100
	ft in	6'11"	6'11"	6'11"
B Ripping width	mm	1,860	1,860	1,860
	ft in	6'1"	6'1"	6'1"
C Distance between shanks	mm	900	900	900
	ft in	2'11"	2'11"	2'11"
D Penetration max.	mm	365	365	365
	ft in	1'2"	1'2"	1'2"
E Ground clearance, max. below shanks	mm	883	883	883
	ft in	2'11"	2'11"	2'11"
F Additional length, ripper raised	mm	604	604	604
	ft in	2'	2'	2'
G Additional length, transport position	mm	715	715	715
	ft in	2'4"	2'4"	2'4"
H Approach angle, ripper raised		21°	21°	21°
Ripper weight ¹⁾	kg	1,106	1,106	1,106
	lb	2,438	2,438	2,438
Change in operating weight	kg	853	506	506
	lb	1,881	1,116	1,116
Change in ground pressure	kg/cm ²	0.03	0.02	0.02
	psi	0.37	0.21	0.21
Change in static tipping load	kg	1,897	1,285	1,762
	lb	4,182	2,833	3,885

¹⁾ If the ripper is mounted, no counterweight will be fitted to the machine.

Equipment

	LR 626	LR 636
 Base machine		
Equipment operating temperature - 30 °C to + 55 °C	+	+
Waste handling equipment	+	+
Auto idle	+	+
Tank guard	+	+
Refuelling pump	+	+
Vehicle tool kit, basic	●	●
Vehicle tool kit, extended	+	+
Corrosion protection package	+	+
Fuel filter with water separator	●	●
Heated fuel filter with water separator	+	+
Radiator coarse mesh	●	●
Reinforced radiator guard, hinged	●	●
LiDAT - data transmission system	●	●
Liebherr Diesel engine emission stage IV / tier 4 final	●	●
Cooling fan, reversible	+	+
Cooling fan, hinged	●	●
Cooling fan, hydraulically driven	●	●
Air pre-filter	+	+
Automatic engine cut-off	+	+
Engine compartment doors, lockable	●	●
Lugs for crane lift, front and rear	+	●
Customised paint finish, single and multiple colours	+	+
Spade holder	+	+
Rear step, right	+	+
Air filter, dry type with pre-filter and automatic dust ejector	●	●
Lashing eyes front and rear	●	●
Central lubrication system	+	+
Towing hitch, rear	●	●

	LR 626	LR 636
 Hydraulics system		
Demand control, flow rate distribution	●	●
Electronic pilot controls for operating hydraulics	●	●
Return filter (in tank)	●	●
Bucket quick drop function	●	●
Bucket float function	●	●
Additional operating circuit, front and rear	+	+

	LR 626	LR 636
 Travel drive		
3-range speed control	●	●
Automatic parking brake	●	●
Electronic load limit control	●	●
Proportional drive hydraulic joystick	●	●
V-pattern drive hydraulic control with steering pedals	+	+
Hydrostatic drive	●	●
Inch brake pedal	+	+
Machine-release switch	●	●
Emergency stop switch	●	●
Planetary gear final drive	●	●
Seat contact switch	●	●

	LR 626	LR 636
 Operator's cab		
Armrests connected to driver's seat	●	●
Access and exit step lighting	+	+
9 inch colour touch display	●	●
Pressure ventilation	●	●
Comfort driver's seat, air-cushioned	●	●
Premium driver's seat, air-cushioned	+	+
Fire extinguisher, 6 kg	+	+
Radio key with central locking	+	+
Sound proof cabin mounts	●	●
Interior lighting	●	●
Cabin tilttable 40°	●	●
Automatic AC with heating	●	●
Radio key for cabin door	●	●
Polycarbonate windscreen	+	+
Polycarbonate rear window	+	+
Radio pre-installation	+	+
Comfort Radio with Bluetooth	+	+
Standard Radio without Bluetooth	+	+
Integrated ROPS / FOPS	●	●
Reversing camera	●	●
Rear view interior mirror	●	●
Windscreen wash/wipe system	●	●
Windscreen wipers front and rear, with intermittent setting	●	●
Sliding window, left	+	+
Sliding window, right	+	+
Guard grille for windscreen	+	+
Guard grille for rear window	+	+
Side mirrors, left and right	+	+
3-Point safety belt	+	+
safety belt, 3-inches wide	+	+
4-Point safety belt	+	+
Tinted safety glass	●	●
Sun visor, front	●	●
12 V socket outlet	●	●
24 V socket outlet	●	●
External cabin sun visor	+	+

● = Standard
+ = Option

Equipment

 Electrical system	LR 626	LR 636
	LED units for all work lights	●
Work lights on cabin, 4 units front, 2 units rear, each 1,200 lm	●	●
Work lights on cabin, 4 units front, 2 units rear, each 4,200 lm	+	+
Work lights on cabin, 4 units front, 4 units rear, each 1,200 lm	+	+
Work lights on cabin, 4 units front, 4 units rear, each 4,200 lm	+	+
Main battery switch	●	●
On-board voltage 24 V	●	●
Engine compartment lighting	●	●
Reverse warning device acoustic and visual with broadband signal	+	+
Amber beacon	+	+
Guard grille for front work lights on cabin	+	+
Horn	●	●
Electronic immobiliser	+	+

 Undercarriage	LR 626	LR 636
	Track shoes with mud holes	+
Track shoes, moderate service	●	●
Undercarriage with rotary bushings FTB	+	+
Track frame, closed	●	●
Bolt-on sprocket segments	●	●
Two-piece master chain link	●	●
Centre track guide	+	+
Track guide front and rear	●	●
Tracks, oil lubricated	●	●
Track guard full length	+	+
Guide wheel deflector	●	●
Custom track width	+	+
Protection ring, final drive	-	+
Sprocket deflector	●	●
Door Segments with Recesses	●	●

 Rear attachments	LR 626	LR 636
	Rear scraper bar	+
Draw bar, rigid - SAE J749	+	+
Rear counterweight with towing hitch	-	●
3-shank rear ripper	+	+

 Front attachments	LR 626	LR 636
	4in1 bucket - 1.5 and 1.6 m ³	+
4in1 Bucket - 1.9 and 2.0 m ³	-	+
Bolt-on teeth adapters	+	+
Weld-on teeth adapters	+	+
Trash rack for 4in1 bucket	+	+
Trash rack for standard bucket	+	+
Refuse bucket - 4.6 m ³	-	+
Guard for lift cylinder	+	●
Guard for tilt cylinder	+	+
Guard for clamping cylinder, 4in1 bucket	+	+
Standard bucket - 1.7 and 1.8 m ³	+	-
Standard Bucket - 2.3 and 2.4 m ³	-	+
Standard Bucket - 2.8 m ³	-	+
Overrun plate for standard bucket	+	+
Reversible bolt-on cutting edge	+	+
Reversible bolt-on cutting segment	+	+
Z-kinematics	●	●

 Technology	LR 626	LR 636
	Automatic rear ripper lift	+
CAN data interface J1939	+	+
End position damping	●	●
Automatic lift and lower shut-off	●	●
Undercarriage wear indication	+	+
Automatic dump and return function	●	●
Bucket shake function	●	●

● = Standard
+ = Option

Equipment and special attachments from third-party suppliers may only be installed with the explicit permission of Liebherr.

The Liebherr Group



Global and independent: more than 70 years of success

Liebherr was founded in 1949. With the development of the world's first mobile tower crane, Hans Liebherr laid the foundations of a successful family business which today comprises more than 140 companies on all continent and employs nearly 51,000 people. The parent company of the Group is Liebherr-International AG in Bulle (Switzerland), whose associates are exclusively members of the Liebherr family.

Technology leadership and pioneering spirit

Liebherr regards itself as a pioneer. This spirit has enabled the company to make a decisive contribution to the technological history of many industries. Today, employees around the world still share the courage of the company founder to take new paths. They are all united by a passion for technology and fascinating products and the determination to perform outstanding work for their customers.

Widely diversified product portfolio

Not only is Liebherr one of the biggest construction equipment manufacturers in the world, it also provides high-quality, user-oriented products and services in a wide range of other areas. The product portfolio includes the segments earthmoving, material handling technology, deep foundation machines, mining, mobile and crawler cranes, tower cranes, concrete technology, maritime cranes, aerospace and transportation systems, gear technology and automation systems, refrigeration and freezing, components and hotels.

Customized solutions and maximum customer benefit

Liebherr solutions are characterized by maximum precision, outstanding implementation and exceptional longevity. Its mastery of key technologies enables the company to offer its customers customized solutions. For Liebherr, customer focus does not end with the product; it also encompasses a wide range of services that make a real difference.

www.liebherr.us

WARNING

Breathing diesel engine exhaust exposes you to chemicals known to the State of California to cause cancer and birth defects or other reproductive harm.

- Always start and operate the engine in a well-ventilated area.
- If in an enclosed area, vent the exhaust to the outside.
- Do not modify or tamper with exhaust system.
- Do not idle the engine except as necessary.

For more information go to www.P65warnings.ca.gov/diesel.

WARNING

This product can expose you to chemicals including lead and lead compounds, which are known to the State of California to cause cancer and birth defects or other reproductive harm.

For more information go to www.P65warnings.ca.gov.

Liebherr-Werk Telfs GmbH

Hans-Liebherr-Straße 35 • 6410 Telfs, Austria • Phone +43 50809 6-100 • Fax +43 50809 6-7772
lwt.marketing@liebherr.com • www.liebherr.com • www.facebook.com/LiebherrConstruction