

Crawler Crane

LR 1130
Litronic®

EN

LR 1002.03



LIEBHERR

Dimensions

Basic machine with undercarriage

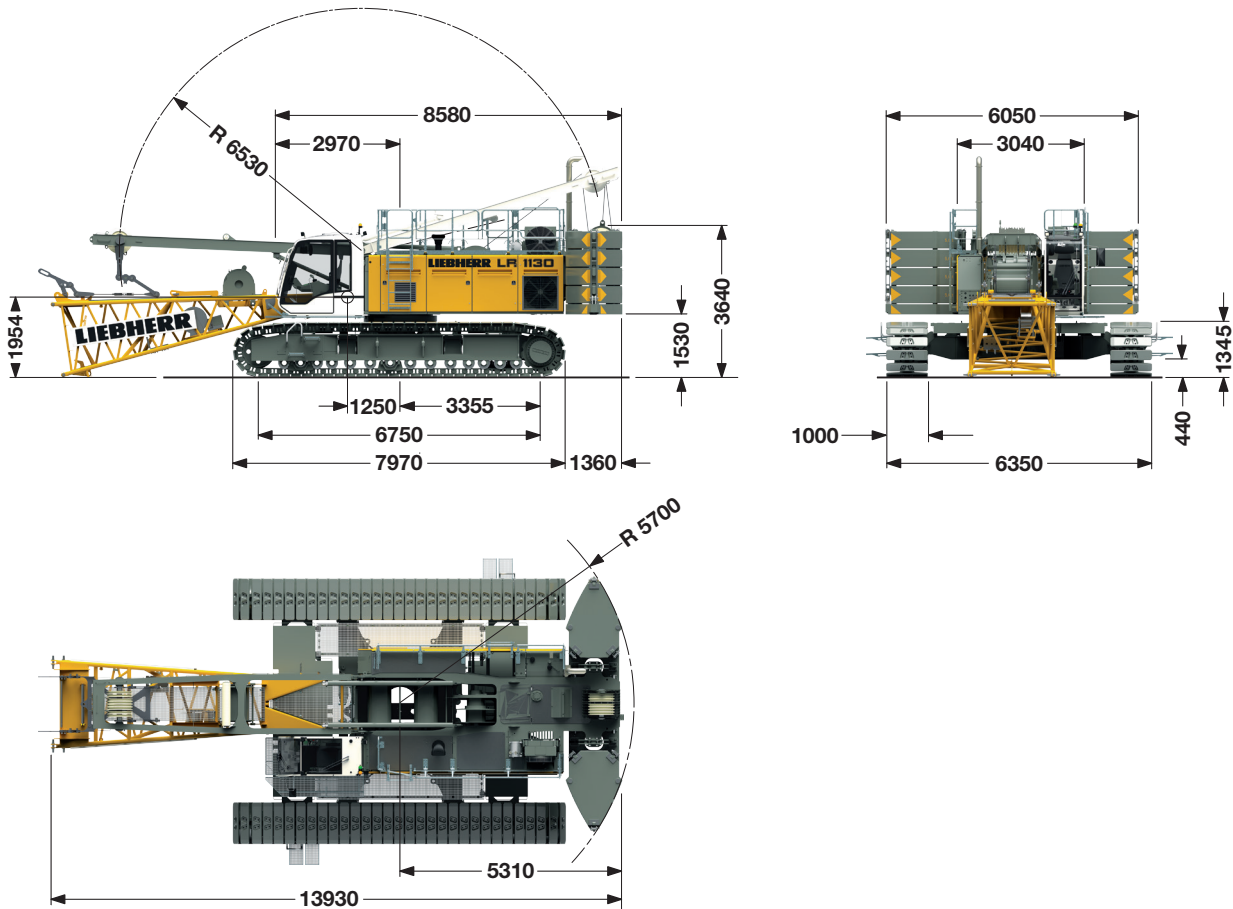

Operating weight

The operating weight includes the basic machine with crawlers, 2 main winches 120 kN and 17 m main boom, consisting of A-frame, boom foot (7 m), boom head (10 m), 52.3 t basic counterweight, 20 t carbody-counterweight and 160 t hook block.

Total weight _____ approx. 146.1 t

Ground pressure

The actual ground pressure is calculated according to the configuration and position of the machine and displayed in the operator's cab. Using the optional Liebherr Crane-Planner the actual ground pressure, amongst other parameters, can already be calculated and displayed in the planning stage.

Equipment

Main boom (No. 2017.xx) max. length	_____	80.0 m
High reach (No. 2017.xx and 1309.xx)	_____	92.9 m
Luffing jib (No. 1309.xx) max. length	_____	78.5 m
Max. combination	_____ main boom	47.0 m
	_____ luffing jib	78.5 m
Fixed jib (No. 0806.xx)	_____	11 – 32 m
Auxiliary jib 24 t (option 36 t)		

Remarks

1. The lifting capacities stated are valid for lifting operation only (corresponding with crane classification according to F.E.M. 1.001, crane group A1).
2. Crane standing on firm, horizontal ground.
3. The weight of the lifting device (hoist ropes, hook block, shackle etc.) must be deducted from the gross lifting capacity to obtain a net lifting value.
4. Additional equipment on boom (e.g. boom walkways, auxiliary jib) must be deducted to get the net lifting capacity.
5. For max. wind speed please refer to lift chart in operator's cab or manual.
6. Working radii are measured from centre of swing and under load.
7. The lifting capacities are valid for 360 degrees of swing.
8. Calculation of stability under load is based on DIN 15019 / part 2 / chart 1 and ISO 4305 Table 1 + 2, tipping angle 4°.
9. The structures are calculated according to F.E.M. 1.001 - 1998 (EN 13001-1; EN 13001-2).

Transport dimensions and weights

Basic machine and main boom (No. 2017.xx)

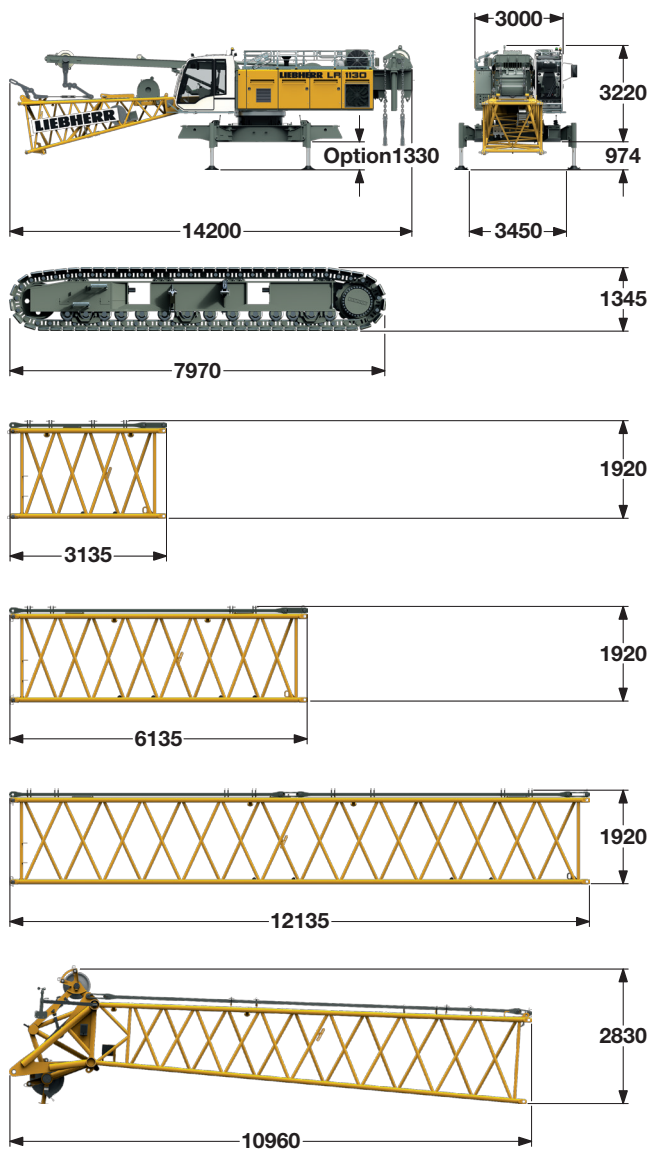

Basic machine

with A-frame, 2x 120 kN crane winches without boom foot, hoist ropes, basic counterweight and crawlers

Width	3000 mm
Weight	33400 kg
Weight of hoist rope (420 m)	3.428 kg/m

Crawler

2x

Track pads	(option 1200) 1000 mm
Width	1400 mm
Weight	16000 kg

Boom section (No. 2017.21)

3 m

Width	2100 mm
Weight* incl. main boom pendants	570 kg
Weight* incl. main boom and luffing jib pendants	640 kg

Boom section (No. 2017.21)

6 m

Width	2100 mm
Weight* incl. main boom pendants	930 kg
Weight* incl. main boom and luffing jib pendants	1016 kg

Boom section (No. 2017.21)

12 m

Width	2100 mm
Weight* incl. main boom pendants	1655 kg
Weight* incl. main boom and luffing jib pendants	1870 kg

Boom head (No. 2017.21)

Width	2100 mm
Weight* incl. main boom pendants	3000 kg

Transport option

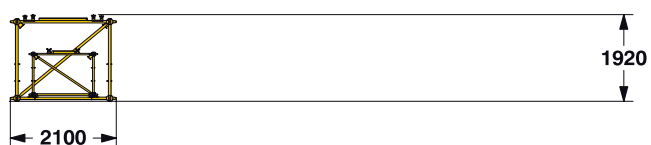

Boom transport option

(No. 2017.xx/1309.xx)	6/6	12/11.7	m
Length	6130	12130	mm
Weight*	1580	2830	kg

*) Weights depend on the equipment installed

Transport dimensions and weights

Luffing jib (No. 1309.xx)

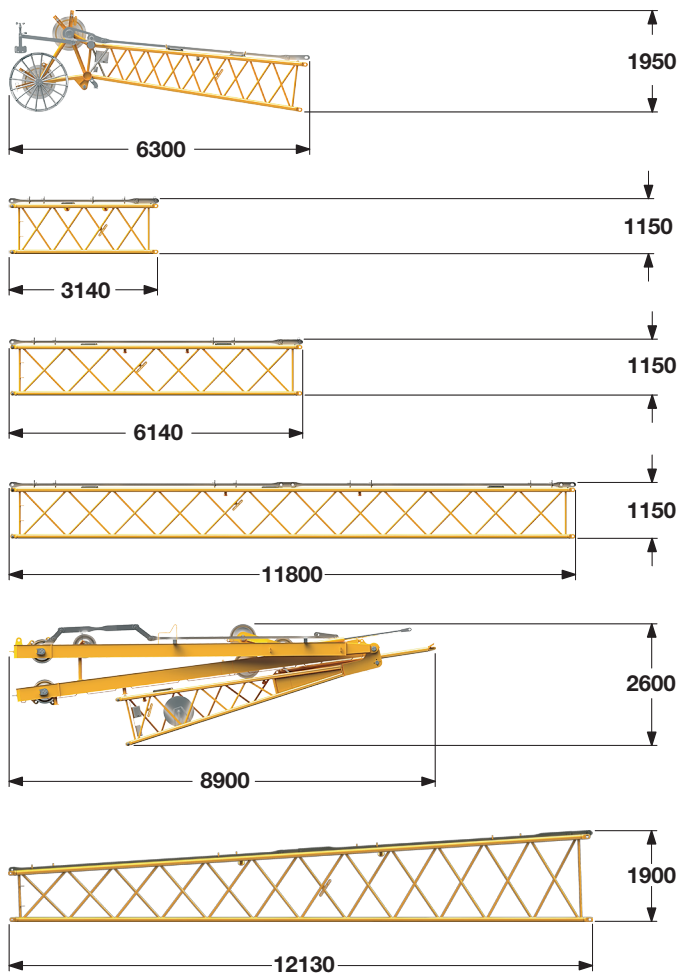

Luffing jib head (No. 1309.22)

Width	1390 mm
Weight*	1125 kg

Luffing jib section (No. 1309.20)

3 m

Width	1390 mm
Weight*	305 kg

Luffing jib section (No. 1309.20)

6 m

Width	1390 mm
Weight*	510 kg

Luffing jib section (No. 1309.20)

11.7 m

Width	1390 mm
Weight*	945 kg

Luffing jib foot with A-frames (No. 1309.22)

Width	1700 mm
Weight*	4525 kg

L-boom section tapered (No. 2017/1309.20)

12 m

Width	2100 mm
Weight*	1060 kg

*) Including pendants

Fixed jib (No. 0806.xx)

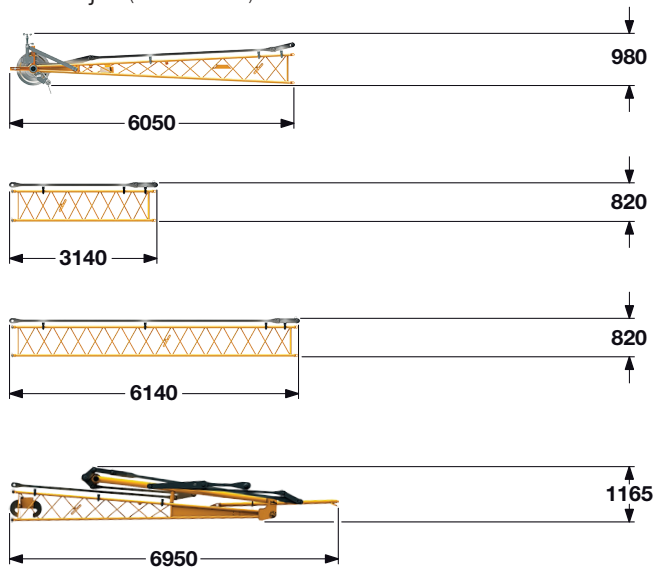

Fixed jib head (No. 0806.16)

Width	950 mm
Weight*	445 kg

Fixed jib section (No. 0806.15)

3 m

Width	950 mm
Weight*	145 kg

Fixed jib section (No. 0806.15)

6 m

Width	950 mm
Weight*	250 kg

Fixed jib foot with A-frame (No. 0806.16)

Width	2200 mm
Weight*	1115 kg

*) Including pendants

Transport dimensions and weights

Counterweights

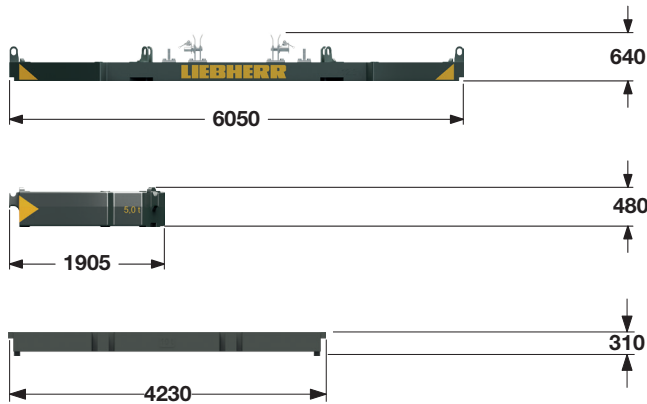

Counterweight		1x
Width	1360 mm	
Weight	12000 kg	

Counterweight		8x
Width	1350 mm	
Weight	5000 kg	

Carbody counterweight		2x
Width	1435 mm	
Weight	10000 kg	

Mid fall (option)

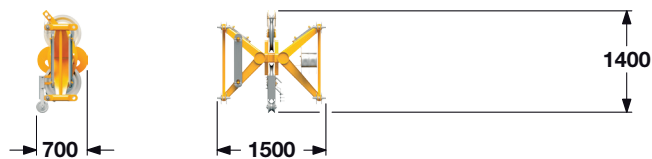

Mid fall section (No. 1309.32)		0.35 m
Width	700 mm	
Weight	270 kg	

Hooks

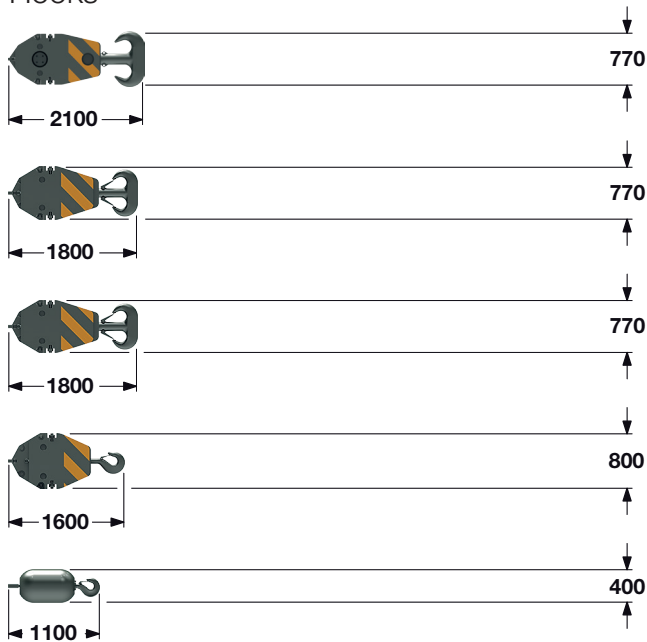

160 t hook block – 7 sheaves			
Width	640	760	880 mm
Weight	1500	2250	3000 kg

100 t hook block – 5 sheaves			
Width	540	670	770 mm
Weight	1300	1800	2300 kg

80 t hook block – 3 sheaves			
Width	360	460	560 mm
Weight	1000	1500	2000 kg

40 t hook block – 1 sheave			
Width	300	400	500 mm
Weight	700	1100	1500 kg

12.5 t single hook	
Width	400 mm
Weight	600 kg

Boom combinations

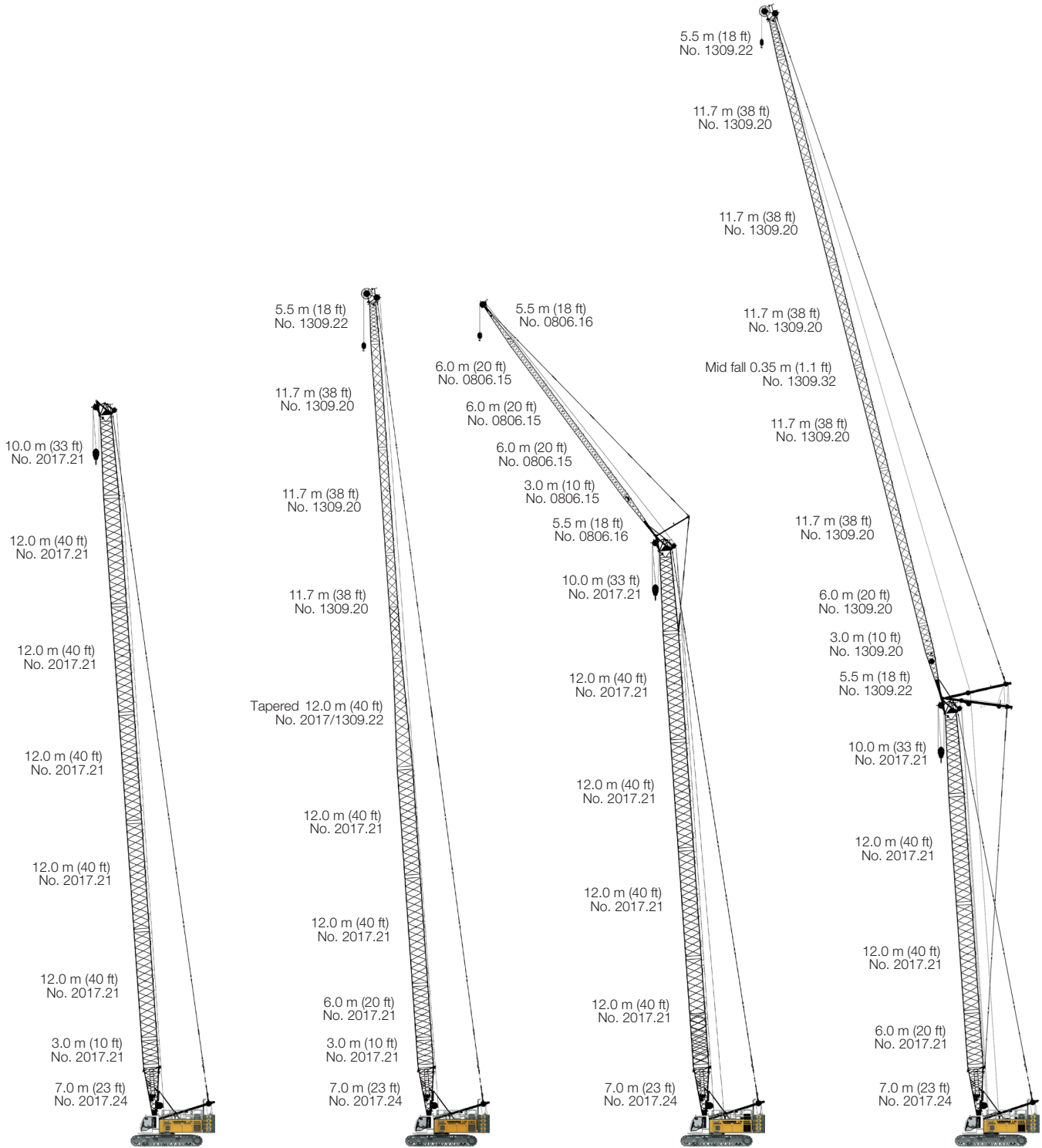

Main boom No. 2017.xx — 80 m

Max. combination	- 92.6 m	92.9 m
Main boom		
No. 2017.xx	40.0 m	52.0 m
Tapered		
No. 2017/1309.xx	12.0 m	12.0 m
Luffing jib		
No. 1309.xx	40.6 m	28.9 m

Max. combination	— 97 m
Main boom No. 2017.xx	65 m
Fixed jib	
No. 0806.xx	32 m
Main boom No. 2017.xx	68 m
Fixed jib	
No. 0806.xx	29 m

Max. combination	— 125.5 m
Main boom No. 2017.xx	47.0 m
Luffing jib	
No. 1309.xx	78.5 m
Main boom No. 2017.xx	53.0 m
Luffing jib	
No. 1309.xx	49.1 m

Technical description



Engine

Power rating according to ISO 9249, 230 kW (308 hp) at 1700 rpm
Engine type ———— Liebherr D 944 A7-04
Fuel tank ———— 790 l capacity with continuous level indicator and reserve warning
Engine complies with NRMM exhaust certification EPA/CARB Tier 4f and 97/68 EC Stage IV.



Hydraulic system

A double axial displacement pump supplies the open loop hydraulic system, allowing all functions to be operated simultaneously. To minimize peak pressure an automatic working pressure cut-off is integrated in the pump. All filters are electronically monitored. The use of synthetic environmentally friendly (biodegradable) oils is possible.
Working pressure ———— max. 350 bar
Oil tank capacity ———— 650 l



Luffing jib winch

Line pull ———— max. 105 kN
Rope diameter ———— 20 mm
Jib luffing ———— 46 sec. from 15° to 78°



Boom winch

Line pull ———— max. 217 kN
Rope diameter ———— 24 mm
Boom up ———— 96 sec. from 15° to 86°



Crawlers

Propulsion through axial piston motor, hydraulically released spring loaded multi-disc brake, crawler tracks, hydraulic chain tensioning device.
Track pads ———— 1000 mm (Option: 1200 mm)
Drive speed ———— 0 – 2.1 km/h



Swing

Consists of rollerbearing with external teeth, swing drive with fixed axial piston hydraulic motor, spring loaded and hydraulically released multi-disc holding brake, planetary gearbox and pinion.
Both swing modes are possible – speed control or free swing.
A multi-disc holding brake acts automatically at zero swing motion. Swing speed from 0 – 3 rpm continuously variable.



Main winches

Line pull (7th layer) ———— 120 kN
Rope diameter ———— 26 mm
Drum diameter ———— 580 mm
Rope speed ———— 0 – 136 m/min
Rope capacity in 7 layers ———— 489 m
The winches are outstanding in their compact design and easy assembly. Propulsion is via a planetary gearbox in an oil bath.
Load support by the hydraulic system; additional safety factor provided by a spring loaded, multi-disc holding brake. The main winches use pressure controlled, variable flow hydraulic motors. This system features sensors that automatically adjust oil flow to provide max. winch speed depending on load.

Option – winch with free-fall system:
Clutch and braking functions on the free-fall system are provided by a compact designed, low wear and maintenance-free multi-disc brake.



Control

The heart of the hydraulic crawler cranes is the Liebherr control system which has been developed and manufactured in-house. It includes all control and monitoring functions and is designed to withstand extreme environmental conditions and heavy duty construction tasks. Complete machine operating data as well as warning signals and irregularities are clearly displayed on the high resolution monitor in the operator's cab in the required language.
The electro-hydraulic proportional control allows several movements to be performed simultaneously. This ensures that all categories of loads can be positioned with utmost precision.

Option:
GSM/GPRS telematics module



Noise emission

Noise emissions correspond with 2000/14/EC directive.
Guaranteed sound pressure level L_{PA} in the cabin ———— ≤ 72.5 dB(A)
Guaranteed sound power level L_{WA} ———— ≤ 105 dB(A)
Vibration transmitted to the hand-arm system of the machine operator ———— < 2.5 m/s²
Vibration transmitted to the whole body of the machine operator ———— < 0.5 m/s²

Self assembly system

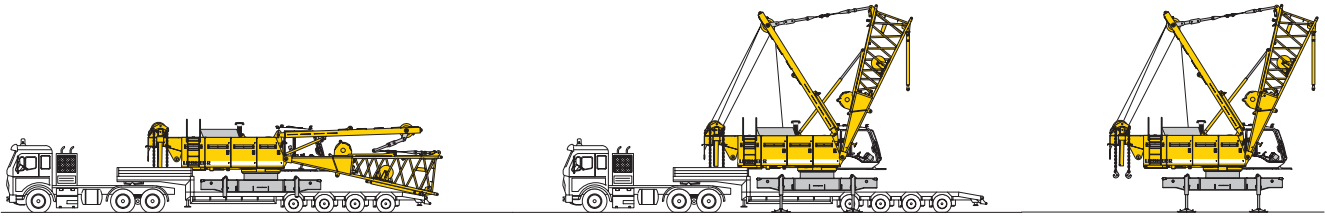

Unloading of basic machine

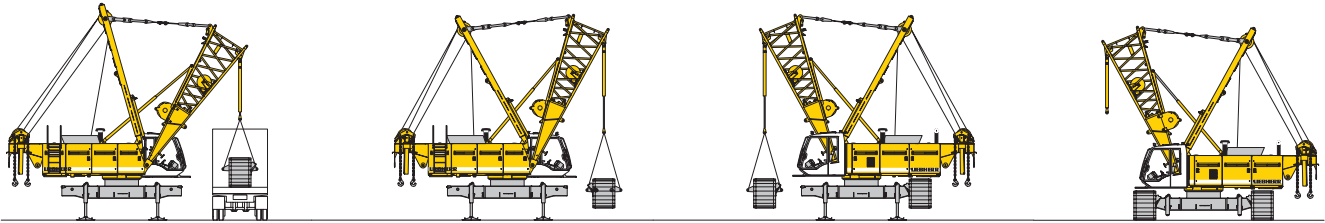

Unloading and assembly of crawlers

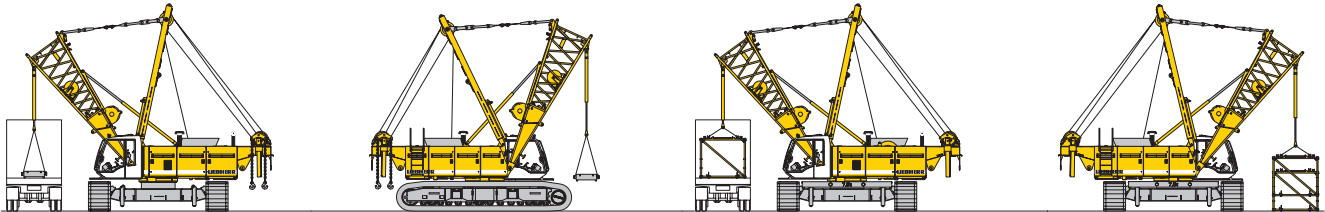

Unloading and assembly of carbody counterweight

Unloading and assembly of boom

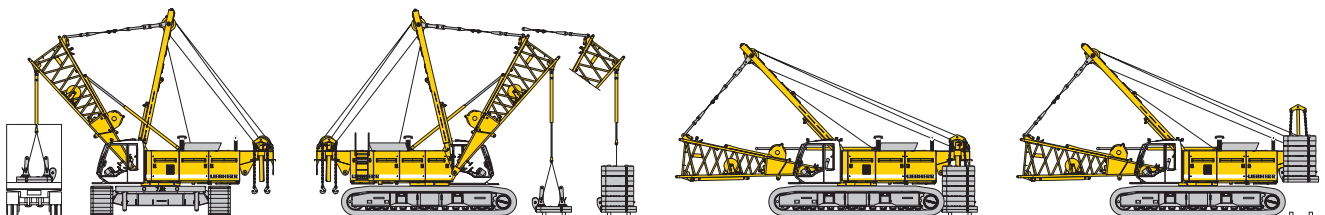

Unloading and assembly of counterweight

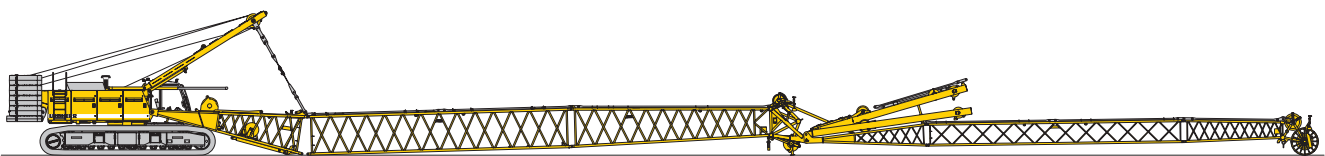

Assembly of boom

Erecting of main boom to working position

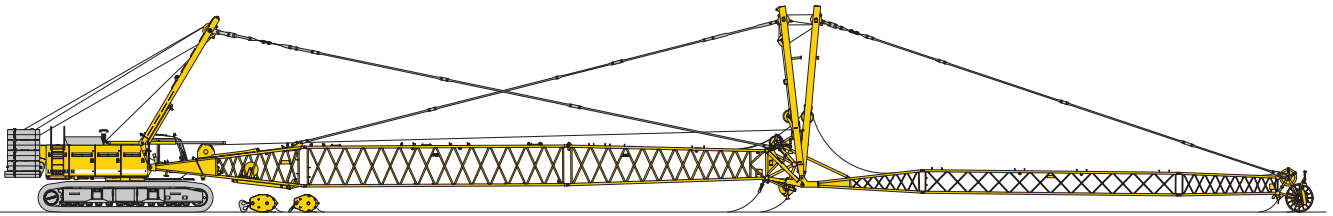

Reeving of hoist and luffing jib ropes



Erecting of main boom and luffing jib

Working position

Main boom 86° - 15° (No. 2017.xx)

52.3 t counterweight and 20 t carbody counterweight

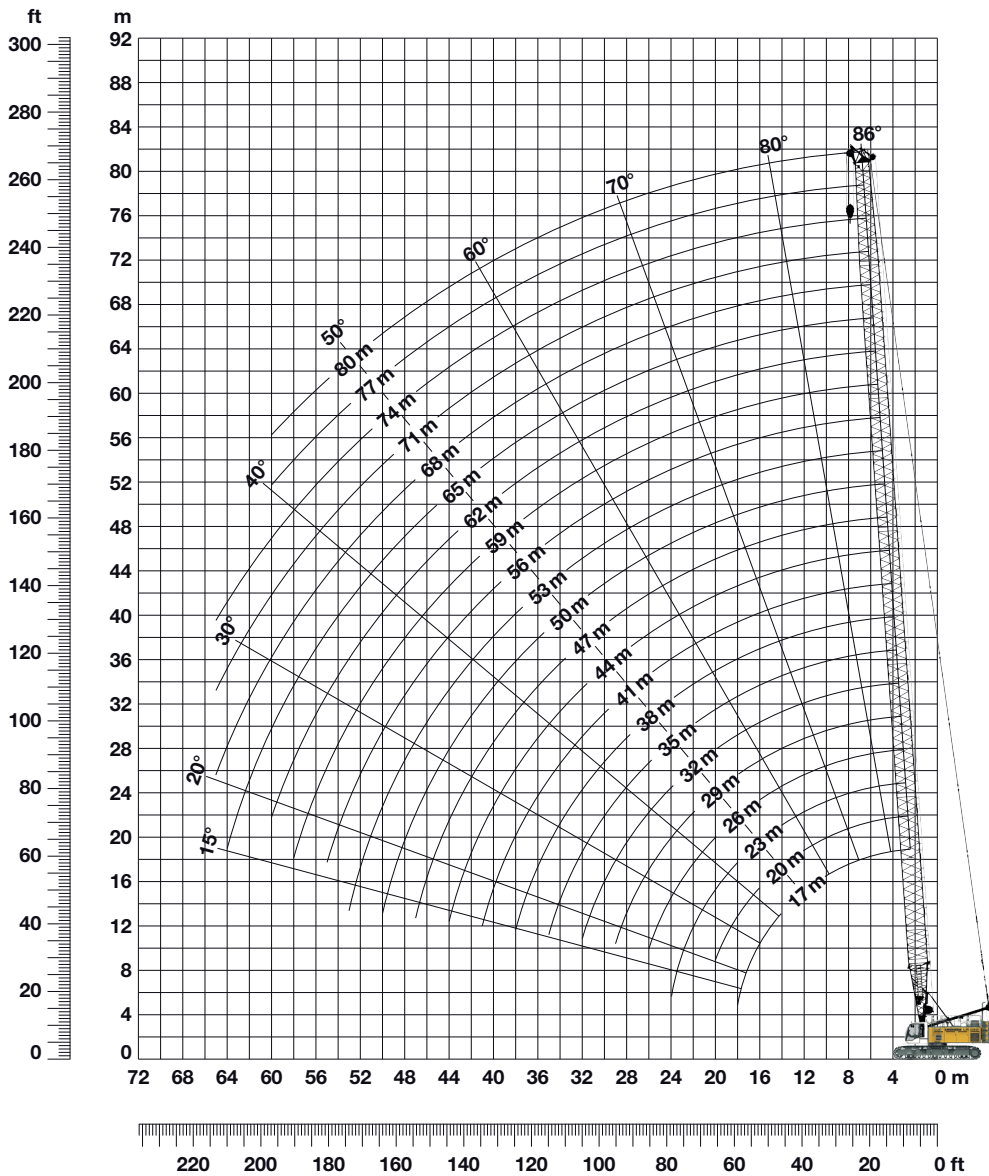

Auxiliary jib 24 t

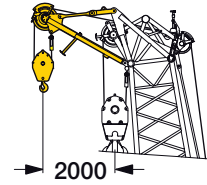

The maximum capacity of the auxiliary jib is 24 t. The corresponding load chart is programmed in the LMI system.

Main boom configuration (Table 1 – No. 2017.xx) Configuration for boom lengths between 17 m and 80 m

	Length	Amount of boom extensions																					
Boom foot	7 m	1	1	1	1	1	1	1	1	1	1	1	1	1	1	1	1	1	1	1	1	1	
Boom insert	3 m		1		1		1		1		1		1		1		1		1		1		
Boom insert	6 m			1	1		1	1		1		1		1		1		1		1		1	
Boom insert	12 m					1	1	1	1		2	2	2	2		3	3	3	3		4	4	
Boom head	10 m	1	1	1	1	1	1	1	1	1	1	1	1	1	1	1	1	1	1	1	1	1	
Boom length (m)		17	20	23	26	29	32	35	38	41	44	47	50	53	56	59	62	65	68	71	74	77	80
Auxiliary jib applicable		✓	✓	✓	✓	✓	✓	✓	✓	✓	✓	✓	✓	✓	✓	✓	✓	✓	✓	✓	✓	✓	✓

Lift chart for main boom (No. 2017.xx)

Counterweight 42.3 t 52.3 t and 20 t carbody counterweight

Capacities in metric tonnes for boom lengths (17 m - 80 m) with 120 kN winches

Radius (m)	Boom length in (m)																								Radius (m)		
	17		20		26		32		38		44		50		56		62		68		71		77			80	
	t	t	t	t	t	t	t	t	t	t	t	t	t	t	t	t	t	t	t	t	t	t	t	t		t	t
3.4	137.2	137.2																								3.4	
4	137.2	137.2	133.4	133.4																						4	
5	116.5	116.5	114.2	114.2	107.7	107.7	97.3	97.3	79.9	79.9																5	
6	98.6	98.6	97.4	97.4	92.5	92.5	88.0	88.0	75.0	75.0	62.0	62.0	52.7	52.7												6	
7	85.7	85.7	83.6	83.6	81.2	81.2	76.5	76.5	69.2	69.2	56.9	56.9	50.3	50.3	44.9	44.9	36.7	36.7	29.1	29.1						7	
8	75.0	75.0	74.2	74.2	71.2	71.2	67.7	68.4	62.5	62.5	53.0	53.0	47.5	47.5	42.9	42.9	35.6	35.6	28.9	28.9	26.5	26.5	21.8	18.9		8	
9	66.8	66.8	66.0	66.0	62.9	63.6	59.4	61.3	56.1	57.6	49.1	49.1	44.7	44.7	41.5	41.5	34.3	34.3	27.7	27.7	25.5	25.5	21.4	18.8		9	
10	58.0	60.5	58.1	59.5	55.7	57.8	52.8	55.3	50.1	52.8	46.2	46.2	42.0	42.0	39.5	39.5	33.2	33.2	26.7	26.7	24.6	24.6	20.6	18.0		10	
12	44.7	50.3	44.7	49.9	44.7	48.1	43.0	46.7	41.1	44.2	39.2	40.2	37.5	37.9	35.8	36.4	30.6	30.6	24.7	24.7	22.9	22.9	19.4	16.9		12	
14	36.1	41.3	36.1	41.4	36.1	41.3	36.0	39.8	34.6	38.3	33.2	35.2	31.7	32.9	30.4	32.6	28.8	28.8	23.1	23.1	21.3	21.3	18.1	15.6		14	
16	30.0	34.5	30.1	34.6	30.0	34.5	29.9	34.4	29.7	33.4	28.5	31.4	27.4	29.1	26.2	28.4	25.1	25.7	21.6	21.6	20.1	20.1	17.2	14.7		16	
18	12.1	12.1	25.6	29.5	25.6	29.5	25.5	29.4	25.3	29.2	24.9	27.9	23.9	26.2	23.0	25.3	22.0	23.2	19.9	19.9	18.6	18.6	16.2	13.8		18	
20			22.1	25.6	22.2	25.6	22.1	25.5	21.8	25.3	21.6	25.1	21.1	23.6	20.3	22.8	19.4	21.2	18.6	18.6	17.4	17.4	15.2	12.9		20	
22					19.4	22.5	19.3	22.4	19.1	22.2	18.9	22.0	18.7	21.5	18.1	20.5	17.3	19.3	16.5	17.5	16.1	16.4	14.3	12.0		22	
24					17.2	20.0	17.1	19.9	16.9	19.7	16.7	19.5	16.4	19.2	16.2	18.7	15.4	17.6	14.8	16.1	14.4	15.4	13.6	11.4		24	
26					15.3	17.9	15.3	17.8	15.1	17.6	14.9	17.4	14.6	17.2	14.4	16.9	13.9	16.1	13.2	14.8	12.9	14.2	12.8	10.8		26	
28							13.7	16.1	13.5	15.9	13.3	15.7	13.1	15.4	12.8	15.2	12.5	14.8	11.9	13.6	11.5	13.1	11.9	10.2		28	
30							12.4	14.6	12.2	14.4	12.0	14.2	11.8	13.9	11.5	13.7	11.3	13.4	10.7	12.6	10.4	12.2	11.1	9.6		30	
32							11.3	13.2	11.1	13.1	10.9	12.9	10.6	12.6	10.4	12.4	10.1	12.1	9.7	11.8	9.4	11.4	10.4	9.1		32	
34									10.1	12.0	9.9	11.8	9.6	11.5	9.4	11.2	9.1	10.9	8.8	10.7	8.5	10.5	9.8	8.7		34	
36									9.2	11.0	9.0	10.8	8.8	10.5	8.5	10.3	8.2	9.9	7.9	9.7	7.7	9.5	9.0	8.3		36	
38									8.4	10.1	8.2	9.9	8.0	9.7	7.7	9.4	7.4	9.1	7.2	8.8	7.0	8.6	8.2	7.8		38	
40											7.5	9.1	7.3	8.9	7.0	8.6	6.7	8.3	6.5	8.0	6.3	7.8	7.4	7.1		40	
42											6.9	8.4	6.6	8.2	6.4	7.9	6.1	7.6	5.8	7.3	5.7	7.1	6.8	6.5		42	
44											6.3	7.7	6.1	7.5	5.8	7.3	5.5	7.0	5.3	6.7	5.1	6.5	6.2	5.9		44	
46													5.5	6.9	5.3	6.7	5.0	6.4	4.7	6.1	4.6	6.0	5.6	5.4		46	
48													5.1	6.4	4.8	6.1	4.5	5.8	4.3	5.6	4.1	5.4	5.1	4.9		48	
50													4.6	5.9	4.4	5.6	4.1	5.4	3.8	5.1	3.7	4.9	4.6	4.4		50	
55																	3.4	4.6	3.1	4.3	2.9	4.0	3.6	3.4		55	
60																			2.3	3.4	2.1	3.1		2.5		60	
65																					2.4		2.2			65	

TLT 10576238 - M188886 Offiziell

Above load charts are for reference only.

For actual lift duty and complete chart with all available configurations please refer to load chart in operator's cab or manual.

L-boom high reach with 40 m main boom (No. 2017/1309.xx)

Working range 86° – 15°

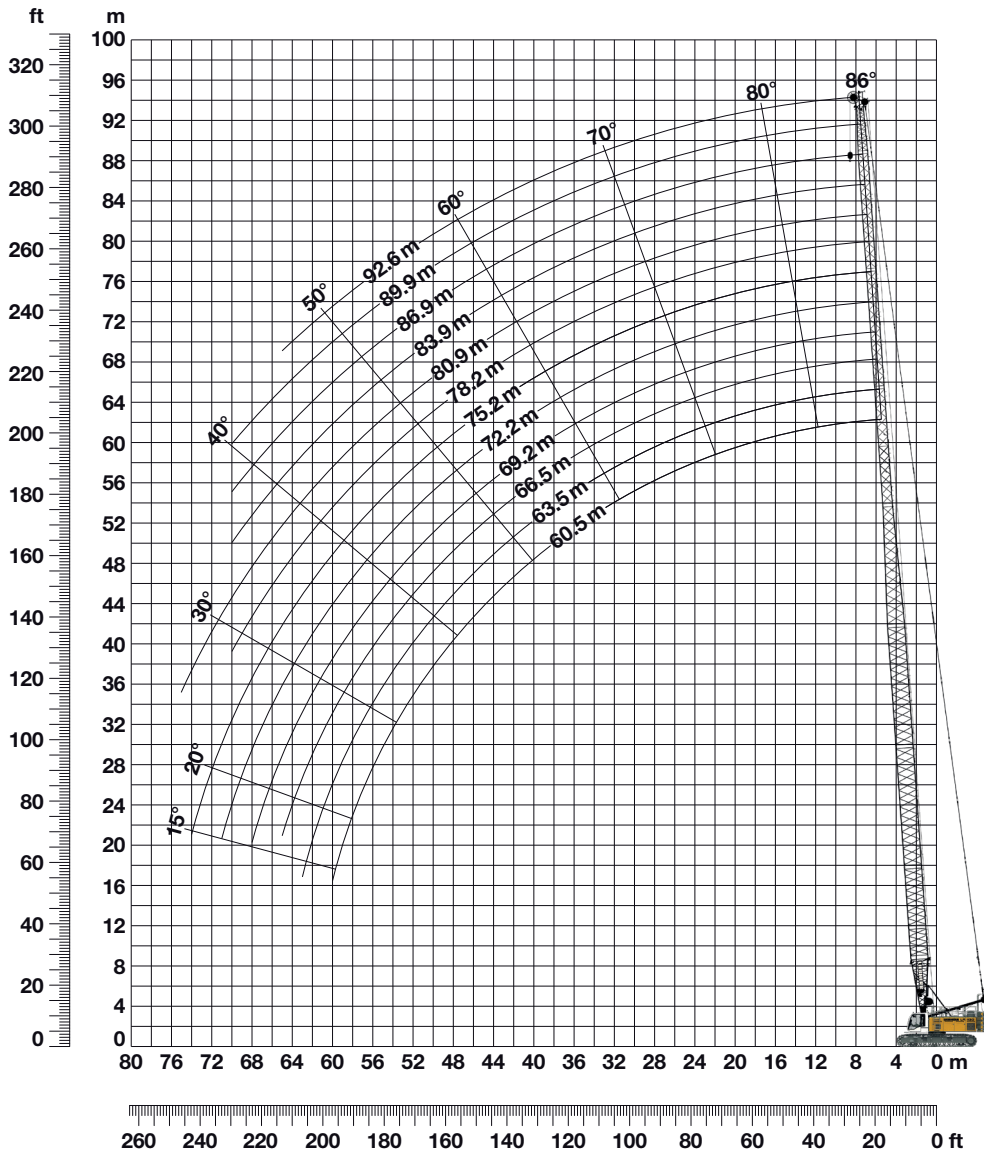

Configuration for L-boom lengths between 60.5 m and 92.6 m (main boom length 40 m)

	Length	Amount of boom and luffing jib extensions												
		60.5	63.5	66.5	69.2	72.2	75.2	78.2	80.9	83.9	86.9	89.9	92.6	
Boom foot	7.0 m	1	1	1	1	1	1	1	1	1	1	1	1	1
Boom insert	3.0 m	1	1	1	1	1	1	1	1	1	1	1	1	1
Boom insert	6.0 m	1	1	1	1	1	1	1	1	1	1	1	1	1
Boom insert	12.0 m	2	2	2	2	2	2	2	2	2	2	2	2	2
Tapered	12.0 m	1	1	1	1	1	1	1	1	1	1	1	1	1
Luffing insert	3.0 m			1			1			1			1	
Luffing insert	6.0 m		1	1			1			1		1	1	
Luffing insert	11.7 m				1	1	1		1	2	2	2	2	3
Luffing jib head	5.5 m	1	1	1	1	1	1	1	1	1	1	1	1	1
Max. L – boom length (m)		60.5	63.5	66.5	69.2	72.2	75.2	78.2	80.9	83.9	86.9	89.9	92.6	

Lift chart for L-boom high reach

Counterweight 32.3 t 42.3 t 52.3 t and 20 t carbody counterweight

Capacities in metric tonnes for boom lengths (60.5 m - 92.6 m) with 120 kN winches

Radius (m)	Boom length in (m)															Radius (m)
	60.5			72.2			80.9			89.9			92.6			
	t	t	t	t	t	t	t	t	t	t	t	t	t	t		
6	40.0	40.0	40.0													6
7	39.5	39.5	39.5	21.9	21.9	21.9										7
8	37.8	37.8	37.8	21.4	21.4	21.4	13.4	13.4	13.4	9.8						8
9	35.8	35.8	35.8	20.7	20.7	20.7	12.8	12.8	12.8	9.6	8.3	8.3	7.3	7.3		9
10	33.7	33.7	33.7	20.0	20.0	20.0	12.3	12.3	12.3	9.4	8.0	8.0	7.0	7.0		10
12	30.1	30.1	30.1	18.7	18.7	18.7	11.4	11.4	11.4	8.8	7.6	7.6	6.6	6.6		12
14	25.8	25.8	25.8	17.6	17.6	17.6	10.6	10.6	10.6	8.2	7.1	7.1	6.2	6.2		14
16	22.7	22.7	22.7	16.5	16.5	16.5	9.9	9.9	9.9	7.7	6.7	6.7	5.9	5.9		16
18	20.0	20.0	20.0	15.7	15.7	15.7	9.3	9.3	9.3	7.2	6.3	6.3	5.5	5.5		18
20	17.8	18.2	18.2	14.7	14.7	14.7	8.8	8.8	8.8	6.8	5.9	5.9	5.2	5.2		20
22	15.9	16.8	16.8	13.9	13.9	13.9	8.2	8.2	8.2	6.4	5.6	5.6	5.0	5.0		22
24	14.3	15.8	15.8	13.2	13.2	13.2	7.8	7.8	7.8	6.1	5.3	5.3	4.7	4.7		24
26	12.9	14.7	14.7	12.2	12.5	12.5	7.4	7.4	7.4	5.8	5.1	5.1	4.5	4.5		26
28	11.7	13.5	13.5	11.0	11.9	11.9	7.0	7.0	7.0	5.5	4.9	4.9	4.3	4.3		28
30	10.5	12.5	12.5	10.1	11.3	11.3	6.5	6.5	6.5	5.1	4.6	4.6	4.0	4.0		30
32	9.5	11.5	11.6	9.2	10.5	10.5	6.2	6.2	6.2	4.8	4.3	4.3	3.8	3.8		32
34	8.7	10.5	10.8	8.4	9.7	9.7	6.0	6.0	6.0	4.5	4.0	4.0	3.5	3.5		34
36	7.9	9.6	10.0	7.7	9.1	9.1	5.7	5.7	5.7	4.3	3.8	3.8	3.3	3.3		36
38	7.2	8.9	9.4	7.0	8.6	8.6	5.5	5.5	5.5	4.1	3.7	3.7	3.2	3.2		38
40	6.6	8.2	8.8	6.4	8.0	8.0	5.3	5.3	5.3	4.0	3.5	3.5	3.0	3.0		40
42	6.1	7.6	8.2	5.9	7.4	7.4	5.2	5.2	5.2	3.8	3.4	3.4	2.9	2.9		42
44	5.6	7.0	7.7	5.4	6.8	7.0	5.0	5.0	5.0	3.7	3.3	3.3	2.8	2.8		44
46	5.1	6.5	7.3	5.0	6.3	6.6	4.7	4.9	4.9	3.6	3.2	3.2	2.8	2.8		46
48	4.7	6.0	6.9	4.5	5.8	6.2	4.4	4.7	4.7	3.5	3.1	3.1	2.7	2.7		48
50	4.3	5.6	6.4	4.2	5.4	5.8	4.0	4.6	4.6	3.4	3.0	3.0	2.6	2.6		50
55	3.5	4.7	5.5	3.4	4.5	5.0	3.2	4.1	4.1	3.0	2.8	2.8	2.4	2.4		55
60	2.8	3.9	4.0	2.7	3.7	4.3	2.5	3.5	3.7	2.4	2.6	2.6	2.3	2.3		60
65				2.1	3.1	3.7		2.9	3.2		2.5	2.5	2.1	2.1		65
70					2.5	3.1		2.3	2.6		2.1	2.3				70
75									2.2							75

TLT 10576238 - M188886 Offiziell

Above load charts are for reference only.

For actual lift duty and complete chart with all available configurations please refer to load chart in operator's cab or manual.

L-boom high reach with 52 m main boom (No. 2017/1309.xx)

Working range 86° – 15°

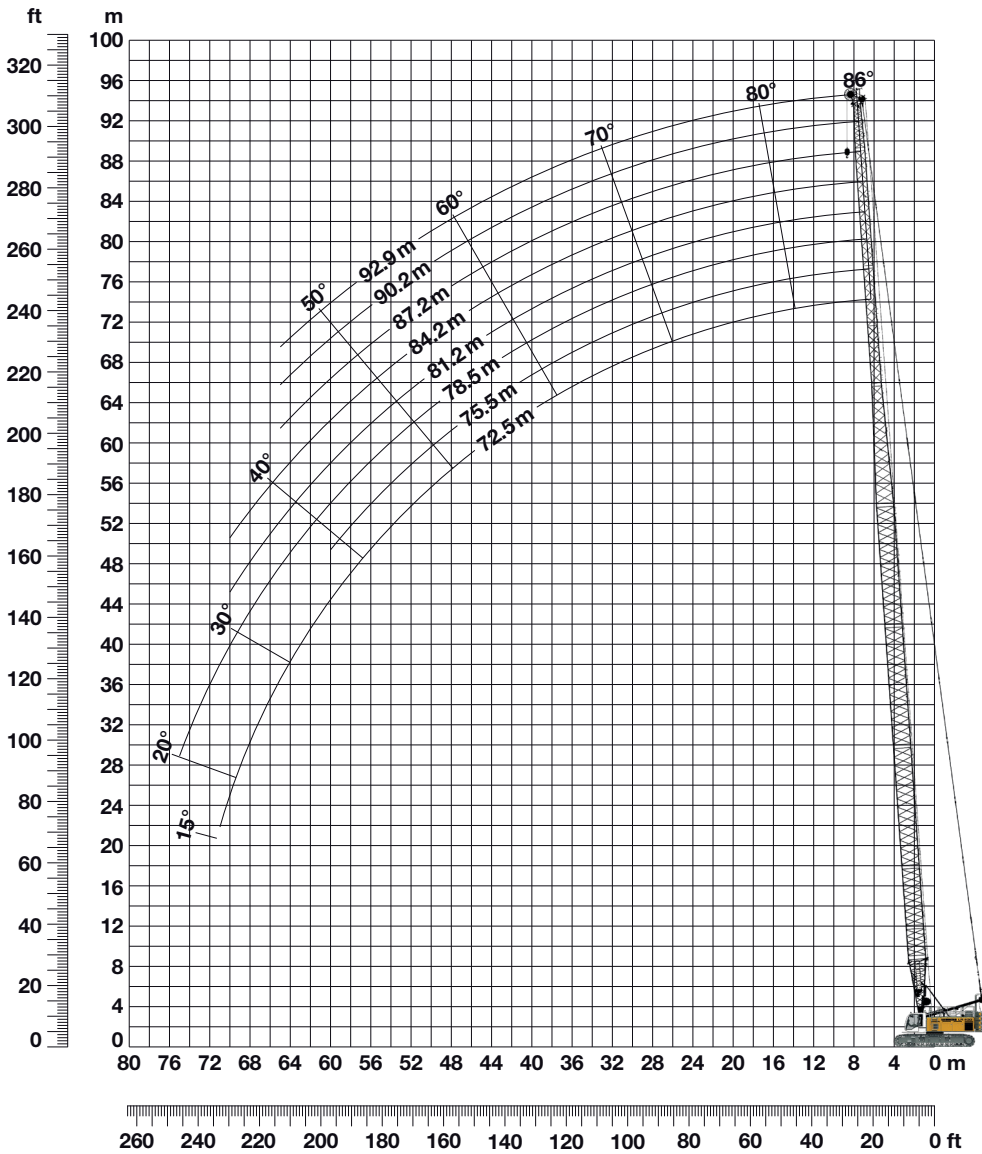

Configuration for L-boom lengths between 72.5 m and 92.9 m (main boom length 52 m)

Component	Length	Amount of boom and luffing jib extensions							
		72.5	75.5	78.5	81.2	84.2	87.2	90.2	92.9
Boom foot	7.0 m	1	1	1	1	1	1	1	1
Boom insert	3.0 m	1	1	1	1	1	1	1	1
Boom insert	6.0 m	1	1	1	1	1	1	1	1
Boom insert	12.0 m	3	3	3	3	3	3	3	3
Tapered	12.0 m	1	1	1	1	1	1	1	1
Luffing insert	3.0 m	1		1		1		1	
Luffing insert	6.0 m		1	1			1	1	
Luffing insert	11.7 m				1	1	1	1	2
Luffing jib head	5.5 m	1	1	1	1	1	1	1	1
Max. L – boom length (m)		72.5	75.5	78.5	81.2	84.2	87.2	90.2	92.9

Lift chart for L-boom high reach

Counterweight **32.3 t** **42.3 t** **52.3 t** and 20 t carbody counterweight

Capacities in metric tonnes for boom lengths (72.5 m - 92.9 m) with 120 kN winches

Radius (m)	Boom length in (m)												Radius (m)	
	72.5			78.5			84.2			90.2		92.9		
	t	t	t	t	t	t	t	t	t	t	t	t	t	
6.9	26.5	26.5	26.5											6.9
7	26.5	26.5	26.5											7
8	26.1	26.1	26.1	20.4	20.4	20.4	16.0	16.0	16.0					8
9	25.3	25.3	25.3	20.1	20.1	20.1	15.8	15.8	15.8	11.9	11.9	10.1	10.1	9
10	24.5	24.5	24.5	19.7	19.7	19.7	15.5	15.5	15.5	11.7	11.7	9.8	9.8	10
12	22.9	22.9	22.9	18.9	18.9	18.9	14.6	14.6	14.6	11.1	11.1	9.1	9.1	12
14	21.5	21.5	21.5	17.8	17.8	17.8	13.8	13.8	13.8	10.5	10.5	8.6	8.6	14
16	19.2	19.2	19.2	16.7	16.7	16.7	13.1	13.1	13.1	10.0	10.0	8.0	8.0	16
18	17.7	17.7	17.7	15.6	15.6	15.6	12.4	12.4	12.4	9.4	9.4	7.6	7.6	18
20	15.6	15.6	15.6	14.5	14.5	14.5	11.8	11.8	11.8	8.9	8.9	7.1	7.1	20
22	14.1	14.1	14.1	13.1	13.1	13.1	10.9	10.9	10.9	8.6	8.6	6.8	6.8	22
24	13.0	13.1	13.1	12.0	12.0	12.0	10.2	10.2	10.2	8.2	8.2	6.5	6.5	24
26	11.7	12.2	12.2	11.2	11.2	11.2	9.6	9.6	9.6	7.9	7.9	6.2	6.2	26
28	10.5	11.5	11.5	10.1	10.5	10.5	9.1	9.1	9.1	7.6	7.6	5.9	5.9	28
30	9.5	11.0	11.0	9.1	10.0	10.0	8.7	8.7	8.7	7.3	7.3	5.7	5.7	30
32	8.6	10.1	10.1	8.3	9.6	9.6	7.9	8.4	8.4	6.9	6.9	5.3	5.3	32
34	7.9	9.3	9.3	7.5	8.8	8.8	7.2	8.1	8.1	6.6	6.6	5.0	5.0	34
36	7.2	8.7	8.7	6.9	8.1	8.1	6.6	7.5	7.5	6.4	6.4	4.8	4.8	36
38	6.6	8.1	8.1	6.3	7.6	7.6	6.0	6.9	6.9	6.1	6.1	4.6	4.6	38
40	6.0	7.5	7.5	5.7	7.1	7.1	5.5	6.4	6.4	5.7	5.7	4.5	4.5	40
42	5.5	7.0	7.0	5.2	6.6	6.6	5.0	6.0	6.0	5.4	5.4	4.3	4.3	42
44	5.0	6.4	6.6	4.8	6.2	6.2	4.6	5.6	5.6	5.1	5.1	4.2	4.2	44
46	4.5	5.9	6.2	4.4	5.7	5.7	4.2	5.2	5.2	4.9	4.9	4.1	4.1	46
48	4.1	5.4	5.8	4.0	5.3	5.4	3.8	4.8	4.8	4.6	4.6	4.0	4.0	48
50	3.8	5.0	5.4	3.7	4.9	5.1	3.5	4.5	4.5	4.2	4.2	3.7	3.7	50
55	3.0	4.1	4.6	2.8	4.0	4.2	2.8	3.8	3.8	3.5	3.5	3.3	3.3	55
60	2.3	3.3	3.9	2.2	3.2	3.6	2.1	3.1	3.2	2.9	2.9	2.9	2.9	60
65		2.7	3.3		2.5	3.0		2.4	2.7	2.3	2.3	2.2	2.2	65
70		2.1	2.7			2.5			2.1					70
75						2.0								75

TLT 10576238 - M188886 Offiziell

Above load charts are for reference only.

For actual lift duty and complete chart with all available configurations please refer to load chart in operator's cab or manual.

Working range - luffing jib 78° - 15° (No. 1309.xx)

Main boom 88° - 45°

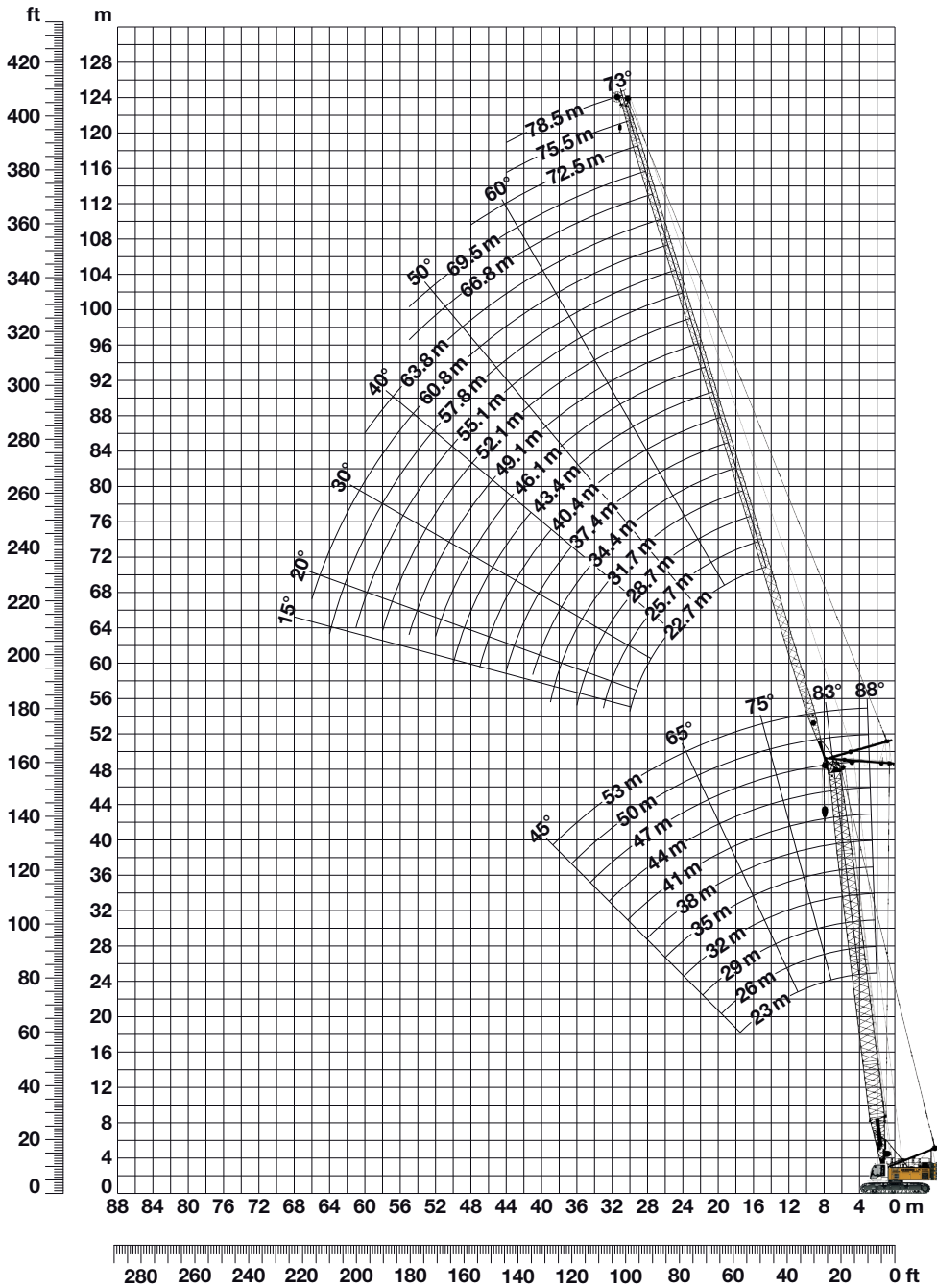

Boom configuration for main boom lengths (23 m - 53 m) (see table 1 on page 10)
Jib configuration for jib lengths (22.7 m - 78.5 m)

	Length	Amount of luffing jib extensions																			
		1	1	1	1	1	1	1	1	1	1	1	1	1	1	1	1	1	1	1	
Luffing jib foot	5.5 m	1	1	1	1	1	1	1	1	1	1	1	1	1	1	1	1	1	1	1	
Luffing jib insert	3.0 m		1		1		1		1		1		1		1		1		1		
Luffing jib insert	6.0 m			1	1		1		1		1		1		1		1		1		
Luffing jib insert	11.7 m	1	1	1	1	2	2	2	2	3	3	3	3	4	4	4	4	5	5	5	5
Luffing jib head	5.5 m	1	1	1	1	1	1	1	1	1	1	1	1	1	1	1	1	1	1	1	1
Luffing jib length (m)		22.7	25.7	28.7	31.7	34.4	37.4	40.4	43.4	46.1	49.1	52.1	55.1	57.8	60.8	63.8	66.8	69.5	72.5	75.5	78.5

Lift chart - luffing jib (No. 1309.xx)

Main boom 88°

TLT 10576238 M188886 Offiziell

Main boom 23 m

Radius (m)	Jib length in (m)							
	22.7	28.7	34.4	40.4	49.1	60.8	69.5	78.5
	t	t	t	t	t	t	t	t
8.2	43.3							
10	38.5	33.8						
11	35.5	31.9	26.3					
12	33.2	29.9	25.6	20.3				
14	29.2	26.4	23.5	19.5	13.3			
17	24.2	22.3	20.1	17.7	12.4	8.4		
18	23.0	21.1	19.1	17.2	12.1	8.2	5.8	
20	20.6	19.1	17.5	15.7	11.5	7.9	5.6	3.6
22	18.8	17.6	16.0	14.6	11.0	7.5	5.4	3.5
24	17.2	16.2	14.7	13.6	10.4	7.3	5.2	3.3
30		13.1	12.0	11.4	9.2	6.7	4.8	2.9
36			10.3	9.9	8.2	6.2	4.5	2.6
42				7.9	7.1	5.9	4.2	2.4
50					5.6	4.9	3.8	2.1
55						4.4	3.6	2.0
60						3.8	3.4	

Main boom 32 m

Radius (m)	Jib length in (m)							
	22.7	28.7	34.4	40.4	49.1	60.8	69.5	78.5
	t	t	t	t	t	t	t	t
8.5	36.1							
10	33.6	28.8						
11	31.3	27.5	23.2					
13	27.7	24.6	21.8	17.8				
15	24.8	22.2	19.8	17.0	12.2			
17	22.2	20.2	18.2	15.7	11.7	7.9		
19	20.1	18.2	16.7	14.6	11.1	7.6	5.5	
22	17.0	15.9	14.6	13.0	10.4	7.2	5.2	3.3
24	15.4	14.3	13.3	12.1	9.9	6.9	5.0	3.2
28		12.0	11.4	10.5	9.1	6.6	4.7	2.9
30		11.2	10.5	9.9	8.6	6.4	4.6	2.8
36			8.7	7.9	7.5	5.9	4.3	2.5
42				6.6	6.1	5.5	4.0	2.3
50					4.9	4.2	3.5	2.1
60						3.1	2.6	
65							2.2	

Main boom 38 m

Radius (m)	Jib length in (m)							
	22.7	28.7	34.4	40.4	49.1	60.8	69.5	78.5
	t	t	t	t	t	t	t	t
8.8	31.5							
10	29.8	25.4						
12	26.5	23.5	20.5					
13	24.8	22.1	19.6	16.4				
15	22.3	20.0	17.9	15.4	11.4			
17	19.9	18.2	16.5	14.2	10.9	7.5		
19	18.0	16.5	15.1	13.2	10.4	7.2	5.2	
22	15.2	14.4	13.4	11.7	9.7	6.8	5.0	3.2
24	14.0	13.2	12.3	10.9	9.2	6.6	4.8	3.1
28		11.3	10.6	9.6	8.4	6.3	4.6	2.8
30		10.7	9.9	9.1	8.0	6.1	4.4	2.7
34			8.8	7.9	7.3	5.8	4.2	2.5
36			8.3	7.4	6.9	5.5	4.1	2.5
42				6.3	5.7	5.0	3.8	2.3
50					4.6	3.8	3.3	2.0
60						2.9	2.3	

Main boom 47 m

Radius (m)	Jib length in (m)							
	22.7	28.7	34.4	40.4	49.1	60.8	69.5	78.5
	t	t	t	t	t	t	t	t
9.1	25.0							
11	22.7	20.1						
12	21.4	19.0	16.7					
13	20.2	18.0	15.9	13.6				
15	18.1	16.3	14.4	12.7	10.0			
18	15.4	14.3	12.5	11.2	9.3	6.6		
19	14.8	13.6	11.9	10.8	8.9	6.5	4.8	
22	13.2	11.9	10.6	9.6	8.2	6.1	4.6	3.0
26	9.8	10.5	9.3	8.5	7.3	5.6	4.3	2.8
32		7.1	8.0	7.3	6.3	5.0	3.9	2.5
36			7.2	6.6	5.8	4.6	3.7	2.3
42				5.7	4.9	4.0	3.2	2.1
44					4.7	3.9	3.0	2.0
50					4.1	3.2	2.6	
55						2.8	2.2	
60						2.4		

Main boom 50 m

Radius (m)	Jib length in (m)						
	22.7	28.7	34.4	40.4	49.1	60.8	69.5
	t	t	t	t	t	t	t
9.2	22.8						
11	20.9	18.4					
12	19.6	17.4	15.3				
13	18.6	16.4	14.6	12.5			
15	16.7	14.8	13.2	11.7	9.3		
18	14.4	12.8	11.5	10.4	8.7	6.3	
19	13.8	12.1	11.0	10.0	8.3	6.2	4.6
20	13.3	11.5	10.6	9.6	8.0	6.0	4.6
22	12.4	10.6	9.8	8.8	7.5	5.7	4.4
24	11.7	10.0	9.1	8.3	7.1	5.4	4.2
26	8.9	9.5	8.6	7.8	6.7	5.2	4.0
32		7.0	7.6	6.8	5.8	4.5	3.6
36			6.9	6.3	5.4	4.2	3.3
42				5.5	4.6	3.7	2.9
50					3.9	2.9	2.4
60						2.2	

Main boom 53 m

Radius (m)	Jib length in (m)							
	22.7	25.7	28.7	31.7	34.4	37.4	40.4	49.1
	t	t	t	t	t	t	t	t
9.3	20.8							
10	20.4	18.6						
11	19.2	17.8	16.9					
12	18.1	16.9	15.9	15.0	14.0			
13	17.1	15.9	15.1	14.2	13.4	12.5	11.4	
15	15.5	14.2	13.6	12.9	12.2	11.5	10.8	8.7
18	13.3	12.3	11.8	11.1	10.7	10.1	9.6	8.0
20	12.3	11.2	10.7	10.3	9.8	9.2	8.8	7.4
26	10.1	9.3	8.8	8.4	8.0	7.6	7.2	6.2
28		8.8	8.4	8.0	7.6	7.2	6.8	5.9
32			6.5	7.4	7.0	6.6	6.3	5.3
34				7.0	6.8	6.4	6.0	5.1
36					6.5	6.1	5.8	4.9
40						4.8	5.4	4.5
42							5.1	4.3
50								3.6

Capacities in metric tonnes with luffing jib (No. 1309.xx), 52.3 t counterweight + 20 t carbody counterweight. Above lift chart is for reference only. For actual lift duty and complete chart with all available configurations please refer to lift chart in operator's cab or manual.

Lift chart - luffing jib (No. 1309.xx)

Main boom 83°

TLT 10576238 M188886 Offiziell

Main boom 23 m

Radius (m)	Jib length in (m)							
	22.7 t	28.7 t	34.4 t	40.4 t	49.1 t	60.8 t	69.5 t	78.5 t
12.2	37.6							
14	33.7	30.2						
16	29.1	27.1	24.0					
18	25.5	23.9	22.1	18.3				
20	22.9	21.5	19.8	17.5	11.8			
24	18.7	17.9	16.5	15.1	10.9	7.5		
26	17.4	16.5	15.2	14.2	10.6	7.2	5.1	
30		14.5	13.3	12.6	9.9	6.9	4.9	3.0
32		13.7	12.5	11.9	9.5	6.7	4.8	2.9
36			11.4	10.6	8.9	6.4	4.6	2.7
38			10.9	10.1	8.5	6.3	4.5	2.6
44				8.8	7.6	6.0	4.2	2.4
50					6.7	5.5	3.9	2.2
55						5.1	3.7	2.1
60						4.6	3.5	
70							3.1	

Main boom 32 m

Radius (m)	Jib length in (m)							
	22.7 t	28.7 t	34.4 t	40.4 t	49.1 t	60.8 t	69.5 t	78.5 t
13.3	30.6							
15	28.1	24.7						
17	25.2	22.8	20.2					
19	22.5	20.5	18.7	15.9				
22	19.5	17.7	16.4	14.5	10.9			
26	16.6	15.2	14.1	12.7	10.0	7.0		
28	15.4	14.3	13.3	11.9	9.7	6.8	4.9	
30		13.5	12.6	11.3	9.4	6.7	4.7	2.9
34		11.3	11.3	10.2	8.7	6.4	4.5	2.7
38			10.1	9.2	8.2	6.1	4.3	2.5
40				8.8	7.8	6.0	4.2	2.5
44				7.7	7.2	5.7	4.0	2.3
50					6.2	5.2	3.8	2.1
55						4.8	3.6	2.0
65						3.4	3.0	
70							2.6	

Main boom 38 m

Radius (m)	Jib length in (m)							
	22.7 t	28.7 t	34.4 t	40.4 t	49.1 t	60.8 t	69.5 t	78.5 t
14	24.9							
16	22.6	20.3						
18	20.2	18.5	16.8					
20	18.1	16.7	15.4	13.5				
22	16.5	15.3	14.1	12.4	10.0			
26	14.2	13.1	12.2	10.8	9.1	6.6		
28	13.4	12.4	11.5	10.2	8.7	6.5	4.7	
32		11.2	10.4	9.3	8.1	6.1	4.5	2.8
34		10.6	9.9	8.8	7.7	5.9	4.4	2.7
36			9.5	8.4	7.4	5.8	4.3	2.6
40			8.6	7.7	6.8	5.4	4.1	2.4
42				7.4	6.5	5.2	3.9	2.3
46				6.3	6.0	4.9	3.7	2.2
50					5.5	4.5	3.5	2.1
65						3.1	2.6	
70							2.2	

Main boom 47 m

Radius (m)	Jib length in (m)							
	22.7 t	28.7 t	34.4 t	40.4 t	49.1 t	60.8 t	69.5 t	78.5 t
15.1	18.3							
17	16.8	15.1						
19	15.1	13.9	12.2					
22	13.1	12.1	10.7	9.8				
24	12.2	11.1	9.8	9.0	7.7			
28	10.9	9.9	8.7	8.0	6.9	5.3		
30	10.3	9.4	8.3	7.5	6.5	5.1	4.1	
32		9.1	7.9	7.2	6.3	4.9	3.9	2.6
34		8.6	7.6	6.9	5.9	4.6	3.7	2.6
36		7.4	7.3	6.6	5.7	4.4	3.5	2.5
40			6.7	6.1	5.2	4.0	3.2	2.3
44				5.7	4.8	3.7	2.9	2.0
46				5.4	4.6	3.5	2.8	
48					4.5	3.4	2.6	
55					3.8	2.9	2.2	
65						2.3		

Main boom 50 m

Radius (m)	Jib length in (m)							
	22.7 t	28.7 t	34.4 t	40.4 t	49.1 t	55.1 t	60.8 t	69.5 t
15.5	16.4							
18	14.6	13.0						
19	13.9	12.3	11.0					
22	12.0	10.7	9.8	8.9				
24	11.3	9.8	9.0	8.2	7.0			
26	10.7	9.1	8.5	7.7	6.6	5.8		
28	10.2	8.7	7.9	7.3	6.2	5.5	4.8	
30	9.6	8.3	7.6	6.9	5.9	5.3	4.6	3.6
36		6.8	6.7	6.0	5.1	4.6	4.0	3.1
38			6.5	5.8	4.9	4.3	3.8	3.0
42			5.4	5.4	4.5	3.9	3.4	2.7
46				5.0	4.2	3.6	3.1	2.4
50					3.9	3.3	2.8	2.1
55					3.5	3.0	2.5	
60						2.7	2.3	
65							2.0	

Main boom 53 m

Radius (m)	Jib length in (m)							
	22.7 t	25.7 t	28.7 t	31.7 t	34.4 t	37.4 t	40.4 t	49.1 t
15.9	14.8							
17	14.2	13.0						
18	13.5	12.4	11.8					
19	12.8	11.8	11.2	10.7				
20	12.2	11.1	10.7	10.2	9.8			
22	11.1	10.2	9.7	9.3	9.0	8.5	8.1	
24	10.4	9.4	9.0	8.6	8.2	7.8	7.5	6.3
28	9.4	8.4	8.0	7.6	7.3	6.9	6.6	5.7
30	8.9	8.1	7.7	7.2	6.9	6.5	6.2	5.3
32		7.7	7.4	7.0	6.6	6.2	5.9	5.1
36			6.7	6.5	6.2	5.8	5.5	4.6
38				6.2	5.9	5.6	5.3	4.4
42					4.9	5.2	4.9	4.0
44						4.9	4.7	3.9
48							3.8	3.6
55								3.1

Capacities in metric tonnes with luffing jib (No. 1309.xx), 52.3 t counterweight + 20 t carbody counterweight. Above lift chart is for reference only. For actual lift duty and complete chart with all available configurations please refer to lift chart in operator's cab or manual.

Lift chart - luffing jib (No. 1309.xx)

Main boom 75°

TLT 10576238 M188886 Offiziell

Main boom 23 m

Radius (m)	Jib length in (m)							
	22.7 t	28.7 t	34.4 t	40.4 t	49.1 t	60.8 t	69.5 t	78.5 t
18.3	27.9							
22	23.3	22.7						
24	21.0	20.8	19.7					
26	19.0	18.8	17.9	16.2				
30	15.9	15.8	15.3	14.8	10.3			
36		12.5	12.4	12.1	9.5	6.6		
40			10.8	10.6	9.0	6.4	4.5	
42				10.0	8.6	6.2	4.4	2.5
44				9.4	8.3	6.1	4.3	2.5
46				8.8	8.0	6.0	4.2	2.4
48					7.8	5.9	4.1	2.3
50					7.4	5.8	4.0	2.3
55					6.6	5.5	3.8	2.1
60						5.1	3.6	
65						4.5	3.5	
75							3.1	

Main boom 32 m

Radius (m)	Jib length in (m)							
	22.7 t	28.7 t	34.4 t	40.4 t	49.1 t	60.8 t	69.5 t	78.5 t
20.7	21.8							
24	19.0	17.8						
26	17.6	16.5	15.6					
30	15.3	14.3	13.7	12.6				
32	14.1	13.5	12.9	11.9	9.5			
38		11.2	10.9	10.0	8.8	6.3		
42			9.7	9.0	8.1	6.1	4.3	
44			9.1	8.6	7.8	5.9	4.2	
46				8.3	7.5	5.8	4.1	2.4
48				7.9	7.2	5.7	4.0	2.3
50				7.3	6.9	5.6	3.9	2.2
55					6.2	5.2	3.8	2.1
60						4.8	3.6	
65						4.4	3.4	
70							3.2	
75							3.0	

Main boom 38 m

Radius (m)	Jib length in (m)							
	22.7 t	28.7 t	34.4 t	40.4 t	49.1 t	60.8 t	69.5 t	78.5 t
22.2	17.4							
26	15.0	14.1						
28	14.0	13.2	12.4					
30	13.1	12.4	11.7	10.3				
34	12.0	11.1	10.5	9.4	8.2			
40		9.7	9.0	8.1	7.2	5.5		
42			8.7	7.7	6.9	5.4	3.9	
44			8.3	7.4	6.7	5.3	3.9	
46				7.1	6.4	5.2	3.8	2.3
48				6.9	6.1	5.0	3.7	2.3
50				6.6	5.9	4.8	3.7	2.2
55					5.3	4.4	3.4	2.1
60					4.5	3.9	3.1	
65						3.6	2.8	
70						3.2	2.6	
75							2.3	

Main boom 47 m

Radius (m)	Jib length in (m)							
	22.7 t	28.7 t	34.4 t	40.4 t	49.1 t	60.8 t	69.5 t	78.5 t
24.6	11.9							
28	10.7	10.0						
30	10.1	9.4	8.4					
32	9.5	8.8	7.9	7.2				
34	9.1	8.3	7.5	6.9				
36	8.7	7.9	7.1	6.6	5.7			
38		7.5	6.7	6.2	5.4			
40		7.3	6.4	5.9	5.2			
42		7.0	6.1	5.6	4.9	3.9		
44			5.9	5.3	4.7	3.7		
46			5.7	5.1	4.5	3.5	2.8	
48			5.0	4.9	4.3	3.4	2.7	
50				4.8	4.0	3.2	2.5	
55					3.6	2.8	2.1	
60						3.3	2.4	
65							2.1	

Main boom 50 m

Radius (m)	Jib length in (m)							
	22.7 t	28.7 t	34.4 t	40.4 t	49.1 t	55.1 t	60.8 t	69.5 t
25.3	10.3							
28	9.6	8.4						
30	9.0	7.9						
32	8.5	7.5	6.9					
34	8.0	7.1	6.5	6.0				
36	7.8	6.7	6.2	5.7				
38		6.3	5.9	5.4	4.7			
40		6.1	5.6	5.1	4.4	4.0		
42		5.9	5.3	4.9	4.2	3.8	3.2	
44			5.1	4.6	4.0	3.6	3.1	
46			5.0	4.4	3.8	3.4	2.9	2.2
48			4.8	4.2	3.6	3.2	2.8	2.1
50				4.1	3.4	3.0	2.6	
55					3.0	2.6	2.2	
60					2.8	2.3		
65						2.1		

Main boom 53 m

Radius (m)	Jib length in (m)							
	22.7 t	25.7 t	28.7 t	31.7 t	34.4 t	37.4 t	40.4 t	49.1 t
26.1	9.0							
28	8.5	7.8						
30	8.0	7.3	7.0	6.6				
32	7.5	6.8	6.6	6.3	6.1			
34	7.1	6.5	6.2	5.9	5.7	5.5	5.1	
36	6.9	6.1	5.9	5.6	5.4	5.1	4.9	
38	6.7	5.9	5.6	5.3	5.1	4.8	4.6	3.9
40		5.7	5.4	5.1	4.9	4.6	4.4	3.7
42			5.2	4.8	4.6	4.4	4.2	3.5
44			4.5	4.7	4.4	4.1	4.0	3.3
46				4.6	4.3	4.0	3.8	3.1
48					4.2	3.9	3.6	3.0
50						3.7	3.5	2.8
55							2.9	2.5
60								2.3

Capacities in metric tonnes with luffing jib (No. 1309.xx), 52.3 t counterweight + 20 t carbody counterweight. Above lift chart is for reference only. For actual lift duty and complete chart with all available configurations please refer to lift chart in operator's cab or manual.

Lift chart - luffing jib (No. 1309.xx)

Main boom 65°

TLT 10576238 M188886 Offiziell

Main boom 23 m

Radius (m)	Jib length in (m)							
	22.7 t	28.7 t	34.4 t	40.4 t	49.1 t	60.8 t	69.5 t	78.5 t
25.6	18.3							
28	16.3							
30	15.0	14.7						
32	13.8	13.6						
34	12.8	12.6	12.4					
36		11.7	11.6	11.3				
40		10.2	10.1	9.8				
42			9.5	9.2	8.7			
44			8.9	8.7	8.3			
48				7.7	7.3	6.0		
50				7.3	6.9	5.9		
55					6.0	5.6	3.9	
60						4.8	3.8	2.0
65						4.2	3.6	
70						3.6	3.3	
75							2.9	

Main boom 32 m

Radius (m)	Jib length in (m)							
	22.7 t	28.7 t	34.4 t	40.4 t	49.1 t	60.8 t	69.5 t	
29.4	14.3							
32	12.8							
34	11.9	11.6						
36	11.1	10.8	10.6					
38	10.3	10.1	9.9					
40		9.4	9.2	8.9				
42		8.8	8.6	8.4				
44		8.3	8.1	7.9				
46			7.6	7.4	7.0			
48			7.2	7.0	6.6			
50				6.6	6.2			
55				5.7	5.3	4.9		
60					4.7	4.2	3.6	
65						3.6	3.2	
70						3.1	2.8	
75						2.7	2.4	

Main boom 38 m

Radius (m)	Jib length in (m)							
	22.7 t	28.7 t	34.4 t	40.4 t	49.1 t	60.8 t	69.5 t	
31.9	12.1							
34	11.2							
36	10.4	10.1						
38	9.7	9.4						
40	9.0	8.8	8.6					
42		8.3	8.0	7.7				
44		7.7	7.5	7.2				
46		7.3	7.1	6.8				
48			6.7	6.4	5.9			
50			6.3	6.0	5.6			
55				5.2	4.8	4.2		
60					4.2	3.6	3.1	
65					3.6	3.1	2.6	
70						2.7	2.2	
75						2.3		

Main boom 47 m

Radius (m)	Jib length in (m)							
	22.7 t	28.7 t	34.4 t	40.4 t	49.1 t	60.8 t		
35.7	9.2							
36	9.1							
38	8.6							
40	8.0	7.6						
42	7.5	7.2						
44	7.1	6.8	6.4					
46		6.4	6.0	5.6				
48		6.0	5.7	5.3				
50		5.7	5.4	5.0				
55			4.7	4.4	3.8			
60				3.9	3.3	2.6		
65					2.9	2.2		
70					2.5			

Main boom 50 m

Radius (m)	Jib length in (m)							
	22.7 t	28.7 t	34.4 t	40.4 t	49.1 t	60.8 t		
37	8.3							
40	7.6							
42	7.1	6.7						
44	6.7	6.3	5.9					
46		6.0	5.6					
48		5.6	5.3	4.8				
50		5.3	5.0	4.6				
55			4.4	4.0	3.4			
60				3.5	2.9	2.2		
65					2.5			
70					2.2			

Main boom 53 m

Radius (m)	Jib length in (m)							
	22.7 t	25.7 t	28.7 t	31.7 t	34.4 t	37.4 t	40.4 t	49.1 t
38.2	7.4							
40	7.1	6.5						
42	6.7	6.2	6.0					
44	6.3	6.0	5.7	5.4				
46	5.9	5.7	5.5	5.2	5.0			
48		5.4	5.2	5.0	4.8	4.5		
50		5.0	4.9	4.7	4.6	4.3	4.1	
55				4.1	4.0	3.8	3.6	3.0
60						3.3	3.1	2.6
65								2.2

Capacities in metric tonnes with luffing jib (No. 1309.xx), 52.3 t counterweight + 20 t carbody counterweight. Above lift chart is for reference only. For actual lift duty and complete chart with all available configurations please refer to lift chart in operator's cab or manual.

Lift chart - luffing jib (No. 1309.xx)

Main boom 45°

TLT 10576238 M188886 Offiziell

Main boom 23 m

Radius (m)	Jib length in (m)					
	22.7 t	28.7 t	34.4 t	40.4 t	49.1 t	60.8 t
37.6	10.0					
40	9.2					
44		7.9				
46		7.4				
48			6.8			
50			6.4			
55				5.3		
60					4.3	
65					3.7	
70						2.8
75						2.4

Main boom 32 m

Radius (m)	Jib length in (m)				
	22.7 t	28.7 t	34.4 t	40.4 t	49.1 t
43.9	6.9				
44	6.9				
46	6.5				
50		5.5			
55			4.5		
60				3.7	
70					2.4

Main boom 38 m

Radius (m)	Jib length in (m)			
	22.7 t	28.7 t	34.4 t	40.4 t
48	5.2			
50	4.9			
55		4.0		
60			3.2	
65				2.5

Main boom 47 m

Radius (m)	Jib length in (m)		
	22.7 t	28.7 t	
54.5	3.1		
55	3.0		
60		2.3	

Capacities in metric tonnes with luffing jib (No. 1309.xx), 52.3 t counterweight + 20 t carbody counterweight. Above lift chart is for reference only. For actual lift duty and complete chart with all available configurations please refer to lift chart in operator's cab or manual.

Working range - fixed jib 15° and 30°

(No. 0806.xx)

Main boom 88° – 30°

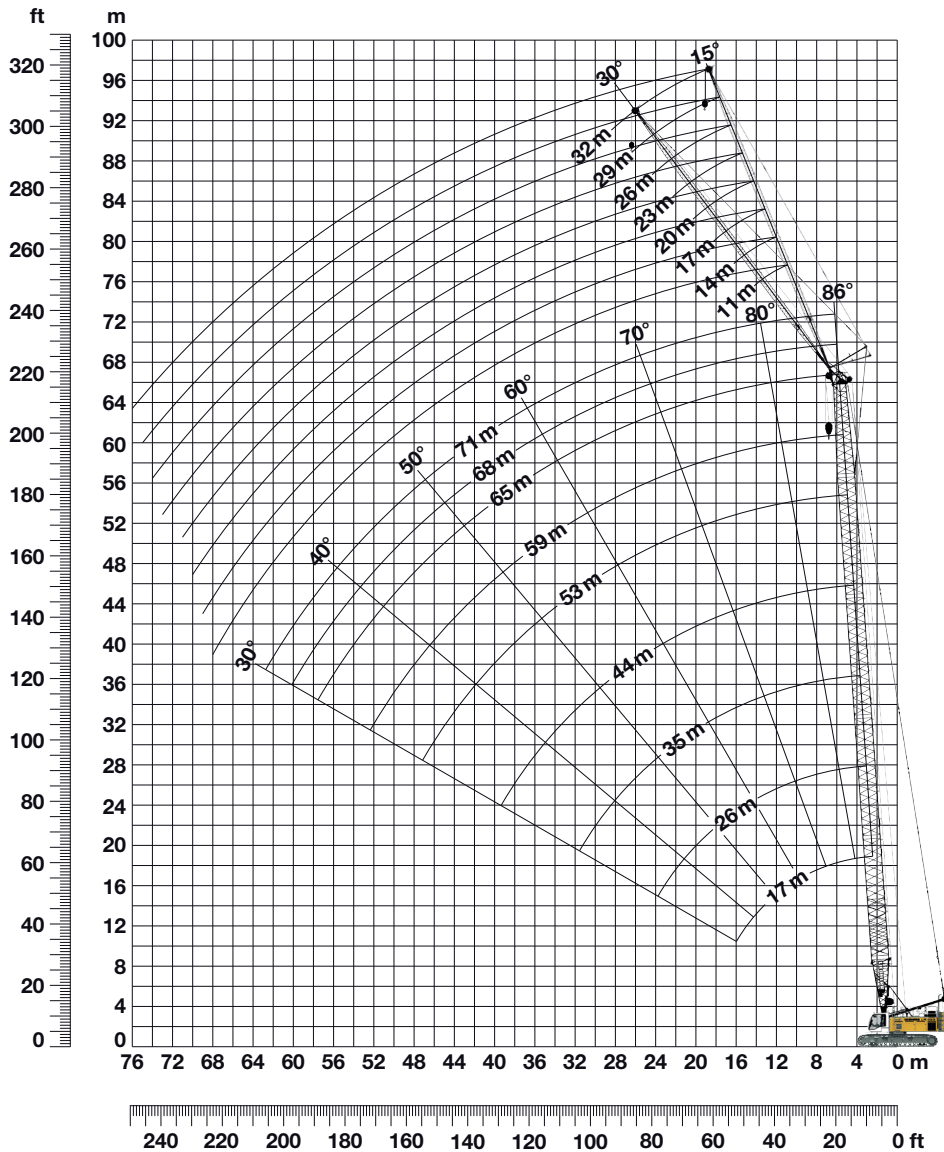

Boom configuration for boom lengths (17 m – 71 m) – see table 1 on page 10

Fixed jib configuration for fixed jib lengths (11 m – 32 m)

	Length	Amount of fixed jib extensions							
Fixed jib foot	5.5 m	1	1	1	1	1	1	1	1
Fixed jib insert	3.0 m		1		1		1		1
Fixed jib insert	6.0 m			1	1	2	2	3	3
Fixed jib head	5.5 m	1	1	1	1	1	1	1	1
Fixed jib length (m)		11	14	17	20	23	26	29	32

Lift chart - fixed jib (No. 0806.xx)

Offset 15°

TLT 10576238 M188886 Offiziell

Main boom 17 m

Radius (m)	Fixed jib length in (m)			
	11 t	20 t	26 t	32 t
5.5	24.0			
10	24.0	14.2		
12	23.6	13.4	8.6	
15	22.5	12.3	7.9	5.0
16	22.0	11.9	7.7	4.9
18	21.1	11.3	7.3	4.7
20	19.4	10.8	7.0	4.5
24	16.8	9.7	6.4	4.2
26	15.6	9.2	6.2	4.1
36		7.5	5.5	3.6
42			5.3	3.5
48				3.3

Main boom 26 m

Radius (m)	Fixed jib length in (m)			
	11 t	20 t	26 t	32 t
5.8	24.0			
10	24.0	14.3		
12	24.0	13.6	8.7	
15	22.9	12.6	8.1	4.9
18	21.8	11.9	7.5	4.7
22	20.3	10.9	7.0	4.4
28	16.8	9.8	6.4	4.0
32	14.0	9.1	6.1	3.9
34	12.8	8.8	6.0	3.8
44		7.5	5.5	3.5
50			5.3	3.4
55				3.3

Main boom 35 m

Radius (m)	Fixed jib length in (m)			
	11 t	20 t	26 t	32 t
6.1	24.0			
10	24.0	13.6		
13	23.7	12.8	8.1	
15	23.2	12.3	7.8	4.9
18	21.8	11.5	7.4	4.7
24	19.3	10.4	6.7	4.3
32	13.6	9.4	6.1	3.9
40	9.7	8.4	5.7	3.7
42	9.0	8.2	5.6	3.6
50		7.2	5.3	3.5
55			5.2	3.4
60				3.3

Main boom 44 m

Radius (m)	Fixed jib length in (m)			
	11 t	20 t	26 t	32 t
6.4	24.0			
11	23.9	13.2		
13	23.1	12.7	8.1	
16	21.9	12.1	7.7	4.7
18	21.0	11.6	7.5	4.6
24	18.5	10.6	6.8	4.3
32	13.1	9.7	6.3	4.0
40	9.3	8.8	5.9	3.7
50	6.2	6.8	5.5	3.5
60		4.7	5.0	3.3
65			4.2	3.3
70				3.2

Main boom 53 m

Radius (m)	Fixed jib length in (m)			
	11 t	20 t	26 t	32 t
6.7	24.0			
11	22.5	12.3		
13	21.7	11.9	7.6	
16	20.5	11.3	7.4	4.7
24	17.1	10.0	6.5	4.3
32	12.7	9.3	6.1	4.0
40	8.9	8.2	5.8	3.7
48	6.3	6.9	5.5	3.5
55	4.7	5.2	5.1	3.4
65		3.5	3.8	3.3
70			3.1	3.2
75				2.7

Main boom 59 m

Radius (m)	Fixed jib length in (m)			
	11 t	17 t	26 t	32 t
6.9	22.4			
10	21.4	14.5		
14	19.9	13.7	7.4	
16	19.0	13.3	7.2	4.6
18	18.2	12.9	6.9	4.5
24	15.5	11.9	6.4	4.2
32	12.0	11.1	6.0	4.0
40	8.5	8.8	5.7	3.7
48	6.0	6.4	5.5	3.5
60	3.5	3.9	4.3	3.4
70		2.4	2.8	3.0
75			2.2	2.4

Main boom 65 m

Radius (m)	Fixed jib length in (m)			
	11 t	20 t	26 t	32 t
7.2	20.3			
11	19.2	11.0		
14	18.0	10.6	7.1	
16	17.2	10.3	7.0	4.5
18	16.4	10.0	6.8	4.4
24	14.1	9.2	6.3	4.2
32	11.2	8.5	5.9	3.9
40	8.2	7.6	5.6	3.7
48	5.7	6.3	5.2	3.5
65	2.4	2.9	3.2	3.1
70		2.2	2.5	2.7
75				2.1

Main boom 68 m

Radius (m)	Fixed jib length in (m)			
	11 t	20 t	26 t	29 t
7.3	19.1			
11	18.0	10.6		
14	16.8	10.3	7.0	
15	16.6	10.1	6.9	5.6
16	16.1	10.0	6.8	5.6
18	15.2	9.7	6.6	5.5
24	13.2	8.9	6.2	5.1
32	10.7	8.2	5.8	4.8
40	7.9	7.4	5.5	4.6
48	5.5	6.0	5.1	4.4
65	2.3	2.8	3.1	3.2
70		2.1	2.4	2.5

Main boom 71 m

Radius (m)	Fixed jib length in (m)		
	11 t	14 t	17 t
7.4	17.7		
9	17.4	14.8	
10	17.1	14.7	12.4
12	16.4	14.3	12.2
14	15.6	13.7	11.9
16	15.0	13.2	11.5
18	14.2	12.7	11.2
24	12.3	11.2	10.1
32	10.2	9.6	9.0
40	7.6	7.7	7.7
48	5.3	5.5	5.6
65	2.1	2.3	2.5

Capacities in metric tonnes with fixed jib (No. 0806.xx), 52.3 t counterweight + 20 t carbody counterweight. Above lift chart is for reference only. For actual lift duty and complete chart with all available configurations please refer to lift chart in operator's cab or manual.

Lift chart - fixed jib (No. 0806.xx)

Offset 30°

TLT 10576238 M188886 Offiziell

Main boom 17 m

Radius (m)	Fixed jib length in (m)			
	11	20	26	32
8	24.0			
14	21.0	11.5		
18	18.0	10.2	6.7	
22	15.7	9.0	6.2	4.0
24	14.9	8.6	6.0	3.9
26	14.4	8.2	5.8	3.8
28	13.9	8.0	5.7	3.8
32		7.5	5.4	3.6
36		7.2	5.3	3.5
40			5.2	3.5
42			5.1	3.4
48				3.3

Main boom 26 m

Radius (m)	Fixed jib length in (m)			
	11	20	26	32
8.3	24.0			
14	21.6	11.7		
18	19.9	10.7	6.8	
22	17.7	9.7	6.4	4.0
24	16.8	9.3	6.2	3.9
26	16.1	9.0	6.0	3.8
28	15.4	8.7	5.9	3.8
32	14.1	8.1	5.7	3.7
36	11.8	7.7	5.5	3.6
44		7.3	5.3	3.4
50			5.2	3.4
55				3.3

Main boom 35 m

Radius (m)	Fixed jib length in (m)			
	11	20	26	32
8.6	23.4			
15	21.0	10.9		
18	20.1	10.3	6.6	
22	19.3	9.7	6.2	4.0
26	17.5	9.1	5.9	3.9
30	15.1	8.6	5.7	3.7
34	12.6	8.1	5.6	3.6
38	10.7	7.8	5.5	3.6
42	9.1	7.5	5.4	3.5
50		7.1	5.2	3.4
55			5.1	3.3
60				3.3

Main boom 44 m

Radius (m)	Fixed jib length in (m)			
	11	20	26	32
8.9	22.1			
15	20.4	10.9		
19	19.3	10.2	6.5	
24	18.0	9.6	6.1	3.9
28	15.9	9.1	5.9	3.8
32	13.4	8.8	5.8	3.7
36	11.2	8.4	5.6	3.6
44	8.0	7.7	5.4	3.5
50	6.3	7.0	5.3	3.4
60		4.8	5.1	3.3
65			4.2	3.3
70				3.2

Main boom 53 m

Radius (m)	Fixed jib length in (m)			
	11	20	26	32
9.3	20.6			
15	19.3	10.1		
19	18.1	9.6	6.2	
24	16.3	9.1	5.9	3.8
28	15.0	8.8	5.7	3.7
32	12.9	8.5	5.6	3.7
36	10.8	8.4	5.5	3.6
44	7.7	7.5	5.3	3.5
55	4.8	5.4	5.0	3.4
65		3.6	4.0	3.3
70			3.2	3.3
80				2.2

Main boom 59 m

Radius (m)	Fixed jib length in (m)			
	11	20	26	32
9.5	19.3			
16	17.8	9.6		
19	16.5	9.3	6.0	
24	14.8	8.8	5.8	3.8
28	13.4	8.6	5.6	3.7
32	12.1	8.3	5.5	3.6
36	10.4	8.0	5.4	3.6
44	7.4	7.2	5.3	3.4
55	4.5	5.2	5.1	3.3
60	3.6	4.2	4.6	3.3
70		2.6	3.0	3.3
75			2.3	2.6

Main boom 65 m

Radius (m)	Fixed jib length in (m)			
	11	20	26	32
7.2	20.3			
11	19.2	11.0		
14	18.0	10.6	7.1	
16	17.2	10.3	7.0	4.5
19	16.1	9.9	6.7	4.4
26	13.3	9.0	6.1	4.1
34	10.4	8.4	5.8	3.9
42	7.5	7.3	5.5	3.7
50	5.2	5.8	5.1	3.5
65	2.4	2.9	3.2	3.1
70		2.2	2.5	2.7
75				2.1

Main boom 68 m

Radius (m)	Fixed jib length in (m)			
	11	20	26	29
7.3	19.1			
11	18.0	10.6		
14	16.8	10.3	7.0	
15	16.6	10.1	6.9	5.6
16	16.1	10.0	6.8	5.6
20	14.5	9.4	6.4	5.3
28	11.8	8.6	5.9	4.9
36	9.2	7.9	5.6	4.7
44	6.6	6.7	5.3	4.5
55	3.9	4.5	4.7	4.3
65	2.3	2.8	3.1	3.2
70		2.1	2.4	2.5

Main boom 71 m

Radius (m)	Fixed jib length in (m)			
	11	14	17	
9.9	15.4			
12	15.0	12.9		
14	14.5	12.6	10.8	
16	13.8	12.3	10.7	
18	13.3	11.8	10.4	
20	12.7	11.4	10.1	
24	11.6	10.5	9.5	
28	10.7	9.9	9.0	
36	9.1	8.7	8.1	
44	6.6	6.9	6.9	
55	4.0	4.2	4.4	
65	2.2	2.4	2.6	

Capacities in metric tonnes with fixed jib (No. 0806.xx), 52.3 t counterweight + 20 t carbody counterweight. Above lift chart is for reference only. For actual lift duty and complete chart with all available configurations please refer to lift chart in operator's cab or manual.