

EN-US

HS 8070.1

HS 8003.02.03
www.liebherr.com

LIEBHERR

Construction machines



Concept and characteristics

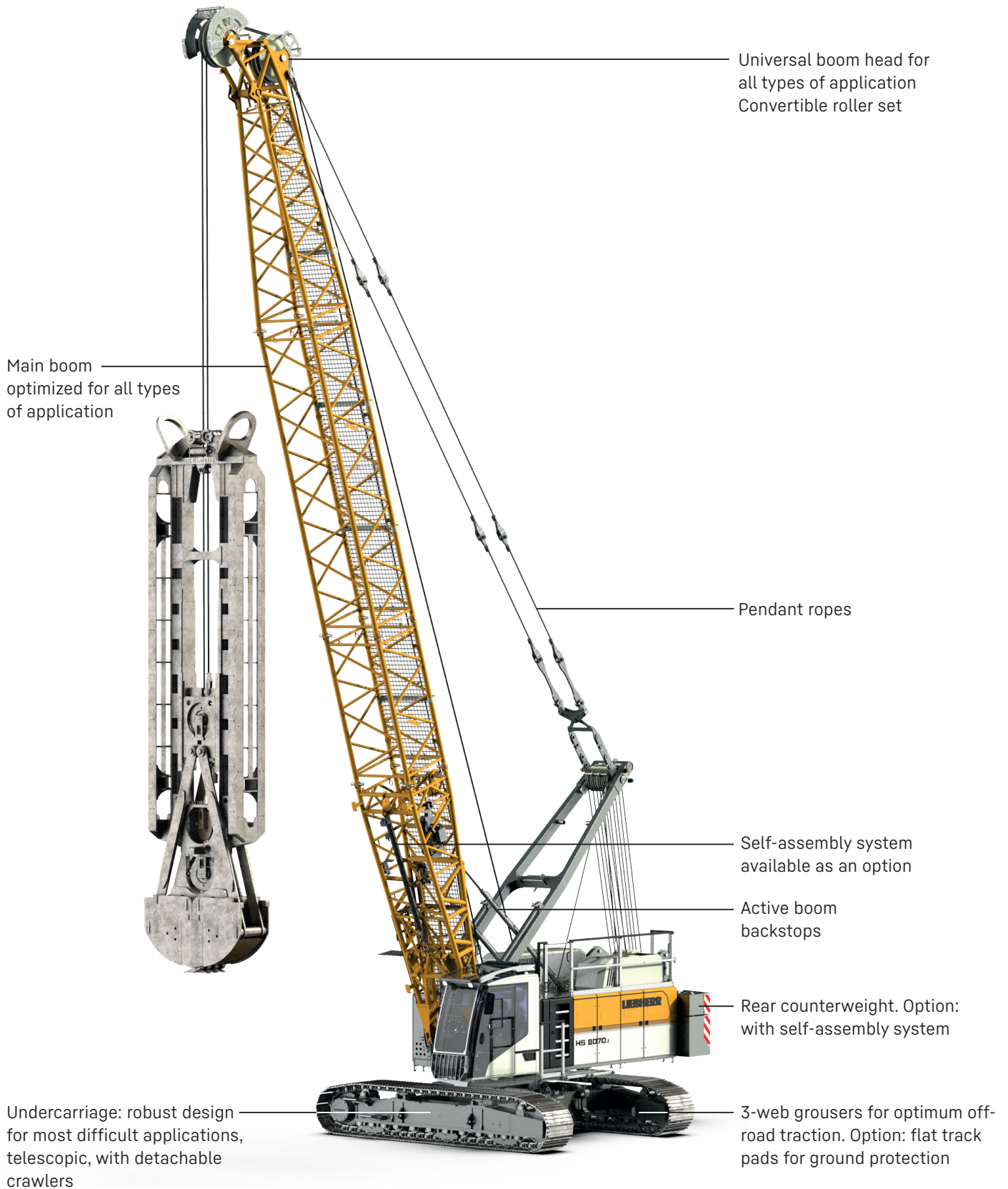



The newly developed cabin combines operator comfort with easy handling.

Air conditioning combined with an air-suspended seat offers an ideal workplace for the operator.

- Completely new cabin design focusing on ergonomics and operating comfort
- Improved soundproofing
- Orthopaedic seat, heatable, coolable and ventilated
- Individually adjustable monitors
- Integrated cool box for storage of provisions
- Charger for mobile devices
- Front window made of safety glass
- Heated outside mirror
- Option: Piling control incl. cabin protection and armoured glass

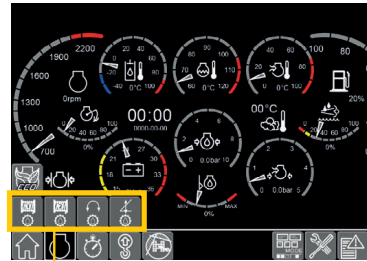

Gear oil level warning

The new warning allows the operator to check the gear oil levels of both main winches, the swing drive and the luffing winch. This facilitates daily maintenance of the machine.

Example



Gear oil level warning of winch 1 lights up green: Gear oil level of winch 1 is sufficient.



Gear oil level warning of winch 1 lights up yellow after ten seconds: fill gear oil for winch 1.



Ground Pressure Visualization



Technical description



Operating weight

Composition of operating weight	The operating weight includes the basic machine with undercarriage, 2 main winches 44,962 lbf including wire ropes (295 ft), and 36 ft main boom, consisting of A-frame, boom foot (18 ft) and boom head (18 ft), 44,754 lbs rear counterweight, 2.6 ft 3-web grousers and 132,277 lbs hook block
Total weight	approx. 160,000 lbs

Ground pressure

Ground pressure	14.2 PSI	with 2.3 ft grousers
	12.8 PSI	with 2.6 ft grousers
	11.5 PSI	with 3 ft grousers

Equipment

Main boom (1311.24)	max. 164 ft in lifting operation max. 105 ft in duty cycle operation
Characteristics	modular designed equipment for lifting, dragline or clamshell operation for dragline operation, a rotating fairlead is fitted into the boom foot minimized rope angle to drum resulting in lower rope wear

Diesel engine

Power rating according to ISO 9249	320 kW (429 hp) at 1700 rpm
Engine type	Liebherr D 936 A7-05
Fuel tank capacity	125 gal with continuous level indicator and reserve warning
AdBlue tank capacity	12 gal with continuous level indicator and reserve warning
Exhaust certification	97/68 EC Stage IV; EPA/CARB Tier 4f 97/68 EC Stage V; EPA/CARB Tier 4f ECE-R.96 Power Band H non-certified emission standard

Noise measurement data and vibration

Noise emission	according to 2000/14/EC directive	
Emission sound pressure level L_{PA}	74 dB(A)	(in the cabin)
Guaranteed sound power level L_{WA}	107 dB(A)	(of the machine)
Vibration transmitted to the machine operator	< 8.2 ft/s ²	(to the hand-arm system)
	< 1.6 ft/s ²	(to the whole body)

Hydraulic system

Hydraulic pumps	Variable pumps in closed and open circuits supplying oil only when needed (flow control on demand)	
Hydraulic oil tank capacity	217 gal	
Max. working pressure	5,076 PSI	
Max. power at the connection plate	268 hp (2x 77 gal/min) for external appliances	
Hydraulic oil	electronic monitoring of all filters use of synthetic environmentally friendly oil possible	
Hydraulic retrofit kits for attachments	ready-made customized hydraulic retrofit kits are available e.g. powering casing oscillators, vibrators, hydraulic grabs, fixed leaders	

Hoisting gear

Main winches	pressure controlled, variable flow hydraulic motors for the drag and hoist winches, full utilisation of engine power as the winch speed is automatically adjusted to suit the respective line pull Free fall: clutch and braking functions are provided by the service brake (low wear and maintenance-free multi-disc brake in compact design)	
Winch options	Standard	Option
Line pull in the 1st layer	44,962 lbf	35,969 lbf
Rope diameter	30mm	26mm
Drum diameter	2.1ft	1.8ft
Rope speed	0-410 ft/min	0-427 ft/min
Rope capacity in the 1st layer	133 ft*	136 ft*
Rope capacity in the 3rd layer	490 ft*	479 ft*
	*effective length	
Options		
Auxiliary winch	15,737 lbf in boom foot	
Tagline winch	6,744 lbf with free fall	

Boom winch

Line pull	max. 23,605 lbf
Rope diameter	20 mm
Boom luffing	15-86° in 44 s

Crawlers

Drive system	with fixed axial piston hydraulic motors
Crawler side frames	maintenance-free, with hydraulic chain tensioning device
Brake	hydraulically released, spring-loaded multi-disc holding brake
Drive speed	0-0.9 mph
Grousers	3-web grousers, width 2.6 ft
Width of undercarriage	automatic track width adjustment from transport width to operating width via hydraulic cylinders
Options	self-assembly system, jack-up system 3-web grousers, width 3 ft 3-web grousers, width 2.3 ft track pads, width 2.6 ft Crawler overdrive: 0-1.6 mph

Swing gear

Drive system	2x swing drives (standard) with fixed axial piston hydraulic motors, planetary gearbox, pinion
Swing ring	roller bearing with external teeth
Brake	hydraulically released, spring-loaded multi-disc holding brake
Swing speed	0-4.5 rpm continuously variable, selector for 3 speed ranges to increase swing precision
Lubrication system	reduces maintenance requirements and increases service life
Option	Display of swing angle swing ring protection automatic central lubrication system for bearings and teeth

Control

Control	includes all control and monitoring functions, designed to withstand extreme environmental conditions and heavy duty construction tasks
Display	high resolution monitor in the operator's cabin, clear display of complete machine operating data, warnings and failure indications in the required language
Operation	several movements can be performed simultaneously thanks to electro-hydraulic proportional control, all categories of loads can be positioned with utmost precision
Options	PDE*: process data recording LiTU: Liebherr Telematics Unit

Dimensions

Basic machine with undercarriage, crawlers detachable

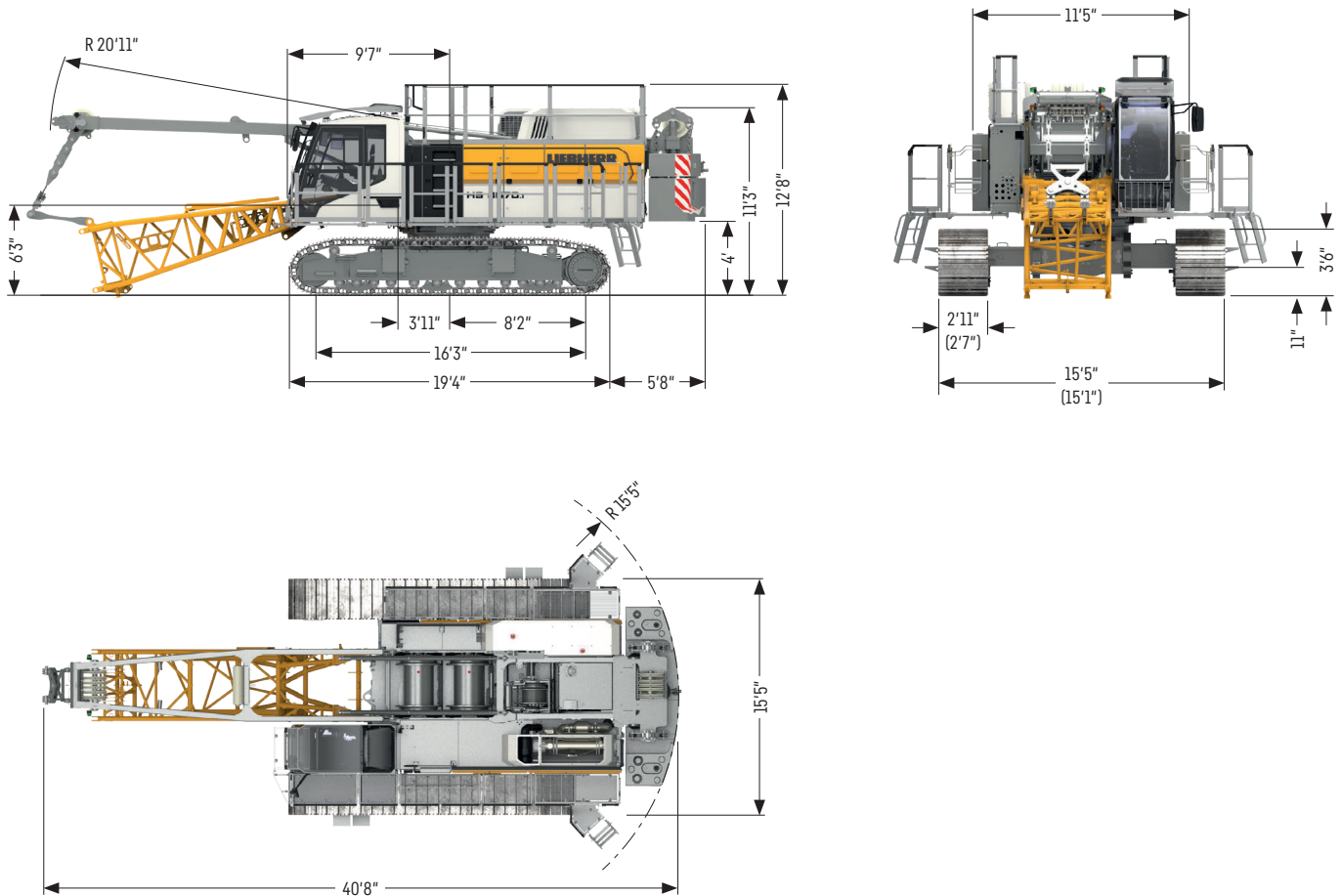

Remarks

- Liebherr cable excavator HS 8003.02.03
- Designed according to EN 474-1 and EN 474-12.
Designed and tested in accordance to ASME B 30.5
- Machine standing on firm, horizontal ground.
- The weight of the lifting device (pulley block, hoist ropes, shackles etc.) must be deducted from the load capacity.
- Additional equipment on boom (e.g. walkways) must be deducted from the lifting capacity.
- For max. wind speed please refer to lift chart in operator's cab or manual.
- Working radii are measured from centre of swing and under load.
- The lifting capacities are valid for 360 degrees of swing.
- Weights may vary depending on the delivered configuration of the machine filling level of the tanks as well as generally valid tolerances.
- The figures in this brochure may include options which are not within the standard scope of supply of the machine.

Basic machine with undercarriage, crawlers non-detachable

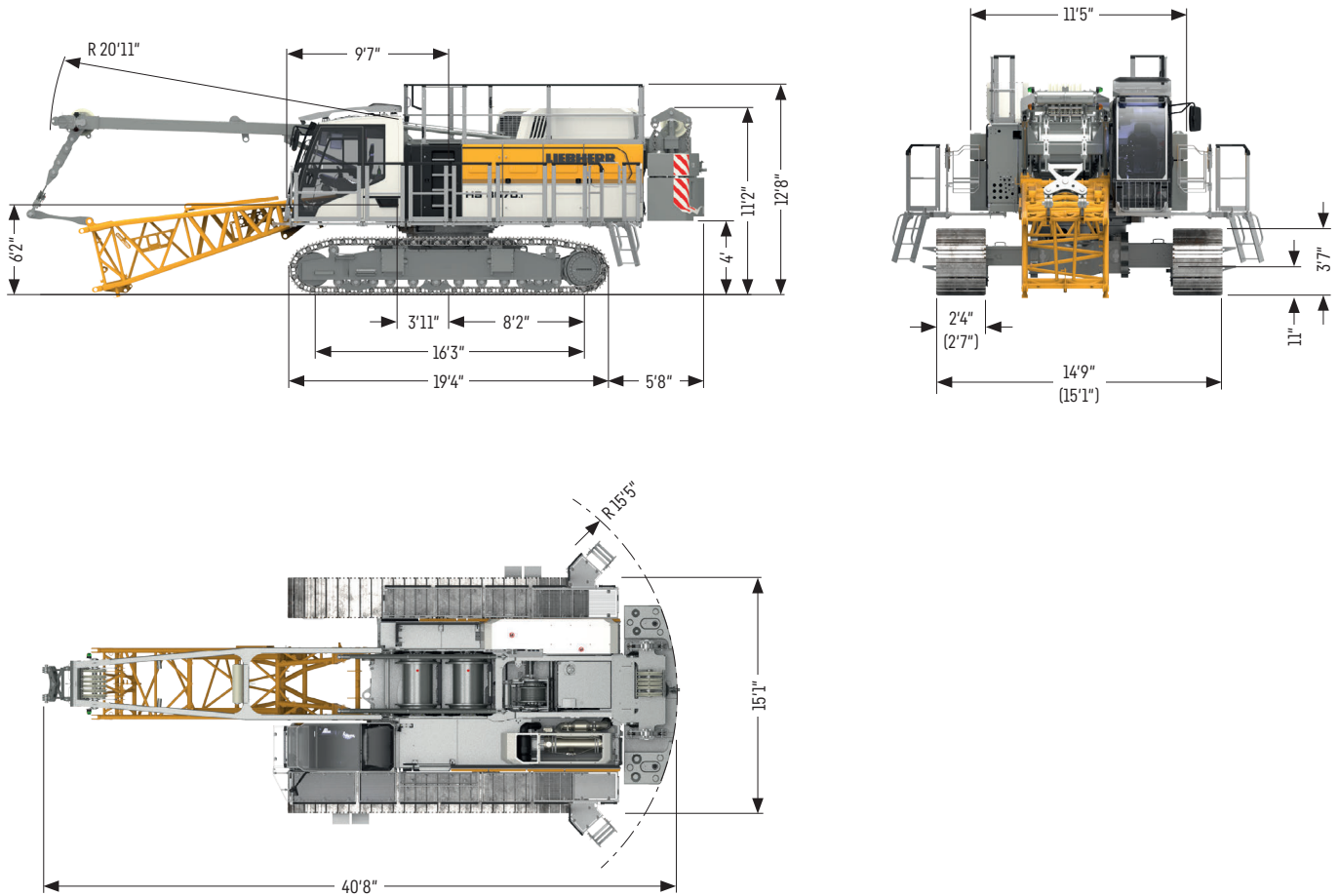

Grab versions



Dredging assistant (option)



Further information on material handling



Casing oscillator

Max. drilling diameter

ft 6.6

Capacities in grab operation

Capacities in [1000 lbs] with 44,754 lbs counterweight

Radius [ft]	Boom length [ft]							
	36	46	56	66	76	85	95	105
20	66.7	66.7	66.7	66.7	66.7	66.7	66.7	66.7
25	57.2	57.5	57.5	57.5	57.4	57.4	57.2	56.6
30	44.0	44.2	44.3	44.2	44.1	44.0	43.9	43.7
35	35.3	35.6	35.7	35.6	35.5	35.4	35.2	35.0
40	29.1	29.5	29.6	29.5	29.4	29.3	29.1	28.9
45	13.4	25.0	25.1	25.0	24.9	24.8	24.6	24.4
50	11.7	21.3	21.6	21.6	21.5	21.3	21.1	20.9
55			18.8	18.8	18.7	18.5	18.3	18.1
60				16.5	16.4	16.3	16.1	15.9
65				14.6	14.6	14.4	14.2	14
70					12.9	12.8	12.6	12.4
75					11.5	11.4	11.3	11.1
80						10.2	10.1	9.9
85						9.2	9.1	8.8
90							8.1	7.9
95							7.3	7.1
100								6.4
105								5.7

TLT 13164865 274756 - v2. Stability calculated according to EN 474-12. Max. capacities do not exceed 66% of tipping load.

Slurry wall grab

Maximum capacity in duty cycle operation with standard ropes

Line pull (1 st layer)	lbf 44,962
Rope diameter	mm 30
Minimum breaking load	lbf 190,190
Line pull - 1-rope duty cycle operation	lbf 44,962
Line pull - 2-rope duty cycle operation ¹⁾	lbf 68,120

1) Lifting a load exceeding the line pull of one winch is only allowed if it can be ensured that each individual winch is not overloaded.
 When working with a mechanical 2-rope grab the total load to be lifted is limited by the line pull of one winch.
 Rigging and ropes are part of the load.
 Capacities in slurry wall operation are for reference only and are not programmed in the LML system.

All loads and counterweight configurations are max. values and must not be exceeded.
 Weight of additional equipment on boom (e.g. walkways, hose drums etc.) must be deducted to get the net capacity.



Load chart for slurry wall operation

Capacities in [1000 lbs] with 44,754 lbs counterweight

Radius [ft]	Boom length [ft]							
	36	46	56	66	76	85	95	105
20					65.7	67.1	61.4	64.5
25		51.6	51.6	51.6	51.7	51.2	51.5	51.0
30	39.0	39.1	39.1	39.1	39.0	38.8	38.6	38.6
35	31.1	31.2	31.3	31.2	31.0	30.9	30.6	30.5
40		25.6	25.7	25.5	25.4	25.2	25.0	24.7
45		21.5	21.6	21.4	21.3	21.0	20.9	20.6
50			18.3	18.2	18.1	17.8	17.6	17.4
55			10.6	15.7	15.5	15.3	15.1	14.8
60			15.8	13.6	13.5	13.2	13.0	12.7
65				11.8	11.7	11.5	11.3	11.0
70					10.3	10.0	9.8	9.5
75					9.0	8.8	8.6	8.3
80						7.7	7.5	7.2
85						6.7	6.5	6.2
90							5.7	5.4
95							4.9	4.6
100								4.0

Preliminary. Stability calculated according to EN 16228-5. Max. lifting capacity with mechanical grab is 44,092 lbs.
 For higher lifting capacities a hydraulic grab is required.



For further information please refer to the HSG 5-18 datasheet

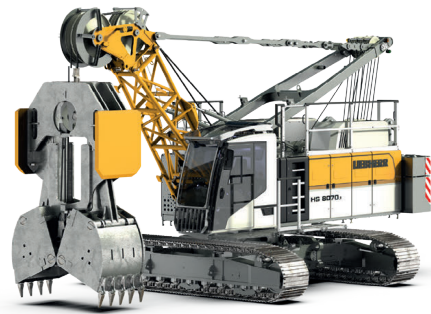

Short boom

Data available on request

Dynamic soil compaction



Capacities in [1000 lbs] with 44,754 lbs counterweight

Radius [ft]	Boom length [ft]		
	66	75	85
26	38.7	38.0	37.3
30	31.2	30.5	29.6

TLT 13164865 M253330 - v2. Max. capacities in metric tonnes do not exceed 75 % of tipping load.

All loads given are max. values and must not be exceeded. They are only permitted in two-rope automatic operation and are valid for work on a surface with max. inclination of 1%.

Lifting heights must not exceed 82 ft.

Option: Piling control incl. cabin protection and armoured glass

Max. main boom 85 ft

Special applications

- Vibro-flot (deep vibrator)
- Hammer
- Vibrator (free-hanging)
- Shaft excavation
- Rock handling
- Magnet system
- Demolition (longer main booms available on request)

Capacities in [1000 lbs] with 44.754 lbs counterweight

Radius [ft]	Boom length [ft]							
	36	46	56	66	76	85	95	105
20	66.7	66.7	66.7	66.7	66.7	66.7	66.7	66.7
25	65.1	65.3	65.4	65.4	63.0	63	58.6	56.6
30	50.0	50.3	50.3	50.3	50.2	50.2	47.8	46.2
35	40.2	40.5	40.6	40.5	40.3	40.3	40.0	38.7
40	33.1	33.5	33.7	33.6	33.5	33.5	33.1	32.9
45		28.4	28.5	28.5	28.3	28.3	27.9	27.7
50		24.2	24.6	24.5	24.4	24.4	24.0	23.8
55			21.4	21.3	21.2	21.2	20.8	20.6
60				18.7	18.7	18.7	18.3	18.0
65				16.6	16.5	16.5	16.2	15.9
70					14.7	14.7	14.4	14.1
75					13.1	13.1	12.8	12.6
80							11.5	11.2
85							10.3	10.0
90							9.2	9.0
95							8.3	8.0
100								7.1
105								6.3

TLT 13164865 274756. Stability calculated according to EN 474-12. Max. capacities do not exceed 75% of tipping load.
Max. main boom 105 ft

Dragline equipment

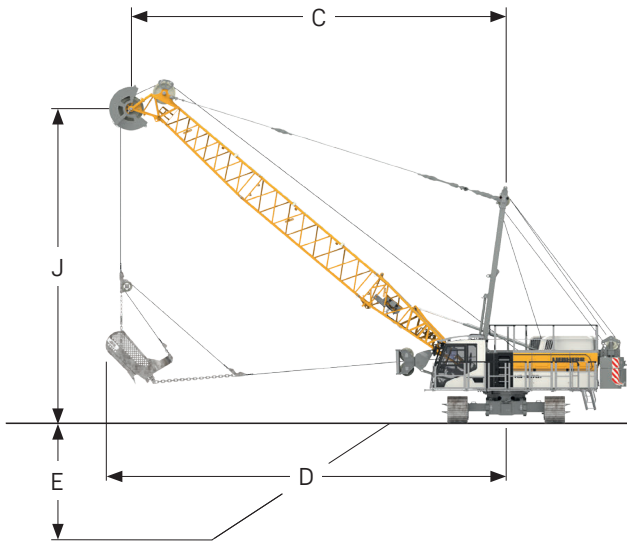

Digging diagram

C = Radius / dumping radius

D = Max. digging radius = approx. $C + 1/3$ to $1/2 J$

E* = Digging depth = approx. 40 - 50 % of C

J = Height to centre rope pulley boom head

*The depth of cut, casting distance and digging reach may vary considerably depending on digging conditions, design of bucket and operator's skill. Maximum digging depths are attainable under ideal conditions and cannot be guaranteed.

Capacities in dragline operation

Capacities in [1000 lbs] with 44,754 lbs counterweight

alpha [°]	Boom length [ft]								
	46			56			66		
	C [ft]	J [ft]	Rear counterweight [x 1000 lbs]	C [ft]	J [ft]	Rear counterweight [x 1000 lbs]	C [ft]	J [ft]	Rear counterweight [x 1000 lbs]
55	33.3	43.8	41.7	39.0	51.9	35.1	44.6	59.9	28.9
50	36.4	41.4	38.6	42.7	48.9	30.9	49.0	56.4	25.3
45	39.2	38.7	34.6	46.1	45.6	27.6	53.1	52.6	22.5
40	41.7	35.7	31.8	49.3	42.0	25.1	56.8	48.4	20.4
35	44.0	32.5	29.4	52.0	38.2	23.3	60.2	43.8	18.6
30	45.9	29.1	27.7	54.6	34.1	21.7	63.0	39.0	17.4
25		25.6			N.A.			N.A.	

TLT 13164865 274756

Capacities in [1000 lbs] with 44,754 lbs counterweight

alpha [°]	Boom length [ft]								
	76			85			95		
	C [ft]	J [ft]	Rear counterweight [x 1000 lbs]	C [ft]	J [ft]	Rear counterweight [x 1000 lbs]	C [ft]	J [ft]	Rear counterweight [x 1000 lbs]
55	50.3	68.0	24.2	55.9	76.1	20.5	61.6	84.1	17.6
50	55.4	64.0	21.0	61.7	71.5	17.8	68.0	79.1	15.1
45	60.2	59.5	18.6	67.0	66.5	15.6	74.0	73.5	13.1
40	64.4	54.7	16.8	71.9	61.0	13.9	79.5	67.3	11.6
35	68.2	49.5	15.3	76.3	55.1	12.6	84.4	60.8	10.4
30	71.5	43.9	14.2	80.2	48.8	11.6	88.7	53.8	9.5
25		38.1			42.2			46.4	

TLT 13164865 274756 Stability calculated according to EN 474-12. Max. capacities do not exceed 75% of tipping load.

The size of the bucket has to be determined according to local conditions.

Max. main boom 105 ft

Planning aid for dragline operation

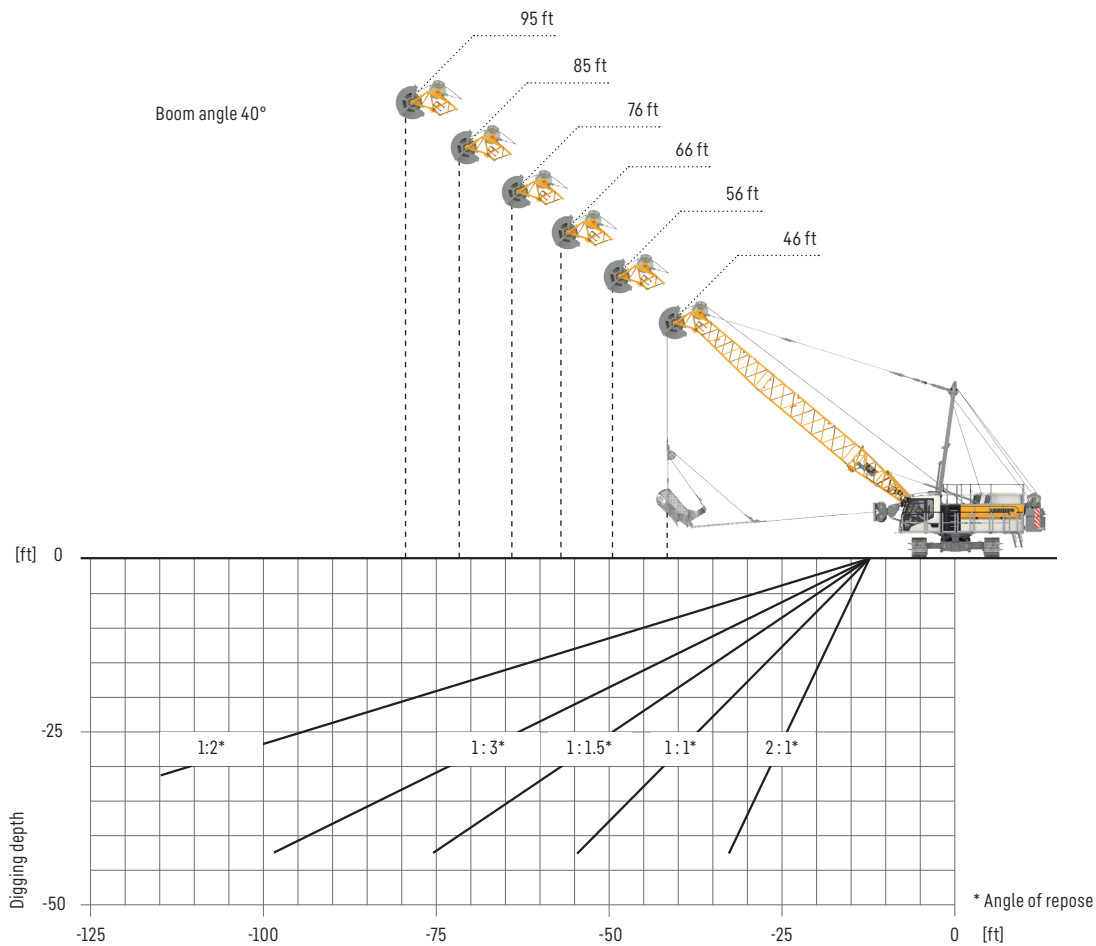

Selection of dragline bucket and possible digging depths at 40° boom angle

Main boom [ft]	46	56	66	76	85	95
Dragline bucket [m³/ yd³]	5 / 6.5	3.8 / 5	3.5 / 4.5	2.7 / 3.5	2.1 / 2.75	1.7 / 2.25

Density: 1.8 tm³ and fill factor 0.8

* The digging depth depends on the material's angle of repose.

Lifting operation

Main boom 84°-15°

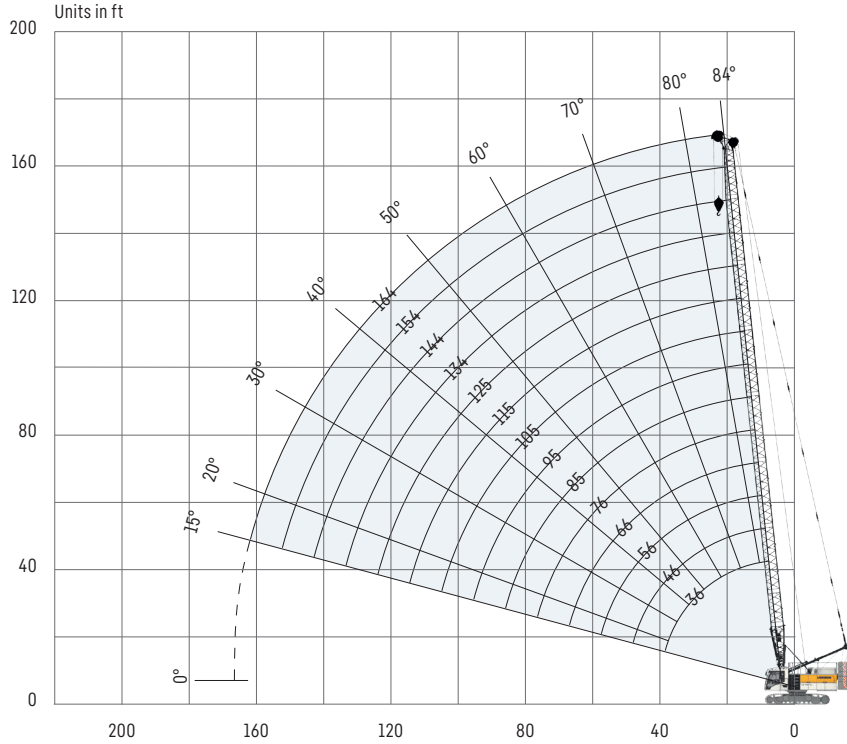









Auxiliary jib 44,092 lbs
 The maximum capacity of the auxiliary jib is 44,092 lbs.
 The corresponding load chart is programmed in the LML system.

Main boom configuration

Boom section	Amount of boom sections													
Boom foot 18 ft	1	1	1	1	1	1	1	1	1	1	1	1	1	1
Boom section 10 ft		1		1		1		1		1		1		1
Boom section 20 ft			1	1	2	2	3	3	4	4	5	5	6	6
Boom head 18 ftm	1	1	1	1	1	1	1	1	1	1	1	1	1	1
Boom length [ft]	36	46	56	66	76	85	95	105	115	125	134	144	154	164
Auxiliary jib	✓	✓	✓	✓	✓	✓	✓	✓	✓	✓	✓	✓	✓	✓

preferred boom combinations

Capacities in [1000 lbs]

	Boom length [ft]															
	36				46				56				66			
*	38.1	44.8	51.4 	64.6 	38.1	44.8	51.4 	64.6 	38.1	44.8	51.4 	64.6 	38.1	44.8	51.4 	64.6 
10			154.3**													
15	125.7		154.3**		121.7		154.3		114.7		151.6		108.4		143.4	
20	88.5		117.2		84.6		112.3		80.9		107.5		77.4	84.4	103.0	
25	62.9	68.6	83.9		63.2	68.9	84.1		61.9	67.5	82.7	93.9	59.6	65.1	79.8	90.6
30	48.2	52.6	64.6	73.6	48.4	52.9	64.9	73.9	48.5	53.0	65.0	73.9	48.0	52.5	64.7	73.7
35	38.5	42.2	52.0	59.4	38.8	42.5	52.4	59.8	38.9	42.6	52.5	59.8	38.8	42.5	52.3	59.7
40	31.8	32.2	32.2	32.2	32.2	35.1	43.5	49.8	32.2	35.3	43.7	49.9	32.2	35.1	43.5	49.8
45					27.1	29.9	36.9	42.4	27.3	30	37.1	42.6	27.2	29.9	37.0	42.5
50					23.0	25.5	31.9	32.2	23.4	25.8	32.2	36.9	23.3	25.7	32.2	36.8
55									20.2	22.4	28.2	32.3	20.2	22.3	28.1	32.3
60													17.6	19.6	24.8	28.7
65													15.4	17.2	22.0	25.6

TLT 13164863 286145

- * Rear counterweight in [1000 lbs]
-  + 33,700 lbs carbody counterweight
- ** Max. capacity



www.liebherr.com/CranePlanner

 **Crane Planner 2.0**

Capacities in [1000 lbs]

		Boom length [ft]																	
		125				134				144				154				164	
* Radius [m]		38.1	44.8	51.4	64.6	38.1	44.8	51.4	64.6	38.1	44.8	51.4	64.6	44.8	51.4	64.6	51.4	64.6	
	10																		
15																			
20		60.2	65.9	81.0	92.2	57.3	62.8	77.4	88.2	52.4	57.5								
25		47.6	52.3	64.7	73.9	45.8	50.4	62.5	71.5	44.2	48.6	60.4	69.2	46.8	58.4	66.9	56.5	57.6	
30		38.9	42.8	53.4	61.2	37.5	41.4	51.7	59.3	36.2	40	50.1	57.5	38.5	48.5	55.8	46.9	53.7	
35		32.5	35.9	45.1	51.8	31.7	34.7	43.7	50.3	30.6	33.5	42.3	48.8	32.3	41.0	47.4	39.7	46.0	
40		27.9	30.9	38.7	44.7	26.9	29.8	37.5	43.4	25.9	28.8	36.4	42.1	27.8	35.2	40.9	34.1	39.7	
45		23.9	26.7	33.7	39.0	23.1	25.7	32.6	37.9	22.2	24.8	31.9	36.8	23.9	30.9	35.7	29.6	34.7	
50		20.8	23.2	29.8	34.4	20	22.4	28.9	33.4	19.2	21.6	28	32.5	20.8	27.1	31.5	25.9	30.5	
55		18.2	20.4	26.4	30.8	17.4	19.6	25.6	30.0	16.7	18.9	24.7	29.1	18.1	23.9	28.0	22.9	27.1	
60		16.0	18.0	23.3	27.3	15.3	17.3	22.8	26.8	14.6	16.6	22.0	26	15.9	21.2	25.2	20.2	24.1	
65		14.0	15.8	20.6	24.2	13.4	15.3	20.3	23.9	12.8	14.6	19.7	23.4	13.9	18.9	22.6	18.2	21.6	
70		12.2	13.9	18.3	21.6	11.8	13.5	18.0	21.3	11.2	12.9	17.6	21.0	12.2	16.9	20.4	16.2	19.5	
75		10.7	12.2	16.3	19.4	10.4	11.9	16.0	19.1	9.8	11.4	15.7	18.7	10.8	15.1	18.4	14.4	17.5	
80		9.4	10.8	14.6	17.5	9.0	10.5	14.3	17.2	8.6	10.1	14.0	16.8	9.5	13.6	16.5	12.9	15.8	
85		8.2	9.5	13.1	15.8	7.9	9.2	12.8	15.5	7.5	8.9	12.5	15.1	8.4	12.1	14.8	11.6	14.4	
90		7.2	8.4	11.8	14.3	6.9	8.1	11.5	14.0	6.5	7.8	11.1	13.7	7.4	10.8	13.3	10.4	13.0	
95		6.3	7.5	10.6	13	6.0	7.1	10.3	12.7	5.6	6.8	10.0	12.3	6.5	9.6	12.0	9.3	11.6	
100		5.4	6.6	9.6	11.8	5.1	6.3	9.3	11.5	4.8	5.9	8.9	11.2	5.6	8.6	10.8	8.2	10.5	
105		4.7	5.8	8.6	10.8		5.5	8.3	10.5		5.1	8.0	10.1	4.8	7.6	9.8	7.3	9.4	
110			5.1	7.8	9.8		4.8	7.5	9.5			7.1	9.2		6.8	8.8	6.4	8.5	
115				7.0	8.9			6.7	8.6			6.3	8.3		6.0	8.0	5.6	7.6	
120				6.2	8.1			6.0	7.8			5.6	7.5		5.3	7.2	4.9	6.8	
125				5.6	7.3			5.3	7.1			5.0	6.7		4.6	6.4		6.1	
130								4.7	6.4				6.1			5.7		5.4	
135									5.7				5.4			5.1		4.8	
140													4.8			4.5			

TLT 13164863 286145

* Rear counterweight in [1000 lbs]
 + 33,700 lbs carbody counterweight

Lifting operation

Lifting operation with fixed jib 15° (0806.20)

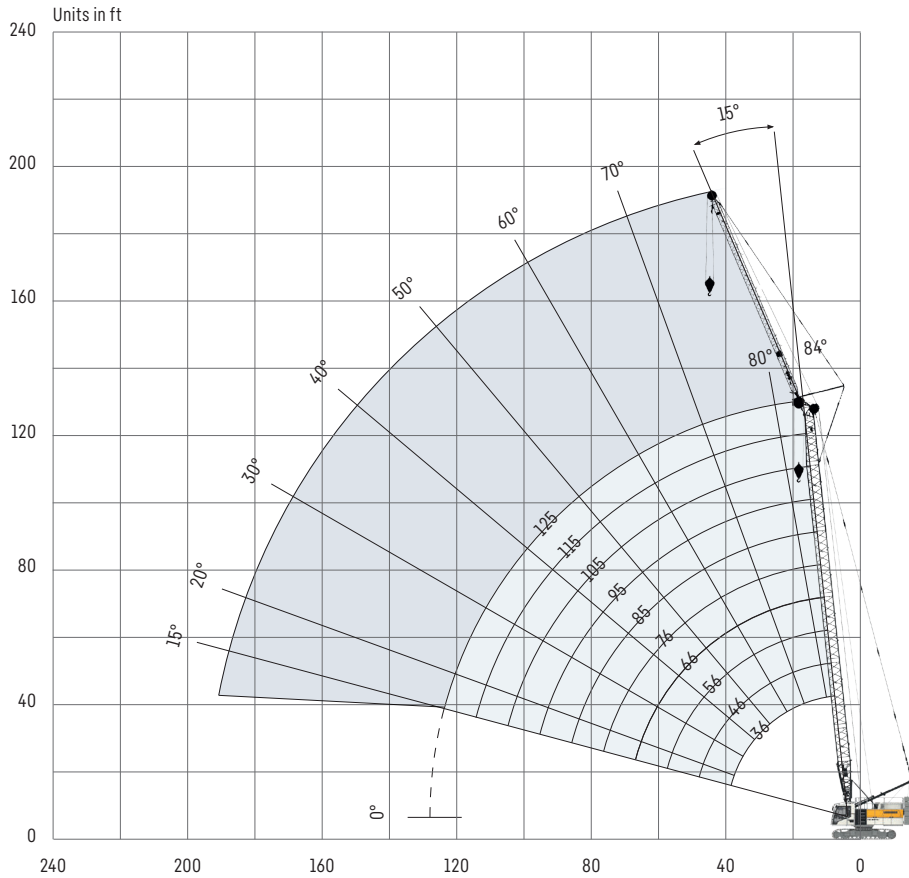

Jib configuration 0806HS

Boom section	Amount of boom sections	
Boom foot 18 ft	1	1
Jib section 30 ft		1
Boom head 18 ft	1	1
Boom length [ft]	36	66

For main boom configuration 66 - 105 ft please refer to the table on page 16.

Lifting operation with fixed jib 15° (0806.20)

Data available on request

Transport dimensions and weights

Basic machine and main boom (1311.24)

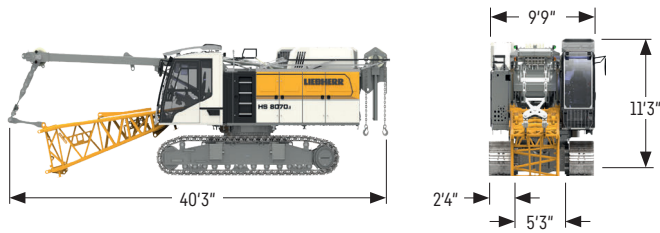

Basic machine, crawlers non-detachable

with HD undercarriage, boom foot (1311.24), A-frame, 2x 44,962 lbf winches, without rear counterweight

Width with 2.3 ft 3-web grousers	inch	118.1
Weight with 2.3 ft 3-web grousers	lbs	101,192
Width with 2.6 ft 3-web grousers	inch	133.9
Weight with 2.6 ft 3-web grousers	lbs	103,176
Width with 3 ft 3-web grousers	inch	137.8
Weight with 3 ft 3-web grousers	lbs	107,145
Weight of hoist ropes	lbs/ft	3.11

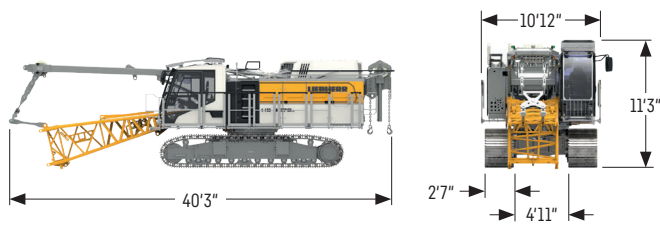

Basic machine, crawlers detachable

with HD undercarriage, boom foot (1311.24), A-frame, 2x 44,962 lbf winches, without rear counterweight

Width with 2.6 ft 3-web grousers	inch	133.9
Weight with 2.6 ft 3-web grousers	lbs	113,759
Width with 3 ft 3-web grousers	inch	137.8
Weight with 3 ft 3-web grousers	lbs	117,727
Weight of hoist ropes	lbs/ft	3.11

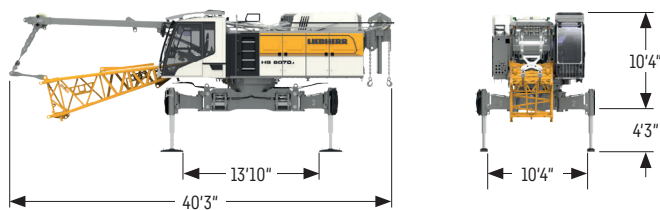

Basic machine, crawlers detachable

with HD undercarriage, without crawlers, incl. jack-up cylinder, boom foot (1311.24), A-frame, 2x 44,962 lbf winches, without rear counterweight

Width	inch	118.1
Weight	lbs	81,130
Weight of hoist ropes	lbs/ft	3.11

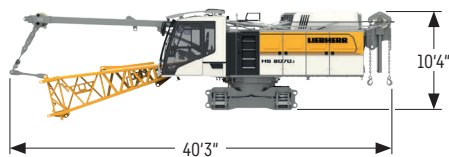

Basic machine, crawlers detachable

with HD undercarriage, without crawlers, with boom foot (1311.24), A-frame, 2x 44,962 lbf winches, without rear counterweight

Width	inch	118.1
Weight	lbs	75,619
Weight of hoist ropes	lbs/ft	3.11

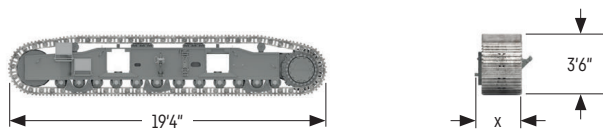

Crawler (2x)

Width with 2.6 ft 3-web grousers (dimension x)	inch	35.2
Width with 3 ft 3-web grousers (dimension x)	inch	37.2
Weight with 2.6 ft 3-web grousers	lbs	13,360
Weight with 3 ft 3-web grousers	lbs	17,262



Boom section 10 ft (1311.24)

Width	inch	56.3
Weight with 3 ft flat track pads	lbs	18,298
Weight incl. pendant ropes	lbs	1,157



Boom section 20 ft (1311.24)

Width	inch	56.3
Weight incl. pendant ropes	lbs	1,940

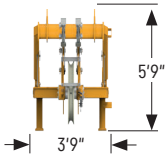
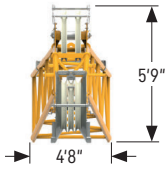

Boom head* (1311.24)

Width	inch	56.3
Weight incl. pendant ropes	lbs	4,674

*) Steel sheaves (2+3)

Auxiliary jib

Width	inch	44.7
Weight	lbs	2,392

Weights can vary with the final configuration of the machine. The figures in this brochure may include options which are not within the standard scope of supply of the machine.

Fixed jib

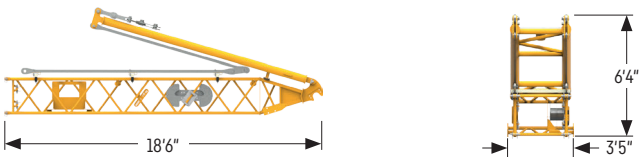
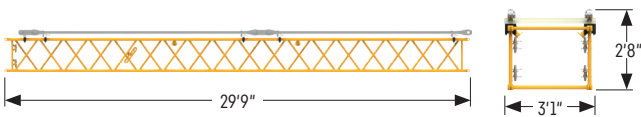
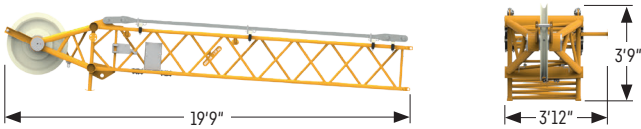

Jib head

Width	inch	47.8
Weight	lbs	1,676

Jib section 30 ft

Width	inch	36.6
Weight	lbs	1,488

Jib foot with A-frame

Width	inch	40.7
Weight	lbs	2,161

Counterweight

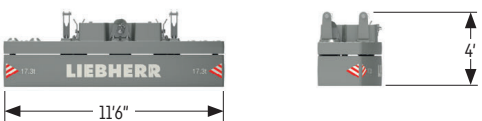

Counterweight slab (standard 2x, option 6x)

Width	inch	33.5
Weight	lbs	3,307

Counterweight slab (1x)

Width	inch	41.3
Weight	lbs	38,206

Carbody counterweight (option 2x)

Width	inch	64.6
Weight	lbs	16,535

Hooks

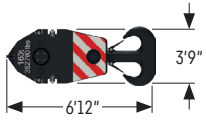

220,462 lbs hook block - 2 sheaves

Width	inch	15.1
Weight	lbs	2,646

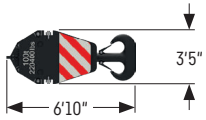

132,277 lbs hook block - 1 sheave

Width	inch	10.3
Weight	lbs	2,138

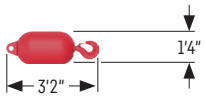

66,139 lbs hook block - 1 sheave

Width	inch	15.7
Weight	lbs	882

Self-assembly system



Unloading of basic machine (option)

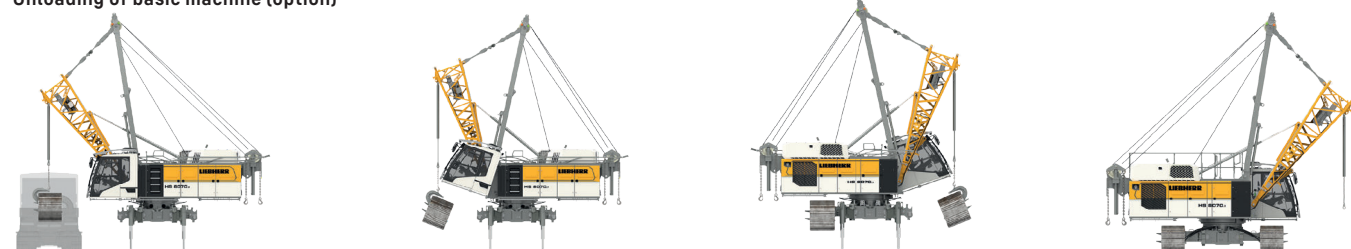

Unloading and assembly of crawlers



Unloading of basic machine (standard)

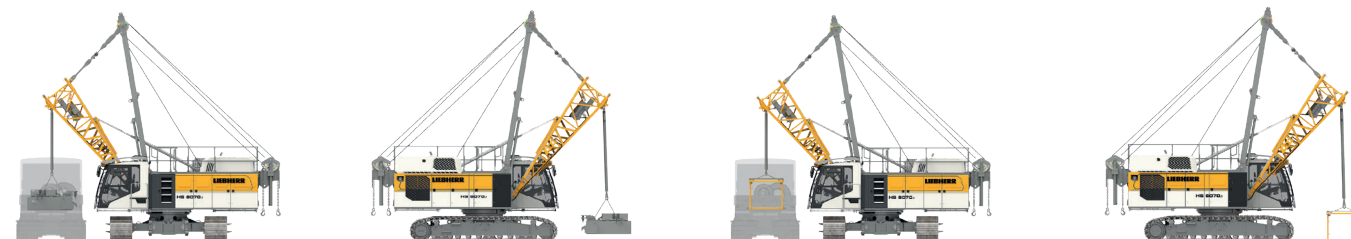

Unloading and assembly of carbony counterweight

Unloading and assembly of boom



Unloading and assembly of rear counterweight



Assembly of boom and reeving of hoist ropes

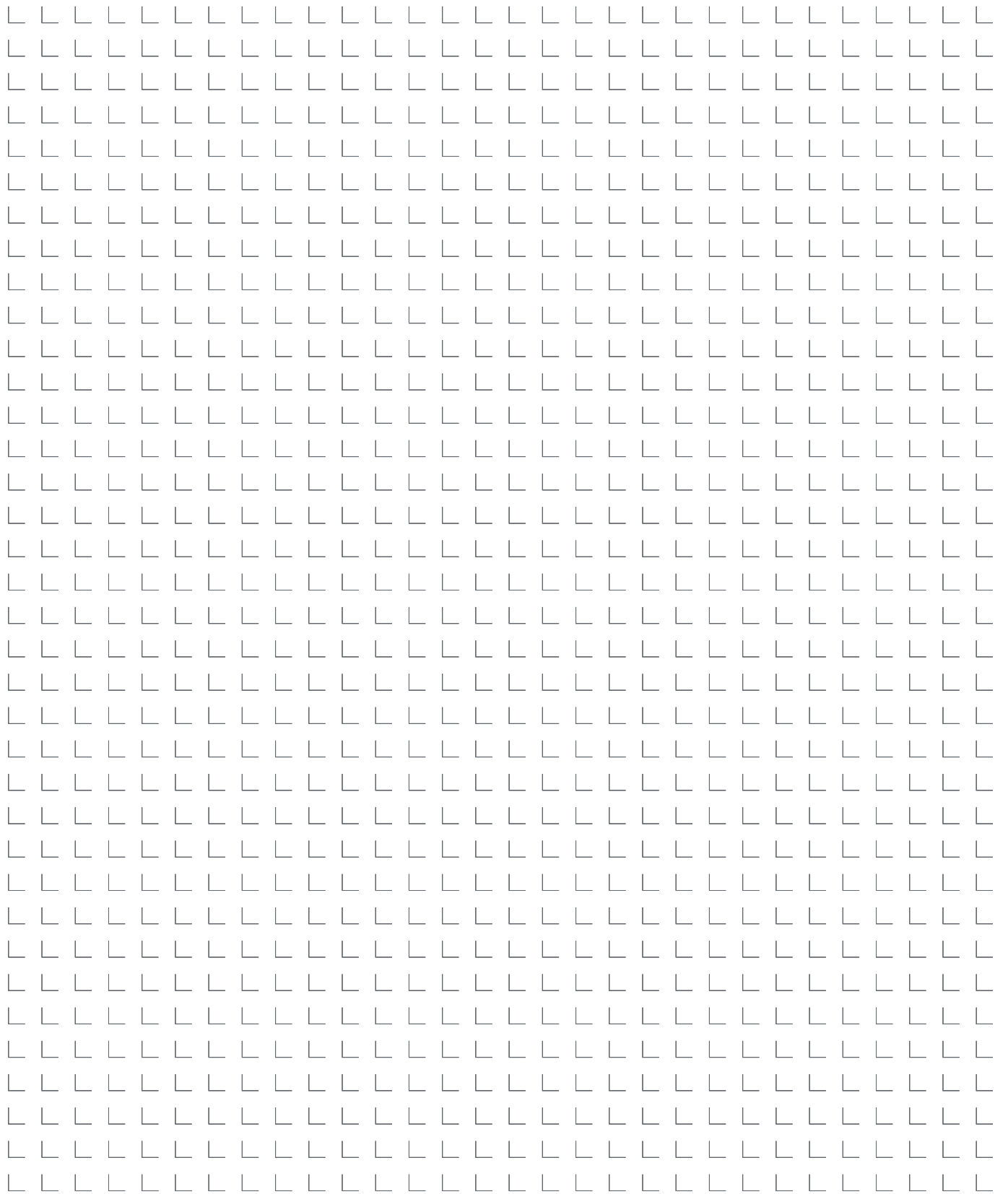

Liebherr-Werk Nenzing GmbH · Dr. Hans Liebherr Str. 1 · 6710 Nenzing, Austria
Phone +43 50809 41-473 · crawler.crane@liebherr.com · www.liebherr.com
facebook.com/LiebherrConstruction

Liebherr USA, Co. · 7075 Bennington Street · Houston, TX 77028-5812
Phone (713) 636-4050 · crawler.cranes.usa@liebherr.com · www.liebherr.com
facebook.com/LiebherrConstruction